



Medical Excellence. Compassionate Care.

Mecklenburg EMS Agency Patient Care Protocols

Doug Swanson, MD, FAEMS, FACEP
Medical Director
Mecklenburg EMS Agency



Mission Statement

*To save a life, hold a hand, and be prepared to respond in our community
when and where our patients need us.*

Table of Contents

Section 1 - Introduction

<u>Title</u>	<u>NCCEP #</u>
<u>Introduction</u>	
<u>Definitions</u>	
<u>Scope of Practice</u>	
<u>NCMB approved EMS Medications</u>	
<u>NCMB approved EMS Skills</u>	
<u>Mecklenburg EMS Agency Scope of Practice</u>	
<u>Scene Response, Patient Categorization, and Hospital Transport</u>	Transport 3
<u>Receiving Hospitals and Patient Destination</u>	
<u>General Triage</u>	
<u>Pediatric Triage</u>	
<u>Stroke Triage</u>	
<u>Cardiac Triage</u>	
<u>Trauma Triage</u>	
<u>Mass Casualty Incident Response</u>	
<u>Triage</u>	UP-2
<u>Medical Scene Control</u>	
<u>Transfer of Care</u>	
<u>On-line Medical Control and Communication</u>	
<u>Bedside Priority Patient Report</u>	
<u>Nonemergency Transport</u>	
<u>Patient Initiated Refusal of Treatment and Transport</u>	
<u>Crime Scenes</u>	
<u>Medical Incident Review Process</u>	

Section 2 – Patient Related Policies

Policy Title	NCCEP #
<u>Criteria for Withholding Resuscitation</u>	Disposition 1
<u>Deceased Subjects</u>	Disposition 2
<u>Discontinuation of Prehospital Resuscitation</u>	Disposition 3
<u>Disposition</u>	Disposition 4
<u>Patient Options Introduced Non-Transport (POINT)</u>	
<u>Facilitated Telemedicine Encounter</u>	
<u>DNR and MOST Forms</u>	Disposition 5
<u>DNR Form</u>	
<u>MOST Form</u>	
<u>Patient without a Protocol</u>	Disposition 6
<u>Physician on Scene</u>	Disposition 7
<u>Physician on Scene Form</u>	
<u>Organ Procurement Agency Notification Policy</u>	Disposition 9
<u>Documentation and Data Quality</u>	Documentation 1
<u>Documentation of Vital Signs</u>	Documentation 2
<u>EMS Dispatch Center Time</u>	EMS Dispatch 1
<u>Children with Special Healthcare Needs</u>	Pediatric 1
<u>Infant Abandonment</u>	Pediatric 2
<u>Child Abuse Recognition and Reporting</u>	
<u>Domestic Violence Recognition and Reporting</u>	
<u>Non-fatal Strangulation</u>	
<u>Human Trafficking Victim Recognition and Reporting</u>	
<u>EMS Back in Service Time</u>	Service Metric 1
<u>EMS Turn-out Time</u>	Service Metric 2
<u>Poison Control Center</u>	Toxic Environmental 1
<u>Air Transportation</u>	Transport 1
<u>Safe Transport of Children</u>	Transport 2

Section 3 – Clinical Patient Care Protocols

Protocol Title	NCCEP #
<u>Glaze</u>	
<u>Initial Approach to Scene</u>	
<u>Universal Patient Care Protocol</u>	UP-1
<u>Medical Initial Assessment</u>	
<u>Trauma Initial Assessment</u>	
<u>Pediatric Initial Assessment</u>	
<u>Pediatric Trauma Assessment</u>	
<u>Airway: Adult</u>	AR-1
<u>Airway: Adult – Failed</u>	AR-2
<u>Airway: Pediatric</u>	AR-5
<u>Airway: Pediatric – Failed</u>	AR-6
<u>Pain Control</u>	UP-11
<u>Medical Monitoring</u>	SO-1/SO-2
<u>Working Fires</u>	
<u>Hazardous Materials</u>	
<u>Police Operations</u>	
<u>Police Custody</u>	
<u>Diving Operations</u>	UP-12
<u>Abdominal Pain</u>	UP-3
<u>Allergic Reaction</u>	AM-1/PM-1
<u>Bites and Envenomations</u>	TE-1
<u>Snake Bite</u>	
<u>Marine Envenomation/Injury</u>	TE-6
<u>Animal Bites</u>	TE-1
<u>Assault</u>	
<u>Back Pain</u>	UP-5
<u>Breathing Problems</u>	
<u>Asthma, COPD, Reactive Airway Disease</u>	AR-4/AR-7
<u>Pulmonary Edema</u>	AC-5/PC-3
<u>Croup</u>	AR-7
<u>Bronchiolitis</u>	
<u>Post Intubation / BIAD Management</u>	AR-8
<u>Emergencies with Ventilators</u>	AR-9
<u>Tracheostomy Tube Emergencies</u>	AR-10
<u>Burns</u>	
<u>Burns – Thermal</u>	TB-9
<u>Burns – Chemical and Electrical</u>	TB-2
<u>Burn Charts</u>	

Protocol Title	NCCEP #
<u>Carbon Monoxide, Cyanide, Hazardous Materials</u>	TE-2
<u>WMD - Nerve Agent Exposure</u>	TE-8
<u>Radiation Incident</u>	TB-7
<u>Cardiac Arrest</u>	AC-3
<u>Ventricular Fibrillation/Pulseless Ventricular Tachycardia</u>	AC-9/PC-6
<u>Torsades</u>	AC-8
<u>Pulseless Electrical Activity</u>	AC-1/PC-1
<u>Asystole</u>	AC-1/PC-1
<u>Traumatic Arrest</u>	TB-10
<u>Post-Resuscitation Care</u>	AC-9/PC-7
<u>Focused Cardiac Arrest</u>	AC-11
<u>Chest Pain – Non Cardiac</u>	
<u>Choking</u>	
<u>Convulsions (Seizures)</u>	UP-13
<u>Diabetic Problems</u>	AM-2/PM-2
<u>Drowning (Submersion) / Diving Injury</u>	TE-3
<u>Electrocution</u>	
<u>Eye Problems</u>	
<u>Falls</u>	
<u>Headache</u>	
<u>Heart Problems</u>	
<u>Chest Pain – Cardiac and STEMI</u>	AC-4
<u>SVT</u>	AC-6/PC-5
<u>Atrial Fibrillation / Atrial Flutter</u>	AC-6/PC-5
<u>Bradycardia</u>	AC-2/PC-2
<u>Wide Complex Tachycardia (VT)</u>	AC-7
<u>Congestive Heart Failure</u>	AC-5/PC-3
<u>Left Ventricular Assist Device</u>	AC-14
<u>Total Artificial Heart</u>	AC-15
<u>LifeVest</u>	AC-16
<u>Heat / Cold Exposure</u>	
<u>Hyperthermia</u>	TE-4
<u>Hypothermia</u>	TE-5
<u>Hemorrhage – Medical Etiology</u>	
<u>Dental Hemorrhage</u>	UP-7
<u>Dialysis Access Hemorrhage</u>	
<u>Epistaxis</u>	UP-9
<u>GI Hemorrhage</u>	
<u>Industrial Accident</u>	

Protocol Title	NCCEP #
<u>Overdose</u>	TE-7
<u>Poison Specific Therapy</u>	
<u>Pregnancy and Childbirth</u>	
<u>Childbirth</u>	AO-1
<u>Newly Born</u>	AO-2
<u>Obstetrical Emergencies</u>	AO-3
<u>Psychiatric</u>	UP-17, 18, 19
<u>Verbal De-escalation Strategies</u>	
<u>Community Policing Crisis Response Team</u>	
<u>Atrium Behavioral Health Charlotte Destination Supplement</u>	
<u>Sick Person</u>	
<u>Sickle Cell Anemia Crisis</u>	
<u>Fever</u>	UP-10
<u>Vomiting and Diarrhea</u>	UP-3
<u>Sepsis</u>	UP-15
<u>Dialysis/Renal Failure</u>	AM-3
<u>Hypertension</u>	AM-4
<u>Hypotension / Shock</u>	AM-5/PM-3
<u>Emergency Involving Indwelling Central Lines</u>	UP-8
<u>Brief Resolved Unexplained Event</u>	
<u>Suspected Viral Hemorrhagic Fever</u>	SC-1
<u>High Consequence Pathogen</u>	SC-2
COVID-19 Specific Protocols in Addendum Section	
<u>Stab Wound</u>	
<u>Stroke</u>	UP-14
<u>Stroke Transfer</u>	AM-6
<u>Traffic Accident</u>	TB-6
<u>Traumatic Injury</u>	TB-6
<u>Head Trauma</u>	TB-5
<u>Blast Injury</u>	TB-1
<u>Crush Trauma</u>	TB-3
<u>Extremity Trauma</u>	TB-4
<u>Impalement Injury</u>	
<u>Unconscious / Syncope</u>	UP-4/UP-16
<u>Unknown Problem</u>	
<u>Transfer - Interfacility</u>	
<u>Gunshot Wound</u>	
<u>Traffic Accident – Pedestrian Struck</u>	TB-6

Section 4 – Clinical Procedures

Procedure	NCCEP #
<u>Airway: BIAD i-Gel</u>	AP-4
<u>Airway: Intubation Orotracheal</u>	AP-6
<u>Airway: Intubation Nasal</u>	AP-7
<u>Airway: Tracheostomy Tube Change</u>	AP-10
<u>Airway: Endotracheal Tube Introducer</u>	AP-11
<u>Airway: Confirmation ETCO₂ Detector</u>	AP-12
<u>Airway: Foreign Body Obstruction</u>	AP-13
<u>Assessment: Adult</u>	ASP-1
<u>Assessment: Pain</u>	ASP-2
<u>Assessment: Pediatric</u>	ASP-3
<u>Blood Glucose Analysis</u>	ASP-4
<u>Capnography</u>	ASP-5
<u>Pulse Oximetry</u>	ASP-6
<u>Stroke Screen: Cincinnati</u>	ASP-8
<u>Temperature Measurement</u>	ASP-9
<u>Orthostatic Blood Pressure</u>	ASP-10
<u>Verbal De-escalation</u>	ASP-11
<u>Zoll X-Series Cardiac Monitor / Defibrillator</u>	
<u>12-Lead ECG</u>	CSP-1
<u>Cardiac: Cardioversion</u>	CSP-2
<u>Cardiac: External Pacing</u>	CSP-3
<u>Cardiac: Cardiopulmonary Resuscitation</u>	CSP-4
<u>Cardiac: Defibrillation - Automated</u>	CSP-5
<u>Cardiac: Defibrillation - Manual</u>	CSP-6
<u>Parenteral Access: Arterial Line Maintenance</u>	PAS-2
<u>Parenteral Access: Venous Blood Draw</u>	PAS-3
<u>Parenteral Access: Cent. Line Maintenance</u>	PAS-4
<u>Parenteral Access: Epidural Maintenance</u>	PAS-5
<u>Parenteral Access: Intraventricular Maintenance</u>	PAS-6
<u>Parenteral Access: Existing Catheters</u>	PAS-7
<u>Parenteral Access: External Jugular Access</u>	PAS-8
<u>Parenteral Access: Venous-Extremity</u>	PAS-9
<u>Parenteral Access: Intraosseous</u>	PAS-11
<u>Parenteral Access: Swan Ganz Maintenance</u>	PAS-12
<u>Airway: Suctioning Advanced</u>	RSP-1
<u>Airway: Suctioning Basic</u>	RSP-2

Protocol Title	NCCEP #
<u>Respiratory: Nebulizer Inhalation Therapy</u>	RSP-3
<u>Respiratory: NIPPV (CPAP)</u>	RSP-4
<u>Respiratory: Respirator Operation</u>	RSP-5
<u>Respiratory: Ventilator Operation</u>	RSP-6
<u>Childbirth</u>	USP-1
<u>Decontamination</u>	USP-2
<u>Gastric Tube Insertion</u>	USP-3
<u>Injections: Subcutaneous and Intramuscular</u>	USP-4
<u>Injections: Intranasal</u>	
<u>Injections: Immunization</u>	
<u>Restraints: Physical</u>	USP-5
<u>Chest Decompression</u>	WTP-1
<u>Spinal Motion Restriction</u>	WTP-2
<u>Splinting</u>	WTP-3
<u>Wound Care-General</u>	WTP-4
<u>Wound Care-Hemostatic Agent</u>	WTP-5
<u>Wound Care-Conducted Electrical Weapon Removal</u>	WTP-6
<u>Wound Care-Tourniquet</u>	WTP-7

Section 5 – Medications

Medication

Medication Formulary Advisory

Acetaminophen (Tylenol®)

Adenosine (Adenocard®)

Albuterol (Proventil®)

Aspirin

Atropine

Calcium Gluconate

Cefazolin (Ancef®)

Dexamethasone

Diltiazem (Cardizem®)

Diphenhydramine (Benadryl®)

Dopamine

Epinephrine

Fentanyl

Glucagon

Glucose

Ibuprofen (Motrin®)

Ketamine (Ketalar®)

Labetalol (Normodyne®)

Lidocaine

Magnesium sulfate

Midazolam (Versed®)

Naloxone (Narcan®)

Nitroglycerin

Nitrous Oxide

Ondansetron (Zofran®)

Oxygen

Sodium bicarbonate

Sodium thiosulfate

Section 6 – Appendix

[START Triage algorithm](#)

[Patient care instructions](#)

[Abbreviations](#)

[Local Credentialing Requirements](#)

[Internal Upgrade Requirements](#)

[Continuing Education Requirements](#)

[Return to Field Requirements](#)

[Clinical Performance Measurements](#)

Supplements

[COVID-19 Specific Supplement](#)

[COVID-19 Focused Cardiac Arrest Supplement](#)

[Monkeypox](#)

*This
Page
Blank*



SECTION 1

Introduction

Introduction

Protocols Sections

1. Introduction
2. Patient Related Policies
3. Clinical Care Protocol
4. Procedure Protocols
5. Medication Formulary (Drug List)
6. Appendix

Updated

- * All Mecklenburg EMS protocols have been reviewed and updated by the Medical Director
- * Contained are revisions of and additions to the Clinical Care Protocols dated: 2/1994, 1/1998, 8/1999, 2/2004, 4/2006, 4/2007, 4/2009, 8/2011, 01/2013, 02/2014, 08/2014, 03/2015, 08/2015, 01/2016, 08/2016, 12/2016, 07/2017, 04/2018, 10/2018, 04/2019, 10/2019, 01/2020, 03/2020, 05/2020, 12/2020, 03/2021, 09/2021, 04/2022, 03/2023

Considerations

- * The Mecklenburg EMS Agency Patient Care Protocols are guidelines designed to provide the practicing prehospital provider at all levels a set of clinical standards for performing quality, competent, and consistent medical care
- * Protocols are designed to follow a continuum of care that is initiated by the Emergency Medical Dispatcher utilizing Medical Priority Dispatch Systems protocols through hospital arrival and coordinate with the North Carolina College of Emergency Physicians protocols
- * Protocols are provided under the authority of:
 - The North Carolina Medical Board
 - The North Carolina Medical Care Commission
 - The North Carolina Office of EMS
 - The Mecklenburg EMS Agency Medical Control Board
 - The Mecklenburg EMS Agency Medical Director
- * These protocols are intended as a guideline for typical care based on patient's complaint and the presumptive diagnosis
- * In individual clinical patient care scenarios, deviation from this guideline may be necessary
 - Discussion with the on-duty Operations Supervisor Field and/or Medical Control Physician must occur prior to any deviation from any protocol
 - Any exception from protocol must be explained within the Patient Care Report to detail reason(s) for deviation
 - Any treatment must remain within the provider's scope of practice
- * Cases will arise that fall outside of any protocol
 - It is the crew's medical decision making that is paramount and is to be used in conjunction with these protocols and consultation with Medical Control
- * Mecklenburg EMS Agency crewmembers may contact Medical Control at any time with any questions regarding patient care

Definitions

Medical Care

- * Basic Medical Care
 - Care eligible for delivery by providers at the EMT level and above
- * Advanced Medical Care
 - Care eligible for delivery by providers at the Paramedic level

Age

- * Pediatric = age \leq 14-years of age (**trauma**)
age \leq 17-years of age (**non-trauma**)
- * Adult = age \geq 15-years of age (**trauma**)
age \geq 18-years of age (**non-trauma**)
- * Geriatric = age \geq 60-years of age

Vital Signs

- * Hypertension
 - Adult
 - Systolic blood pressure $>$ 185 mmHg
 - Diastolic blood pressure $>$ 110 mmHg
- * Hypotension
 - Adult: Systolic blood pressure $<$ 90 mmHg (MAP $<$ 65 mmHg)
 - Pediatric: Systolic blood pressure $<$ 70 + (2*age in years)
- * Tachycardia
 - Adult: Heart rate $>$ 100 beats per minute
 - Pediatric:
 - $<$ 1-year of age: $>$ 160 beats per minute
 - 1-2-years of age: $>$ 150 beats per minute
 - 2-5-years of age: $>$ 140 beats per minute
 - 6-12-years of age: $>$ 120 beats per minute
- * Bradycardia
 - Adult: Heart rate $<$ 60 beats per minute
 - Pediatric
 - $<$ 1-year of age: $<$ 100 beats per minute
 - 1-5 years of age: $<$ 80 beats per minute
 - $>$ 6-years of age: $<$ 60 beats per minute
- * Hypoxia
 - SpO₂ $<$ 90%
- * Fever
 - Temperature $>$ 101.5°F
- * Hypothermia
 - Temperature $<$ 96°F

Mental Status

- * Lethargic / Obtunded
 - Unconscious but arousable
 - Lapses back into unconsciousness without continued stimulation
- * Delusional
 - Experiencing perceptions that are not truly present (hallucinating)
- * Capacity for medical decision making
 - Able to make informed decisions regarding health/healthcare
 - Able to understand the nature and severity of their presumptive illness/injury
 - Able to understand the risks of refusing treatment
 - Including, but not limited to: worsening condition, debilitation, death
 - Able to understand the benefits of receiving medical care
 - NOT under the influence of any mind-altering substance
 - Clear sensorium without delusions or hallucinations
 - Oriented to person, place, time, situation
 - NOT suicidal or homicidal
 - No signs of incoordination
 - No slurred speech
 - NOT medically unstable
 - Including but not limited to: hypotensive, hypoxic, hypoglycemic, clinically intoxicated, significantly tachycardic

Ancillary Testing

- * Hyperglycemia = blood glucose > 300
- * Hypoglycemia = blood glucose < 60

Additional Definitions

- * Patient
 - Any individual who has a physical or medical complaint from illness or injury
- * Patient encounter
 - Contacting an individual who has a medical complaint or potential injury based on mechanism or historical information suggesting an illness or injury [or]
 - Initiating a conversation with a person regarding their health
- * Multiple casualty incident
 - Any incident involving ≥ 3 priority patients (Priority-1 or Priority-2) or ≥ 5 patients of any priority
- * Differential Diagnosis
 - List of potential conditions as the cause of the patient's illness
- * Intubation attempt
 - Insertion of laryngoscope blade past the patient's teeth during the procedure; regardless of whether an attempt is made to insert the endotracheal tube

Scope of Practice

Introduction

- * Scope of practice describes the clinical skills that may be performed and the medications that may be administered by a healthcare provider
- * The North Carolina Medical Board has the responsibility of defining the scope of medical practice for prehospital providers at all certification levels in North Carolina
- * Local medical control has the final decision on the skills and medications that will be utilized by the EMS agency from the NCMB lists
- * All Mecklenburg County prehospital personnel must adhere to the local standards outlined in these protocol guidelines
- * Only EMT or Paramedic students that have satisfied each of the following will be permitted to perform beyond their current scope of practice:
 - The student is currently enrolled and considered in good standing with an EMT or Paramedic training program that has officially affiliated with the Agency
 - Appropriate scheduling arrangements have been previously made with Operations
 - The student is assigned to and under the direct supervision of a designated Mecklenburg EMS Agency Field Training Officer or Paramedic Preceptor and is functioning as a third crew member in the "student" (non-paid provider) capacity
- * Any Mecklenburg EMS Agency provider or affiliated first responder not practicing within the scope of medical practice as outlined by the North Carolina Medical Board and the Mecklenburg EMS Agency, encouraging this practice, or tolerating such behavior may be removed from patient care activities

**TITLE 10 – DEPARTMENT OF HEALTH AND HUMAN SERVICES
CHAPTER 13 – FACILITY SERVICES
SUBCHAPTER 13P – EMERGENCY MEDICAL SERVICES
SECTION .0500 – EMS PERSONNEL**

10A NCAC 13P .0505 SCOPE OF PRACTICE FOR EMS PERSONNEL

EMS Personnel educated in approved programs, credentialed by the OEMS, and functioning under physician medical oversight may perform acts and administer intravenous fluids and medications as allowed by the North Carolina Medical Board pursuant to G.S. 143-514.

*History Note: Authority G.S. 143-508(d)(6); 143-514;
Temporary Adoption Eff. January 1, 2002;
Eff. April 1, 2003;
Pursuant to G.S. 150B-21.3A, rule is necessary without substantive public interest Eff.
February 2, 2016;
Amended Eff. July 1, 2018.*

NCMB Approved Medications for Credentialed EMS Personnel

Medications	EMR	EMT	AEMT	MEDIC
ACE inhibitors				X
Acetaminophen	X	X	X ¹⁵	X
Adenosine				X
Aminophylline				X
Amiodarone				X
Anti-arrhythmic				X ¹²
Antibiotics				X
Anti-emetic preparations				X
Antivirals				X
Aspirin	X	X	X	X
Atropine	X ⁴	X ⁴	X ⁴	X
Barbiturates				X
Benzodiazepine preparations				X ¹⁴
Beta agonist preparations		X ²	X	X
Beta blockers				X ¹³
Bretylium				X
C1 Esterase-Inhibitors				X
Calcium channel blockers				X ¹³
Calcium chloride/gluconate				X
Charcoal		X	X	X
Clonidine				X
Clopidogrel				X
CroFab (Crotalidae Polyvalent Immune Fab)				X ⁸
Crystalloid solutions			X	X
Cyanide poisoning antidote kit				X
Digoxin				X
Diphenhydramine	X ³	X ³	X	X
Diuretics				X
Dobutamine				X
Dopamine				X
Droperidol				X
Epinephrine	X ¹	X ¹	X	X
Etomidate				X
Flumazenil				X
Glucagon			X	X

Last revision: June 28, 2022

Medications	EMR	EMT	AEMT	MEDIC
Glucose, oral	X	X	X	X
Glucose solutions			X	X
Haloperidol				X
Heparin (unfractionated and low molecular weight)				X
Histamine 2 blockers			X	X
Hydroxocobalamin				X
Immunizations			X ⁶	X ⁶
Ipratropium			X	X
Isoproterenol				X
Ketamine				X ⁷
Levetiracetam				X
Lidocaine			X ¹⁸	X
Magnesium sulfate				X
Mannitol				X
Methylene blue				X
Milrinone				X
N-acetylcysteine				X
Narcotic analgesics				X
Narcotic antagonists	X ^{9,10}	X ^{9,10}	X	X
Nasal spray decongestant		X	X	X
Nesiritide				X
Nitroglycerin		X ²	X	X
Nitroprusside sodium				X
Nitrous oxide				X
Non-prescription medications		X	X	X
Non-steroidal anti-inflammatory		X	X ¹⁵	X
Norepinephrine				X
Octreotide				X
Oxygen	X ⁵	X ⁵	X ⁵	X ⁵
Oxytocin				X
Paralytic agents				X ¹⁷
Phenothiazine preparations				X
Phenylephrine				X
Phenytoin preparations				X
Plasma protein fraction				X

Last revision: June 28, 2022

Medications	EMR	EMT	AEMT	MEDIC
Platelet g-II/IIIa inhibitors				X
Potassium chloride				X
Pralidoxime	X ⁴	X ⁴	X ⁴	X
Procainamide				X
Procaine				X
Proparacaine				X
Propofol				X ⁸
Sodium bicarbonate				X
Steroid preparations				X
Thiamine			X	X
Thrombolytic agents				X
Topical hemostatic agents	X	X	X	X
Total Parenteral Nutrition				X
Tranexamic Acid (TXA)				X ¹¹
Tuberculosis skin test			X ⁶	X ⁶
Valproic acid				X
Vasopressin			X	X
Vasopressor				X ¹⁶
Whole blood and components				X
Ziprasidone				X

Last revision: June 28, 2022

1. EMR and EMT use of epinephrine is limited to the treatment of anaphylaxis administered only by auto injector, unless approved by EMS System Medical Director and OEMS.
2. EMT use of beta-agonists and nitroglycerin is limited to patients who currently are prescribed the medication unless approved by the EMS System Medical Director and OEMS as part of the expanded scope.
3. EMR/EMT administration of diphenhydramine is limited to the oral route.
4. As a component of preparedness for domestic terrorism, EMS personnel, public safety officers, and other first responders recognized by the EMS system, may carry, self-administer, or administer to a patient atropine and/or pralidoxime, based on written protocols and medical direction. All personnel except for Paramedics must administer these medications by an auto injector.
5. Administration of oxygen does not require medical direction.
6. Administration of immunizations and TB skin tests are not limited to public health initiatives.
7. Ketamine use is restricted to programs approved by the OEMS State Medical Director. It can be used as an induction or post intubation sedation agent in approved DAI programs. Use outside of DAI programs must meet all the requirements outlined in Medical Policy 2 'Ketamine Program Requirements'.
8. Propofol use is restricted to programs approved by the OEMS State Medical Director. EMS Systems and SCTP's must submit a policy and education plan to the OEMS prior to approval. EMS personnel cannot initiate Propofol; it can only be used for interfacility transport where infusion has already been started at transferring facility. EMS units cannot stock Propofol or CroFab. This medication must be provided by the transferring hospital.
9. FR, EMR, and EMT administration of Naloxone is limited to the intra-nasal (IN), intra-muscular (IM), and auto-injector routes.
10. First Responders (FR) who administer Naloxone must do so under the medical oversight of the County EMS Medical Director, following protocols and procedures approved by the OEMS State Medical Director.
11. For an EMS System to use Tranexamic Acid (TXA), they must submit for approval by the OEMS State Medical Director a signed letter from any Trauma Centers that would be the recipient of the patient that the destination Trauma Center agrees with its use and will give the 2nd required dose of Tranexamic Acid (TXA).
12. All Paramedic systems must carry some form of anti-arrhythmic agent.
13. Paramedic systems must carry either a calcium channel blocker or beta-blocker.
14. All Paramedic systems must carry some form of injectable benzodiazepine.
15. AEMT systems must carry either acetaminophen or a non-steroidal anti-inflammatory.
16. All Paramedic systems must carry an approved vasopressor. This must either be dobutamine, dopamine, epinephrine, norepinephrine, phenylephrine, or vasopressin.
17. Paralytic agent use is restricted to Drug Assisted Intubation (DAI) programs approved by the OEMS State Medical Director. They require the submission of; signed NCCEP DAI policy by local medical director, unaltered NCCEP DAI protocols, training documentation, and process for peer review of cases. All DAI must have an EMS Airway Evaluation form completed and signed by local medical director in accordance with the NCCEP DAI policy. Systems utilizing must submit monthly airway forms and cases to the OEMS for review.
18. AEMT administration of Lidocaine is allowed for analgesic use only.

NCMB Approved EMS Skills Approved Skills for EMS Personnel

Skills	EMR	EMT	AEMT	MEDIC
12-Lead ECG Acquisition & Transmission		X	X	X
12-Lead ECG Interpretation				X
15-Lead ECG Acquisition				X
Airway Adjuncts (NPA/OPA)	X	X	X	X
Arterial Access - Blood Draw				X
Arterial Line maintenance				X
Blind Insertion Airway Device (BIAD)	X ¹	X ¹	X	X
Capnography (Waveform)	X ⁶	X ⁶	X ⁶	X ⁶
Carbon Monoxide Measurement (non-invasive)	X	X	X	X
Cardiac Monitoring		X ⁴	X ⁴	X
Cardiac Pacing				X
Cardiopulmonary Resuscitation	X	X	X	X
Cardioversion				X
Carotid Massage				X
Central Venous Pressure Line Maintenance				X
Chest Compression-External Device	X	X	X	X
Chest Decompression-Needle				X
Chest Tube Maintenance				X
Childbirth	X	X	X	X
Cricothyrotomy-Needle				X
Cricothyrotomy-Surgical				X ⁵
Decontamination	X	X	X	X
Defibrillation-Automated	X	X	X	X
Defibrillation-Manual				X
Direct Laryngoscopy			X	X
Drug Assisted Intubation (DAI)				X ^{5,6}
Endotracheal Tube Introducer			X	X
Epidural Catheter Maintenance				X
Foreign Body Airway Obstruction	X	X	X	X
Gastric Intubation		X ³	X ³	X
Glucose Measurement	X	X	X	X
Hemostatic Agent	X	X	X	X
Injections – Subcutaneous and Intramuscular		X ²	X	X
Intra-Ventricular Catheter Maintenance				X

Last revision: June 28, 2022

Skills	EMR	EMT	AEMT	MEDIC
Intubation - Nasotracheal			X	X
Intubation - Orotracheal			X ⁶	X ^{6,7}
Intubation Confirmation - Capnometry (color)			X	X
Medication Administration	X ²	X ²	X ²	X ²
Nebulizer Inhalation Therapy		X	X	X
Non-Invasive Positive Pressure Ventilation	X ⁹	X	X	X
Orthostatic Blood Pressure	X	X	X	X
Oxygen Administration	X	X	X	X
Patient Assessment	X	X	X	X
Pulse Oximetry	X	X	X	X
Reperfusion Checklist	X	X	X	X
Respirator Operation		X	X	X
Restraints		X	X	X
Specimen Collection		X	X	X
Spinal Motion Restriction	X	X	X	X
Splinting	X	X	X	X
Stroke Screen	X	X	X	X
Suction-Basic	X	X	X	X
Suction-Advanced			X ¹⁰	X ¹⁰
Swan-Ganz Catheter maintenance				X
Taser Probe Removal	X	X	X	X
Temperature Measurement	X	X	X	X
Tourniquet Application	X	X	X	X
Tracheostomy Tube Change			X	X
Urinary Catheterization				X
Venous Access-Blood Draw			X	X
Venous Access-Existing catheters				X
Venous Access-Femoral Line				X
Venous Access-Intraosseous			X	X
Venous Access-Peripheral			X	X
Ventilator Operation		X ⁸	X ⁸	X
Wound Care	X	X	X	X

Last revision: June 28, 2022

1. EMRs and EMTs using blind insertion airway devices must be functioning in EMS systems with medical direction and written treatment protocols.
2. EMS personnel educated in approved programs, credentialed by the OEMS, and functioning under physician medical oversight may perform acts and administer intravenous fluids and medications as allowed by the North Carolina Medical Board pursuant to G.S. 143-514. The administration of oxygen does not require medical direction.
3. Gastric tube insertion may be performed only when utilized in conjunction with a blind insertion airway device.
4. EMT and AEMT may use the cardiac monitor for vital sign monitoring and EKG transmission.
5. Systems performing drug assisted intubation (DAI) must have the ability to perform surgical cricothyrotomy. Commercial cricothyrotomy or tracheostomy kits that create an airway comparable to a surgical cricothyrotomy are acceptable.
6. End-tidal (EtCO₂) monitoring is mandatory following placement of an endotracheal tube. EtCO₂ monitoring is mandatory following placement of a BIAD once available on scene.
7. Pediatric intubation is an optional skill/procedure.
8. Ventilator patients may be transported by EMT/AEMT when all of the following conditions are met:
 - a. Patient is receiving home (or skilled nursing) ventilator therapy.
 - b. The ventilator is portable and can continue to ventilate the patient during transport.
 - c. The patient is accompanied by a non-EMS adult (from either the home or facility) who is knowledgeable, capable, and willing to maintain the ventilator during the EMS transport.
 - d. While in transit, the patient is monitored using pulse oximetry.
9. Bag Valve Mask ONLY
10. For a patient currently being assisted by an airway adjunct such as a naso-tracheal tube, endotracheal tube, BIAD, tracheostomy tube or a cricothyrotomy tube.

10A NCAC 13P .0403 RESPONSIBILITIES OF THE MEDICAL DIRECTOR FOR EMS SYSTEMS

(a) The Medical Director for an EMS System is responsible for the following:

- (1) ensuring that medical control as set forth in Rule .0401(5) of this Section is available 24 hours a day, seven days a week;
- (2) the establishment, approval, and annual updating of adult and pediatric treatment protocols;
- (3) EMD programs, the establishment, approval, and annual updating of the Emergency Medical Dispatch Priority Reference System;
- (4) medical supervision of the selection, system orientation, continuing education and performance of all EMS personnel;
- (5) medical supervision of a scope of practice performance evaluation for all EMS personnel in the system based on the treatment protocols for the system;
- (6) the medical review of the care provided to patients;
- (7) providing guidance regarding decisions about the equipment, medical supplies, and medications that will be carried on all ambulances and EMS nontransporting vehicles operating within the system;
- (8) determining the combination and number of EMS personnel sufficient to manage the anticipated number and severity of injury or illness of the patients transported in Medical Ambulance/Evacuation Bus Vehicles defined in Rule .0219 of this Subchapter;
- (9) keeping the care provided up-to-date with current medical practice; and
- (10) developing and implementing an orientation plan for all hospitals within the EMS system that use MICN, EMS-NP, or EMS-PA personnel to provide on-line medical direction to EMS personnel. This plan shall include:
 - (A) a discussion of all EMS System treatment protocols and procedures;
 - (B) an explanation of the specific scope of practice for credentialed EMS personnel, as authorized by the approved EMS System treatment protocols required by Rule .0405 of this Section;
 - (C) a discussion of all practice settings within the EMS System and how scope of practice may vary in each setting;
 - (D) a mechanism to assess the ability to use EMS System communications equipment, including hospital and prehospital devices, EMS communication protocols, and communications contingency plans as related to on-line medical direction; and
 - (E) the completion of a scope of practice performance evaluation that verifies competency in Parts (A) through (D) of this Subparagraph and that is administered under the direction of the Medical Director.

(b) Any tasks related to Paragraph (a) of this Rule may be completed, through the Medical Director's written delegation, by assisting physicians, physician assistants, nurse practitioners, registered nurses, EMDs, or paramedics.

(c) The Medical Director may suspend temporarily, pending review, any EMS personnel from further participation in the EMS System when he or she determines that the individual's actions are detrimental to the care of the patient, the individual committed unprofessional conduct, or the individual failed to comply with credentialing requirements.

During the review process, the Medical Director may:

- (1) restrict the EMS personnel's scope of practice pending completion of remediation on the identified deficiencies;
- (2) continue the suspension pending completion of remediation on the identified deficiencies; or
- (3) permanently revoke the EMS personnel's participation in the EMS System.

History Note: Authority G.S. 143-508(b); 143-508(d)(3); 143-508(d)(7);
Temporary Adoption Eff. January 1, 2002;
Eff. April 1, 2003;
Amended Eff. January 1, 2009; January 1, 2004;
Readopted Eff. January 1, 2017.

Mecklenburg EMS Agency Scope of Practice

EMT

* Procedures and Skills

- 4-lead & 12-lead ECG acquisition
- Airway: Bag-Valve-Mask ventilation
- Airway: Blind Insertion Airway Device (BIAD)
- Airway: suctioning
- Capnography – waveform
- Cardiopulmonary Resuscitation (CPR)
- Childbirth
- Decontamination
- Defibrillation – Automated (AED)
- Foreign Body Airway Obstruction removal
- Gastric tube insertion via BIAD
- Glucose measurement
- Injection – intramuscular (IM)
- Nebulizer administration – only patients with current prescription for beta agonist)
- Patient assessment
- PRN adapter monitoring
- Restraints application
- Spinal motion restriction
- Splinting of fractures
- Vital signs (including SpO₂, CO, temperature & orthostatic vital signs)
- Wound care (including tourniquet, chest seal, & CEW probe removal)

* Medications

- Oral medications
 - Acetaminophen (Tylenol®)
 - Aspirin
 - Diphenhydramine (Benadryl®)
 - Glucose (InstaGlucose®)
 - Nitroglycerin SL (Nitrostat®) – only patients with current prescription
- Inhalational medications
 - Albuterol (Proventil®)
 - Oxygen
- Intramuscular medications
 - Atropine via auto-injector in Mark-1® or DuoDote® antidote kits
 - Epinephrine 1:1,000 via draw and administer
 - Epinephrine 1:1,000 via auto-injector (EpiPen®)
 - Epinephrine 1:2,000 via auto-injector (EpiPen Jr®)
 - Pralidoxime via auto-injector in Mark-1® or DuoDote® antidote kits
- Intranasal medications
 - Naloxone (Narcan®)

Paramedic

* Procedures and Skills

- 4-lead & 12-lead ECG acquisition & interpretation
- Airway: Bag-Valve-Mask ventilation
- Airway: Blind Insertion Airway Device (BIAD)
- Airway: Endotracheal intubation (adult only)
- Capnography – waveform
- Cardiac Pacing – Transcutaneous
- Cardiopulmonary Resuscitation (CPR)
- Cardioversion
- Chest needle decompression
- Childbirth
- Decontamination
- Defibrillation – Automated (AED)
- Defibrillation – Manual
- Foreign Body Airway Obstruction removal
- Gastric tube insertion
- Glucose measurement
- Injection – intramuscular (IM)
- Nebulizer administration
- Non-invasive positive airway pressure (CPAP)
- Patient assessment
- Restraints application
- Spinal motion restriction
- Splinting of fractures
- Suctioning
- Vital signs (including SpO₂, CO, temperature & orthostatic vital signs)
- Venous access – Peripheral, Intraosseous, or External Jugular
- Wound care (including tourniquet, chest seal, & CEW probe removal)

* Medications

- Oral medications
 - Acetaminophen (Tylenol®)
 - Aspirin
 - Diphenhydramine (Benadryl®)
 - Glucose (InstaGlucose®)
 - Nitroglycerin (Nitrostat®)
 - Ondansetron (Zofran®)
- Topical medications
 - Nitroglycerin ointment (Nitrol® ointment)
- Inhalational medications
 - Albuterol (Proventil®)
 - Epinephrine (racemic)
 - Nitrous oxide (N₂O)
 - Oxygen
- Intramuscular medications
 - Atropine via auto-injector in Mark-1® or DuoDote® antidote kits
 - Diphenhydramine (Benadryl®)
 - Epinephrine 1:1,000
 - Epinephrine 1:1,000 via auto-injector (EpiPen®)
 - Epinephrine 1:2,000 via auto-injector (EpiPen Jr®)
 - Glucagon (GlucaGen®)
 - Ketamine (Ketalar®)
 - Midazolam (Versed®)
 - Naloxone (Narcan®)
 - Ondansetron (Zofran®)
 - Pralidoxime via auto-injector in Mark-1® or DuoDote® antidote kits
- Intranasal medications
 - Fentanyl
 - Midazolam (Versed®)
 - Naloxone (Narcan®)

- Intravenous medications
 - Adenosine (Adenocard®)
 - Atropine
 - Calcium gluconate
 - Cefazolin (Ancef®)
 - dexamethasone
 - Dextrose
 - Diltiazem (Cardizem®)
 - Diphenhydramine (Benadryl®)
 - Dopamine
 - Epinephrine 1:10,000
 - Fentanyl
 - Glucagon (GlucaGen®)
 - Labetalol (Normodyne®)
 - Lidocaine
 - Magnesium sulfate
 - Midazolam (Versed®)
 - Naloxone (Narcan®)
 - Ondansetron (Zofran®)
 - Sodium bicarbonate
 - Sodium thiosulfate

Paramedic – Special Operations

* Medications

- Paramedic list with the following also included:
- Oral medications
 - Aluminum/magnesium hydroxide + simethicone (Maalox Plus®)
 - Bismuth subsalicylate (Pepto-Bismol®)
 - Ibuprofen (Motrin®)
 - Pseudoephedrine & Guaifenesin
- Topical medications
 - Bacitracin ointment
 - Hemostatic agents
- Intraocular medications
 - Tetracaine 0.5% (Pontocaine®)
- Inhalational medications
 - Paramedic list
- Intramuscular medications
 - Paramedic list
- Intranasal medications
 - Paramedic list
- Intravenous medications
 - Paramedic list

Scene Response, Patient Categorization, and Hospital Transport

Scene Response

- * Following the CMED call-taking processes, each request for service will be assigned a priority designation based on the Medical Priority Dispatch System sub-determinant
- * Predetermined response configurations and vehicle response modes have been designated for each individual call sub-determinant with appropriate upgrades for simultaneous incoming calls per local medical control
 - All vehicle response modes assigned by CMED will be followed
- * To upgrade the response to a higher priority, the Crew Chief must confer with CMED Control or the Operations Supervisor Communications
- * The call priority and vehicle response mode for responding to the scene of an incident will be defined as follows:

<u>Category</u>	<u>Description</u>	<u>Response Mode</u>
Echo	Emergency, Life-threatening	Warning lights & siren indicated
Delta	Emergency, Life-threatening	Warning lights & siren indicated
Charlie	Emergency, NON-life-threatening	Warning lights & siren indicated
Bravo (hot)	Emergency, NON-life-threatening	Warning lights & siren indicated
Bravo (cold)	NON-emergency	Warning lights & siren NOT indicated
Alpha	NON-emergency	Warning lights & siren NOT indicated
NET	Scheduled	Warning lights & siren NOT indicated

- * In the event of a multiple casualty incident or disaster response, the above protocols may be changed to better insure adequate availability of resources

Patient Categorization

- * The Crew Chief will always be responsible for patient assessment, clinical decision-making, and treatment algorithms (per protocol) for all patients encountered
- * Following the focused (primary), detailed (secondary) assessments, and critical intervention(s), patient categorization will be determined and assigned by the Crew Chief based on patient condition
- * Patient categorization will be defined as follows:

<u>Category</u>	<u>Description</u>	<u>Definition & Transport Mode</u>
Priority-1	Emergent	Immediately life-threatening / high potential for decompensation Warning lights & siren indicated
Priority-2	Urgent	Not life-threatening / intermediate potential for decompensation Warning lights & siren MAY be indicated
Priority-3	Non-urgent	Non-emergent / Minimal potential for decompensation Warning lights & siren NOT indicated
Priority-4	Scheduled	Non-emergent / Minimal potential for decompensation Warning lights & siren NOT indicated

Priority-1 Medical Examples

- * Acute cerebrovascular accident categorized as CODE STROKE with FAST-ED score ≥ 3
- * Acute myocardial infarction categorized as CODE STEMI
- * Airway compromise or severe respiratory distress
 - Patient requiring CPAP
 - Patient requiring emergent intubation
 - Status asthmaticus
- * Altered mental status with GCS ≤ 8
- * Anaphylaxis – without improvement with epinephrine
- * Hemodynamically unstable
- * Imminent delivery (term or pre-term)
- * Rapidly deteriorating condition
- * Severe abdominal or back pain with concern for abdominal aortic aneurysm
- * Shock index > 1 and hypotension in suspected bacterial infection (Code Sepsis)
- * Status epilepticus
- * Unconscious and hemodynamically unstable

Priority-2 Medical Examples

- * Acute coronary syndrome NOT categorized as CODE STEMI
- * Altered mental status with GCS 9 – 13
- * Anaphylaxis – improved with epinephrine
- * Cerebrovascular accident classified as CODE STROKE with FAST-ED score 0 – 2
- * Cerebrovascular accident NOT categorized as CODE STROKE
- * Moderate (NON-anaphylaxis) allergic reaction
- * Respiratory distress NOT requiring emergent intubation or CPAP
- * Severe abdominal pain NOT associated with a pulsatile intra-abdominal mass
- * Shock index > 1 without hypotension in suspected bacterial infection (Sepsis Alert)

Priority-3 Medical Examples

- * Chest pain, unknown etiology
 - Not consistent with acute coronary syndrome or pulmonary embolus
- * Chronic abdominal or back pain
- * Constitutional symptoms (weak, dizzy, lightheaded, cold or flu-like symptoms)
- * Headache
- * Mild allergic reaction
- * Respiratory distress relieved after appropriate treatment(s)
- * Seizure history – postictal or fully awake

Priority Trauma Examples

- * See specific guidelines listed with Trauma Triage Destination Protocol

Transport

- * Adult patients will always be transported on the ambulance stretcher using the 2 shoulder and 3 body straps
- * If patient refuses to be transported on the stretcher, this will be documented on the PCR
- * It is recommended that all patients be loaded into and moved out of the ambulance on the stretcher
 - When it is determined that the patient can enter the ambulance on their own, assistance will always be provided
- * The squad bench and captain's chair will only be used when more than one patient is transported (or when the patient refuses to be transported on the stretcher)
- * All patients will be appropriately secured with seat belts
- * Pediatric patients (birth to 40 pounds) will always be secured in a standard infant car seat
 - The car seat will only be secured to the stretcher or the captain's chair, and will never be secured to the squad bench
- * If infant patients require spinal motion restriction, a standard infant car seat may be used
 - Additional padding will be used to reinforce motion restriction of the cervical spine
- * Medical equipment in the patient compartment will be secured with straps or seat belts to reduce the potential for patient or provider injury should sudden deceleration occur

Additional Considerations

- * Scene Times
 - Priority-1 trauma scene time goal is < 10 minutes
 - Code STEMI and Code Stroke scene time goal is < 15 minutes
 - Interfacility bedside time goal is < 15 minutes
 - Any requirement or unusual circumstances for longer scene / bedside times should be indicated on the PCR
- * Interfacility transfers should be transported in timely efficient manor to the receiving hospital with mode (routine traffic or lights & siren) dependent on patient condition
 - Utilize Priorities as outlined in medical priorities (listed above) or trauma priorities (listed in trauma triage categorization)
- * Priority-1 or 2 Trauma Patients with need for emergent intervention (e.g. emergent need for airway intervention unable to be performed in the field) may be diverted to the closest appropriate facility for that intervention with subsequent continuance to the originally intended facility
- * In extreme circumstances a patient may be transported by a non-transport vehicle
 - The reason for such transport must be clearly documented

Receiving Hospitals and Patient Destination

Receiving facility for patients transported by the Mecklenburg EMS Agency will be any healthcare facility emergency department in Mecklenburg County

* Atrium Health Behavioral Health Charlotte ##	Charlotte
* Atrium Health Carolinas Medical Center	Charlotte
* Atrium Health Huntersville **	Huntersville
* Atrium Health Mercy	Charlotte
➤ <i>no obstetric services (if patient > 20-weeks EGA)</i>	
* Atrium Health Mountain Island**	Charlotte
* Atrium Health Pineville	Pineville
* Atrium Health Providence **	Charlotte
* Atrium Health South Park **	Charlotte
* Atrium Health Steele Creek **	Charlotte
* Atrium Health University City	Charlotte
* Novant Health Ballantyne	Charlotte
* Novant Health Huntersville Medical Center	Huntersville
* Novant Health Matthews Medical Center	Matthews
* Novant Health Mint Hill Medical Center	Mint Hill
* Novant Health Presbyterian Medical Center	Charlotte

Patients may request transport to hospitals (ED's) outside of Mecklenburg County

* Atrium Health Cabarrus	Concord, NC
* Atrium Health Harrisburg **	Harrisburg, NC
* Atrium Health Lincolnton	Lincolnton, NC
* Atrium Health Union	Monroe, NC
* Atrium Health Union West	Stallings, NC
* Atrium Health Waxhaw **	Waxhaw, NC
* CaroMont Regional Medical Center	Gastonia, NC
* CaroMont Regional Medical Center Mount Holly **	Mount Holly, NC
* Lake Norman Regional Medical Center	Mooresville, NC
* Piedmont Medical Center	Rock Hill, SC
* Piedmont Medical Center Fort Mill	Fort Mill, SC
* Piedmont Medical Center Gold Hill **	Rock Hill, SC

- * Out-of-county requests may be honored only when system status will allow and is approved by CMED or the on-duty Operations Supervisor
- * Secondary or NET transport to facilities outside of Mecklenburg County may be performed

See specific inclusion/exclusion destination criteria for the following designations:

Facility is a Behavioral Health Emergency Department

** Facility is a Freestanding Emergency Department

General Triage

1. ADULT patients categorized as **Priority-1 Medical** will be transported to the closest network system (Atrium Health or Novant Health) hospital emergency department requested by the patient/family
 - A. Patients not having a preference or unable to communicate their preference will be transported to the closest hospital emergency department in MECKLENBURG COUNTY per mapping data
 - B. Exceptions: CODE STEMI, CODE STROKE, Cardiac arrest with ROSC in the field (refer to specific triage destination below for each of these patient types)
 2. ADULT Patients categorized as **Priority-2 Medical, Priority-3 Medical** or **Priority-3 Trauma** may be transported to any hospital or free-standing emergency department
 - A. Choice of receiving hospital will be based on the following order:
 - i. Patient/family preference
 - ii. Patients not having a facility preference or unable to communicate their preference will be transported to the closest emergency department in MECKLENBURG COUNTY per mapping data
 3. Free-standing emergency departments
 - A. Indications for transport to free-standing ED (FSED)
 - i. **Priority-2 Medical, Priority-3 Medical** or **Priority-3 Trauma**
 - ii. **Priority-1 Medical** or **Priority-1 Trauma** with emergent interventions required to sustain life (e.g. airway intervention, hemorrhage control)
 - iii. **Priority-1 Medical** or **Priority-1 Trauma** where death is imminent or obvious regardless of further resuscitative efforts (e.g. cardiac arrest without ROSC)
 - B. Contraindications to transport to a free-standing ED
 - i. Pregnancy > 20-weeks estimated gestational age
 - Patients with imminent birth or birth complication should only be transported to FSED if facility is critically closer than a hospital ED
 - ii. CODE STEMI, cardiac arrest with ROSC in field, CODE Stroke
 - iii. Patient with a high likelihood of requiring hospital admission
 - iv. Patients requiring physical restraint due to combativeness
 - C. If unclear about destination decisions regarding a hospital versus free-standing emergency department, contact medical control for consultation
 4. For the initial evaluation, patients will only be transported to an emergency department
 - A. If it is subsequently determined that another facility such as a specialty care center or private office (e.g. eye injury requiring specialized diagnostic tools or equipment) is indicated, it is permissible to transport to that designated location
 - i. Such cases will be determined by the initial receiving emergency physician, and appropriate arrangements and communication between physicians and facilities will be established prior to transport
 - ii. Destination facility must be confirmed prior to departing referring facility
 5. Prescheduled, nonemergency transports for medical or therapeutic appointments may be transported to that predesignated facility
- * *Prehospital personnel will refrain from persuading patient's destination decision*

Emergency Departments on Diversion

1. There may be times when one or more hospitals or freestanding emergency departments are unable to receive patients; either in general or those with a specific clinical condition and request to be on diversion as an EMS destination
2. When an emergency department(s) issues such requests and unless directed otherwise, personnel will utilize the following guidelines:
 - A. Trauma Triage Protocol will remain in place for **Priority-1** and **Priority-2 Trauma** patients
 - B. **Priority-1 Medical** patients will always be transported to the closest facility within with requested healthcare system if needed for emergent intervention (e.g. airway) regardless of the request issued by the Emergency Department
 - C. **Priority-1 Medical, Priority-2 Medical** and **all Priority-3** patients will be transported to an alternate destination
 - D. **Priority-1** and **Priority-2 Pediatric Medical** patients will only be transported to a children's emergency department
 - E. If the emergency department requesting the diversion status offers an alternate receiving facility, that information will be provided to the patient
 - i. The patient has the option to select the recommended facility or choose another facility based on their preference
 - ii. Patients not having a preference will be transported to the closest facility
 - This will occur regardless of possible change in healthcare system
 - F. Patients adamantly insisting on transport to a facility that has issued a diversion request will be transported to that facility regardless of the facility request
 - i. This must be clearly communicated with the facility
3. Only Medical Control at the final receiving facility should be contacted

Interfacility Transports

- * **Patients with an established physician–patient relationship - includes interfacility transfers, private physician office/clinic, urgent care center, etc.**
1. Crew will confer with patient together with the physician or staff to confirm patient destination prior to departing the facility
 - A. If the patient changes their destination decision after departing the hospital/office/clinic/urgent care center, immediately contact the referring facility to discuss the patient's requested change of destination
 - B. If accepted by the referring staff, the original destination facility (if previously made aware of and expecting the patient), must also be notified of the patient's destination change as requested by the patient
 2. If patient condition changes while enroute such that it necessitates a change in destination, this also must be communicated as soon as possible to the referring and initial receiving facilities (e.g. patient develops ST-segment elevation in route necessitating diversion to a PCI capable hospital)
- * *Prehospital personnel will refrain from persuading a patient's decision*

Pediatric Triage

1. PEDIATRIC patients categorized as **Priority-1** or **Priority-2 Medical** or **Pediatric Code-600** will be transported to either Atrium Health Levine Children's Hospital or Novant Health Presbyterian Medical Center Hemby Children's Hospital
 2. Choice of receiving hospital will be based on the following order:
 - A. Patient/family preference (healthcare system)
 - B. Patients not having a preference or unable to communicate their preference will be transported to the closest children's hospital emergency department in MECKLENBURG COUNTY per mapping data
 3. PEDIATRIC Patients categorized as **Priority-3 Medical** or **Priority-3 Trauma** or may be transported to any hospital or freestanding emergency department
 4. Choice of receiving hospital will be based on the following order:
 - A. Patient/family preference
 - B. Patients not having a facility preference or unable to communicate their preference will be transported to the closest emergency department in MECKLENBURG COUNTY per mapping data
 5. Patients requiring emergent intervention (airway management, ongoing CPR, or other critical resuscitative need) should be transported to the closest emergency department
- * *Prehospital personnel will refrain from persuading a patient's decision*

Stroke Triage

1. Patients considered to be having an acute cerebrovascular accident (CVA) and categorized as **CODE STROKE** will be transported to a hospital emergency department only
 2. Patients with a **FAST-ED score ≥ 6** will be transported to either Atrium Health Carolinas Medical Center or Novant Health Presbyterian Medical Center
 - A. Choice of receiving hospital will be based on the following order:
 - i. Patient/family preference
 - ii. Patients not having a preference or unable to communicate their preference will be transported to the closer of these comprehensive stroke centers per mapping data
 3. Patients with a **FAST-ED score 0 – 5** will be transported to any hospital emergency department
 - A. Choice of receiving hospital will be based on the following order:
 - i. Patient/family preference
 - ii. Patients not having a preference or unable to communicate their preference will be transported to the closest hospital emergency department in MECKLENBURG COUNTY per mapping data
 4. The Medical Control physician (or designee) at the destination hospital of a CODE STROKE patient will be notified IMMEDIATELY once the categorization and the destination hospital are determined
- * *Prehospital personnel will refrain from persuading a patient's decision*

Cardiac – Code STEMI Triage

1. Patients considered to be having an acute myocardial infarction will be categorized as **CODE STEMI** and shall only be transported to hospitals with interventional cardiac catheterization capabilities available 24 hours per day 7 days per week for primary coronary intervention (PCI)
2. Mecklenburg County PCI facilities:
 - * Atrium Health Carolinas Medical Center
 - * Atrium Health Pineville
 - * Novant Health Huntersville Medical Center
 - * Novant Health Matthews Medical Center
 - * Novant Health Presbyterian Medical Center
3. The choice of PCI center will be based on the following (in order):
 - A. Patient preference if one of the noted PCI facilities is requested
 - B. Physician preference if one of the groups is requested

<u>Cardiology Group</u>	<u>PCI Hospital</u>
Novant Health Heart and Vascular	Novant Health Huntersville MC Novant Health Presbyterian MC Novant Health Matthews MC
Sanger Heart and Vascular	Atrium Health – Pineville AH Carolinas Medical Center
 - C. Patients requesting a facility other than a PCI facility will be referred to an alternate destination within the requested healthcare system

<u>Facility</u>	<u>PCI Hospital</u>
Novant Health Mint Hill Medical Center	NH Presby MC or NH Matthews MC (closer per mapping data)
Atrium Health Steele Creek	AH Pineville
Atrium Health Huntersville	AH Carolinas Medical Center
Atrium Health Mercy	AH Carolinas Medical Center
Atrium Health Mountain Island	AH Carolinas Medical Center
Atrium Health Providence	AH Pineville
Atrium Health South Park	AH Carolinas Medical Center
Atrium Health University City	AH Carolinas Medical Center
 - D. Patients not having a preference or unable to communicate their preference will be transported to the closest PCI hospital per mapping data
4. The Medical Control physician (or designee) at the destination PCI hospital of a **CODE STEMI** patient will be notified IMMEDIATELY once the categorization and the destination hospital are determined
5. Prehospital personnel will refrain from persuading a patient's decision

Note: Referring a patient to a possible substitute for the requested hospital is a suggestion. If a patient requests another hospital incorporating cardiac catheterization services other than the one referred, honor the patient's request.

Cardiac – Post ROSC Triage

1. Patients with return of spontaneous circulation (ROSC) from a medical cardiac arrest will be transported to either:
 - * Atrium Health Carolinas Medical Center
 - * Atrium Health Pineville
 - * Novant Health Huntersville Medical Center
 - * Novant Health Matthews Medical Center
 - * Novant Health Presbyterian Medical Center
2. Choice of destination emergency department will be based on the following order:
 - A. Patient/family preference
 - B. Patients without preference or unable to communicate a preference will be transported to the closest of the ROSC receiving hospitals per mapping data
3. Medical Control physician (or designee) at the destination hospital emergency department of a patient with ROSC shall be notified IMMEDIATELY once the categorization and the destination hospital are determined
4. Patients who do not achieve ROSC in the field, if transported, will be transported to the closest emergency department per mapping data

Destination Additional Considerations

- * NH Ballantyne, NH Huntersville, NH Matthews, and NH Mint Hill Medical Centers do not have hemodialysis services available
 - Patients with ESRD who may require hemodialysis during the course of treatment in the emergency department or inpatient admissions should be cautioned against transport to one of those facilities and, if requested (or closest without a preference), should be referred to NH Presbyterian Medical Center
- * AH Mercy and the AH free standing emergency departments do not have obstetrical services available
 - Patients with a likely pregnancy-related complaint (abdominal pain or vaginal bleeding in a known pregnancy) should be cautioned against transport to one of those facilities and, if requested, should be referred to another AH hospital ED
 - Patients with imminent birth or birth complication should only be transported to freestanding ED if the facility is critically closer than a hospital ED

Trauma Triage

- * Level I Trauma Center
 - Atrium Health Carolinas Medical Center
 - Atrium Health Levine Children's Hospital at CMC (Pediatric)
 - * Level II Trauma Center
 - N/A
 - * Level III Trauma Center
 - Novant Health Presbyterian Medical Center
1. Patients categorized as **Priority-1 Trauma** will be transported to the HIGHEST-LEVEL designated trauma center in Mecklenburg County
- * Patients with the following injuries or mechanisms will be considered Priority-1 Trauma
 - Head injury with a Glasgow Coma Score < 13
 - GCS < 8; lights and siren transport indicated
 - GCS 9 – 13; clinical judgment regarding use of lights and siren
 - Systolic BP < 90 mmHg
 - SBP < 110 mmHg for patients > 65-years of age
 - Respiratory Rate < 10 or > 29 or need for ventilatory support
 - Penetrating injury to the head, neck, torso or extremities proximal to the elbow or knee
 - Chest wall instability (e.g. flail chest)
 - Two or more proximal long bone fractures
 - Crushed, degloved, mangled or pulseless extremity
 - Amputation proximal to the wrist or ankle
 - Pelvic fracture(s)
 - Open or depressed skull fracture
 - Spinal injury associated with paralysis
 - Partial or full thickness (2nd or 3rd degree) burns associated with any of the following:
 - 25% body surface area
 - Involvement of face, eyes, ears, hands, feet, or perineum
 - Burns crossing major joints
 - Circumferential involvement
 - High voltage electrical etiology
 - Associated inhalational injury or major trauma
 - Traumatic arrest with signs of life in the field
 - Maternal arrest with potential for emergent C-section of viable fetus
- * *Transport **P-1** or **P-2 Trauma pediatric** patients (< 14 years) to the highest-level pediatric trauma center*

2. Patients categorized as **Priority-2 Trauma** will only be transported to a designated trauma center (category: I, II, or III) in Mecklenburg County
 - A. The decision between trauma centers will be based on patient preference
 - B. Patients not expressing a preference or unable to communicate their preference will be transported to the closest trauma center per mapping data
- * Patients with the following injuries or mechanisms will be considered **Priority-2 Trauma**
 - NO Priority-1 criteria present
 - Femur fracture associated with high energy mechanism
 - MVC, MCC, pedestrian struck, fall > 10 feet
 - Falls
 - Adults > 10 feet
 - Pediatrics* > 10 feet
 - High-risk auto crash
 - Intrusion (including roof)
 - > 12 inches into occupant site
 - > 18 inches any site
 - Ejection from automobile (partial or complete)
 - Death in same passenger compartment
 - Vehicle telemetry data consistent with high risk of injury
 - Automobile vs. pedestrian; bicyclist thrown or run over; OR impact > 20 MPH
 - Motorcycle crash > 20 MPH
 - EMS Provider's judgement that patient's injury/condition requires a trauma center
 - Examples:
 - Abdominal handlebar contusion
 - Abdominal seat belt contusion
 - Chest trauma with crepitus or subcutaneous air present
 - Rollover MVC
 - Significant head trauma or multi-trauma in patient on anticoagulation
- * The medical control physician (or designee) at the hospital receiving any patient(s) categorized as **Priority-1** or **2 Trauma** will be notified IMMEDIATELY following scene departure

Transport **P-1 or **P-2 Trauma pediatric** patients (≤ 14 years) to the highest-level pediatric trauma center*

1. Patients categorized as **Priority-3 Trauma** may be transported to any emergency department
 - A. The decision between hospitals will be based on patient preference
 - B. Patients not expressing a preference will be transported to the closest emergency department in MECKLENBURG COUNTY per mapping data
- * Patients with the following injuries or mechanisms will be Priority-3 Trauma
 - NO Priority-1 criteria present
 - NO Priority-2 criteria present
 - Head injury associated with the following:
 - Brief loss of consciousness and now awake
 - GCS > 14
 - Fall < 10 feet
 - Including hip fracture resulting from ground level fall
 - Isolated extremity injury
 - Distal extremity fractures with intact pulse
 - Penetrating injury distal to the elbow or knee
 - Minor isolated extremity injury (including minor animal bites)

Mass Casualty Incident Response

Introduction to the Incident Command System

- * The Mecklenburg EMS Agency Mass Casualty Incident Response Protocol will serve as a guide for responding to any incident involving ten or more patients
- * The purpose is to assist with efficient triage, treatment, and transportation of patients involved in a multiple casualty incident
- * It is not limited to only large-scale incidents, but for a routine incident when the number of those ill or injured exceeds the capabilities of the first arriving resources
- * The protocol aligns with the Charlotte-Mecklenburg All Hazards Plan, the North Carolina Office of EMS, the Region F Disaster Plan, and the Emergency Department Disaster Plans at Carolinas Medical Center and Novant Health Presbyterian Medical Center
- * Incident command function must be clearly established at the beginning of operations
 - The agency with primary jurisdictional authority over the incident designates the individual on the scene responsible for establishing command
 - When command is transferred, a briefing will be conducted between commanders that provides all essential information for continuing safe and effective operations
- * For incidents involving multiple jurisdictions, a single jurisdiction with multiagency involvement, or multiple jurisdictions with multiagency involvement, a unified command system will be adopted to facilitate agencies with different legal, geographic, and functional authorities and responsibilities to work together without affecting individual agency authority, responsibility, or accountability

Initial Response

- * Successful medical management of a mass casualty response relies on the crew of the first arriving MEDIC unit
 - While the first unit on the scene will establish Incident Command, the crew of the first arriving MEDIC unit shall initiate medical operations to include triage, treatment, and staging operations
 - If MEDIC is first to arrive on the scene, the Crew Chief will establish Incident Command and identify the location of the Incident Command Post to CMED
 - Incident Command will be transferred only after the arrival of a more qualified person
 - Transfer of command shall be conducted face-to-face after a briefing of event details
- * For a large-scale operation, Incident Command may establish a Medical Group or Medical Branch (EMS)
 - As such, the paramedic Crew Chief shall serve as the Medical Group Supervisor or Medical Branch Director depending on the magnitude of the incident

- * For any incident involving 3 or more priority patients (Priority-1 and/or 2), the Incident Commander will assign the appropriate level of response:
 - Level 1
 - > 101 patients
 - Response:
 - 52 First Responder personnel
 - 20 ambulances
 - 5 EMS Supervisors
 - 1 mass casualty unit
 - 2 EMS buses
 - Level 2
 - 21-100 patients
 - Response:
 - 36 First Responder personnel
 - 15 ambulances
 - 3 EMS Supervisors
 - 1 mass casualty unit
 - 2 EMS buses
 - Level 3
 - 11-21 patients
 - Response:
 - 20 First Responder personnel
 - 10 ambulances
 - 2 EMS Supervisors
 - 1 mass casualty unit
 - 1 EMS buses
 - Level 4
 - 3-10 patients
 - Response:
 - 12 First Responder personnel
 - 5 ambulances
 - 1 EMS Supervisors
- * The crew on the first arriving Medic unit shall perform scene size-up and notify CMED of a mass casualty incident in progress
- * The appropriate level of response will be communicated to CMED
- * CMED will simultaneously contact all Mecklenburg County hospitals, and upon verification that all hospitals are monitoring, announce that a mass casualty incident has occurred
- * The following information will be provided:
 - Brief description of what occurred
 - When the incident occurred
 - Where the incident occurred
 - Approximate number of patients involved and an estimate of the priorities
 - Approximate time when first patient will be transported from the scene

- * CMED will advise the facilities to review their current status and be prepared in 5 minutes to report the total number of patients, by priority, they are able to receive
- * CMED will recontact each hospital to ascertain the number of patients they can manage
 - This information will be reported to the personnel responsible for transportation

Medic Personnel Responsibilities and Incident Scene Management

- * Positions are assigned during a mass casualty incident to provide better control and communications between field operations, Incident Command, and EMS Group Supervisor
- * All Area positions may not need to be filled; the size and complexity of the incident will determine how large the management structure will be
- * Incident Command or EMS Group Supervisor will assign the most qualified personnel to handle each area function
- * Group officers should be prepared to keep Incident Command and the EMS Group Supervisor informed on progress made and the need for any specialized equipment or personnel

Triage Group Supervisor

- * Responsible for supervising or conducting the systematic sorting and prioritization of patients in accordance with the START triage system
 - At an incident involving large numbers of patients, the Triage Supervisor should request additional personnel to assist with the movement of patients from the field/triage location to the appropriate treatment location
- * Responsible for ensuring that the scene has been checked for potential victims that may have been overlooked during the initial triage phase

Treatment Group Supervisor

- * Responsible for establishing a treatment area that is large enough to handle the number of patients, emergency medical personnel providing treatment, and all required equipment
- * Responsible for managing and overseeing the actions of the Treatment Areas to ensure that appropriate basic and advanced life support is provided until patients can be evacuated to appropriate medical facilities
- * Responsible for coordinating the location of the treatment area with the Triage Supervisor
- * Area location should be at a safe distance from a hazardous materials incident site, but should be proximal to the triage area, thereby preventing victims from being carried unusually long distances
 - The treatment area should be readily accessible and should have a clearly designated ingress from triage and egress to the transportation area
 - For very large incidents, multiple triage collection points and treatment areas may be required
 - Avoid placing patients too close to vehicle exhaust or any heavy equipment that may be operating in the area

- * Treatment areas should be divided into four separate and well-identified sectors that correspond to the triage priority of the patients
- * The following outlines the patient collection areas:
 - **Red (Priority-1)**
 - Patients with life-threatening injuries or most seriously ill
 - These will be the first to be transported from the scene
 - **Yellow (Priority-2)**
 - Patients with potentially unstable / life-threatening injuries or illnesses
 - This group will be transported immediately following the Priority-1 victims
 - **Green (Priority-3)**
 - Patients with minor injuries, stable, and whose treatment or transport may be delayed (commonly referred to as "walking wounded")
 - This group will be transported following the Priority-2 victims or in mass on mass casualty transport vehicle when available
 - **Black (Deceased)**
 - Patients who are already dead or who have non-survivable fatal injuries
 - This area serves as the incident morgue
 - A law enforcement officer will be assigned to secure this area
- * If there are significant numbers of patients, the Treatment Supervisor may designate one Treatment Team Leader to oversee each of the treatment sectors (Red, Yellow, and Green)
- * When arranging the layout of the Treatment Area
 - Red (Priority-1) and Yellow (Priority-2) sectors should be proximate to each other
 - Green (Priority-3) sector should be located to the side of the Yellow sector, but of a sufficient distance to prevent those patients in the Green (Priority-3) sector from being exposed to the treatment activity
 - The Black (deceased) sector should be removed from the other treatment areas
- * Treatment Supervisor should ensure that an appropriate stock of medical equipment and supplies are available to support patient care activities in the Treatment Areas
- * Treatment Supervisor should coordinate with the Transportation Supervisor in moving patients between the Treatment Area and the Transportation Area
 - Transport Loaders will be designated to move patients from the Treatment Area to the Transport Area

Transport Group Supervisor

- * Responsible for the routing of all patients from the incident scene to area hospitals by both ground and air transportation
- * Serves as the single communications point between the scene and receiving facilities
- * Determines and maintains the number of patients (by priority) each hospital can receive
 - This task should be among the very first completed if not already accomplished by Incident Command or EMS Group Supervisor
 - A hospital representative should be assigned to the radio channel to receive notifications of ambulance departures (including number of patients on board (and priorities) to their facility)
- * Responsible for identifying an ambulance loading zone
 - This area should be large enough to accommodate multiple ambulances and should ideally provide for easy access into and out of the incident
 - Preferably, should have separate entrance and exit routes
 - Transportation Area should also be located proximal to the Treatment Areas as much as possible to prevent patients from having to be carried long distances
- * Responsible for knowing the location of any helicopter landing zone that may be established to support the incident
 - If not already assigned by Incident Command or Operations, the Transportation Supervisor may designate a Landing Zone Coordinator to establish a safe and effective landing zone in conjunction with available fire personnel on the scene
 - This function should be coordinated with Incident Command to ensure that the landing zone is in a safe area, close to the Transportation Area, and does not interfere with incident operations
 - The Landing Zone Coordinator should report to the Transportation Supervisor and assist in the movement of patients from the Treatment Area to awaiting helicopters
- * Responsible for assigning each patient to an ambulance and a corresponding destination to the ambulance crew
- * Ultimate responsibility of documenting which patients were transported to which facilities by specific EMS units (Mecklenburg County and mutual aid)
 - Tracking Coordinator recommended to assist in coordination and documentation
- * Transport Loaders will move patients from the Treatment Area to transporting vehicles
- * When ambulances crews receive their patients and are notified of the destination, they are to conduct the transport without radio contact with the receiving facility
 - All hospital notifications will be made by the Transportation Supervisor or designee
- * When units are prepared to transport, advise the receiving facility of the following:
 - The ambulance name or unit number (including helicopter EMS) transporting
 - The number of patients being transported
 - The priority of each patient
 - Any special needs (contamination, burn, OB, trauma, cardiac, pediatric)
- * The Tracking Coordinator will coordinate with the Staging Supervisor to send the appropriate number and type of resources
 - If basic life support units are standing by in the Staging Area and are required, this should be specified by the Transportation Supervisor

Staging Supervisor

- * Responsible for establishing a staging location that is proximal to the incident site, easy to locate, easily accessible, and large enough to accommodate multiple ambulances
- * It is preferable that the ambulance and fire vehicle Staging Area be either remote from each other or co-located in an area that allows ample parking for large numbers of both types of equipment
- * A simple, easy to follow route should be identified to the Transportation Area
 - This route should be directly communicated to all ambulance personnel in the Staging Area location
- * If the incident requires ambulances from out-of-county, volunteer rescue squads, or hospital ground transportation services, the Staging Manager must identify which vehicles are staffed and equipped at the basic and advanced life support level
- * Tracks the arrival and departure of all ambulances to and from the Staging Area
- * Provides Incident Command or EMS Group Supervisor and the Transportation Supervisor with the total number of ambulances in the Staging Area and is prepared to update this information
- * Ensures that all personnel remain with their vehicles
- * As ambulances arrive in the Staging Area, the Staging Supervisor will document the agency, unit number, and crew member in charge
 - All communications between the Staging Supervisor and units in the Staging Area will be through the documented crew member in charge of each unit
 - If personnel are needed to report to the scene from the Staging Area, the Staging Supervisor will ensure that the keys remain with each vehicle
- * Advise that radio communication is limited to EMS officers managing the various command functions and that scene to hospital radio communication will be handled by the Transportation Supervisor or designee
- * Do not send any units to the Transportation Area until requested to do so by the Transportation Supervisor

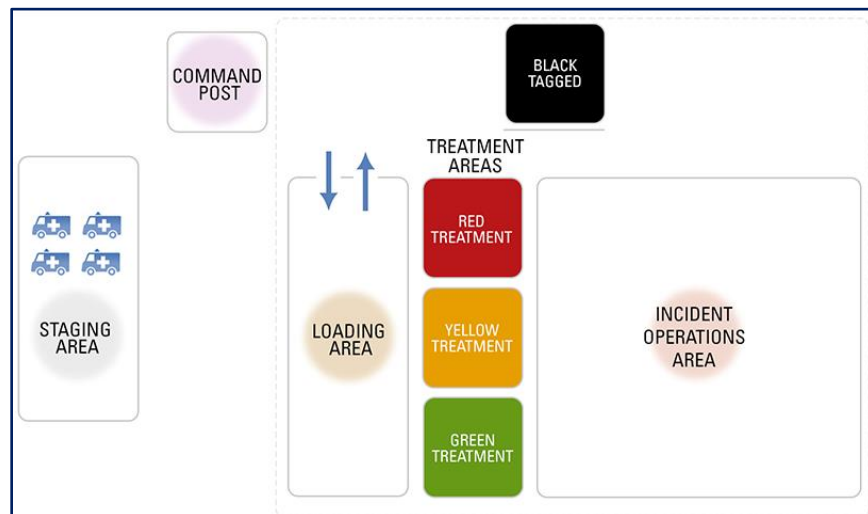

Operations Chief

- * Assists Incident or Medical Command with overall EMS scene management
- * May be assigned overall scene management and supervision, and be expected to report operational status to Incident or Medical Command in the command post
- * May also be assigned a more specific oversight function and tasked with reporting progress on that specific activity or assignment

Logistics Chief

- * Responsible for maintaining the inventory of equipment and supplies needed on the scene
- * Directs requested equipment and supplies to those areas where requested
- * Responsible for assisting with the setup of all treatment areas and distribution of equipment and supplies from the Mass Casualty Incident Response Unit
- * Coordinates with the driver/operator of the Mass Casualty Incident Response Unit for the distribution of specialized equipment from this vehicle (electrical power, light tower, portable hydraulic lighting, and inflatable shelters)
- * Coordinates with Incident or Medical Command to obtain any additional equipment and supplies that are not present on the scene

Safety Officer

- * Responsible for the safety and well-being of medical personnel and patients
- * Monitors and observes all aspects of EMS operations and advises Incident or Medical Command of procedures that reduce the risk of injury to responders

Public Information Officer

- * Reports directly to Incident Command and is responsible for expediting effective and accurate dissemination of media information related to the MEDIC response

Patient Identification

- * The START (Simple Triage and Rapid Treatment) / JumpSTART System of Triage has been adopted for use in Mecklenburg County and across the State of North Carolina
 - See START Triage algorithm
- * Primary identification of patients should be by the alpha-numeric listed on the patient triage and identification card
- * The Triage Supervisor should place this card into the attached bag and attach the bag to the wrist of all victims who are assessed by EMS crews on the scene
 - If neither wrist is available due to injury, the card may be applied to an ankle
 - Once applied on the scene, the triage and identification card should not be removed until after the patient has been positively identified at the hospital
- * Patients should not pass beyond the Transportation Supervisor without identification card applied

Initial Triage Designation

- * The triage and identification card should be removed from the bac and folded such that the designated color/priority is displayed

Color	Priority	Description
Red	Priority-1	Immediately life threatening
Yellow	Priority-2	Serious, potentially life threatening
Green	Priority-3	Stable, non-life-threatening, ambulatory
Black	Deceased	Dead, not salvageable

Secondary Triage Designation

- * Patients will be moved to the prioritized Treatment Area based on the initial triage designation
- * Upon arriving in the Treatment Area, the patient will be secondarily triaged to determine if the clinical status has changed
- * For secondary triage, complete the patient assessment and treat injuries or illnesses accordingly
- * Use the triage card to record clinical information.
- * If priority changes, remove the triage card, change to the appropriate priority, and replace the card
- * The secondary triage priority determined in the treatment area should be the priority used for transport



Patient Triage (UP-2)

1. Locate and remove all the ambulatory patients into one location away from the incident
 - A. Assign an individual (law enforcement, fire, or well-appearing patient) to keep them together until additional emergency medical resources arrive
 - B. Notify Incident Command or EMS Group Supervisor of their location
2. Ask ambulatory patients to walk to a single safe collection area & will be initially **Green**
3. Begin assessing all non-ambulatory victims at their location, as soon as safe to do so
4. **Respirations**
 - A. If respiratory rate is 30 per minute or less, proceed to *Perfusion* assessment
 - B. If respiratory rate is greater than 30 per minute (>45 or < 15 pediatrics), tag the patient **Red**
 - C. If patient is not breathing, open the patient's airway, remove any obstructions and then reassess as outlined above – If patient is still not breathing, tag the patient **Black** – If patient has spontaneous respirations tag patient **Red**
5. **Perfusion**
 - A. Palpate a radial pulse and assess capillary refill time
 - B. If radial pulse is present or capillary refill is ≤ 2 seconds, proceed to *mental status* assessment
 - C. If radial pulse is absent or capillary refill is > 2 seconds, tag the patient **Red**
6. **Mental status**
 - A. Assess the patient's ability to follow simple commands and their orientation to person, place and time
 - B. If the victim is unconscious, does not follow commands or is disoriented, tag the patient **Red**
 - C. Depending on injuries (burns, fractures, bleeding); may be necessary to tag the patient **Yellow**
 - D. If the patient follows commands and is oriented to person, place and time, and no significant injuries identified tag the patient **Green**
7. Special Considerations
8. The first assessment that produces a red tag stops further assessment
9. Only correction of life-threatening problems such as airway obstruction, chest needle decompression, or severe hemorrhage (tourniquet) should be managed during triage

Patient Movement

1. Patients initially triaged will be moved to the Treatment Area by Transport Loaders (non-ambulatory) or self (ambulatory)
 - A. Patients will be placed into the appropriate treatment sector per triage category
2. Emergency medical care will be administered in each treatment sector
3. Limited documentation will be completed on the patient triage and identification card
4. The order of transportation will proceed from **Red**, then **Yellow**, and **Green**
5. Patients will be transported from the Treatment Area to the Transportation Area by Transport Loaders
6. Transportation Supervisor will coordinate vehicle assets and loading procedures

7. Upon departure from the scene, the Transportation Supervisor or designee will provide a brief report to the designated receiving facility
8. Transporting crews will provide the report to the hospital staff on arrival

Documentation

- * During a mass casualty incident, it is difficult to obtain much of the information that is typically included as part of a routine EMS response
- * Limited pertinent documentation will be performed on the triage and identification card
- * The alpha-numeric identification on patient triage and identification card should be recorded on the patient registration form at the hospital

Termination / Recovery

- * Transportation Supervisor is responsible for handing over the master transport list to Incident Command or the EMS Group Supervisor
 - Once the completed log is received, conduct an accounting process of all casualties transported
 - Transportation Supervisor or Tracking Coordinator shall notify all facilities when the last patient is transported from the scene and that the medical components of the incident are terminated
- * Incident Command or EMS Group Supervisor, or the Safety Officer will ensure that EMS personnel have access to adequate rehabilitation as indicated (refer to Medical Monitoring protocol)
- * Once all patients are transported from the scene, the focus will be on returning the EMS system to standard operations
- * Logistics Officer will ensure that all equipment used on the scene is accounted for and returned to its appropriate vehicle
- * Arrangements should be made to provide a dedicated paramedic unit for standby as the incident moves into the investigation and cleanup phase

Additional Considerations

- * During scene size-up providers must consider HazMat, WMD, or other potential poisonings
 - Every effort should be made to approach scene from upwind, uphill direction
 - Consider potential for secondary devices
- * Triage emphasis is to ensure the best possible outcome for the greatest number of patients
- * Only life-saving procedures should be performed during initial triage
 - Airway opening
 - Antidote administration of known exposure
 - Chest needle decompression
 - Tourniquet for hemorrhage control

Medical Scene Control

First responders arrive prior to MEDIC:

1. First responders will assume the role of Medical Command and control patient care activities
2. Initial considerations are scene safety and scene evaluation
 - A. Safety issues should immediately be communicated to all responding agencies
 - B. Request additional resources and/or personnel if needed
3. All patients will be initially assessed for priority as outlined in [Initial Approach to the Scene](#) and [Universal Patient Care Protocols](#)
4. Following primary assessments and communication, treatment algorithms will be initiated
 - A. Airway management
 - B. Hemorrhage control by manual pressure or tourniquet as indicated
 - C. Bandages should not be applied until MEDIC personnel have had the opportunity to assess the injury (covering wounds for ease of re-inspection is appropriate)
 - D. Fracture immobilization
5. Cervical spine motion restriction as indicated based on mechanism of injury
 - A. A cervical collar may be applied prior to MEDIC personnel examining the spine
6. Expose the patient as indicated so that a complete assessment may be performed
7. Provide report to the responding MEDIC crew

MEDIC arrives prior to first responders:

1. The paramedic will assume the role of Medical Command and control patient care activities
2. Initial considerations are scene safety and scene evaluation
 - A. Safety issues should immediately be communicated to all responding agencies
 - B. Request additional resources or personnel if needed
3. All patients will be initially assessed for priority as outlined in [Initial Approach to the Scene](#) and [Universal Patient Care Protocols](#)
4. First responders will assume a complimentary role, assisting MEDIC personnel with equipment, supplies, medication preparation, procedures, and patient movement as directed
 - A. Responsibilities may include the following measures:
 - i. Airway equipment and supplies
 - ii. Capnometry
 - iii. Cardiac monitor
 - iv. Connecting the electrodes to the patient (4-leads or 12-leads)
 - v. Glucometer
 - vi. Hemorrhage control by manual pressure (or tourniquet if indicated)
 - vii. Preparing all components for comprehensive monitoring
 - viii. Pulse oximetry
 - ix. Spinal motion restriction and fracture immobilization
 - x. Vital signs

Transfer of Care

- * For Priority-1, 2, and 3 patients, patient care may be transferred to a physician, nurse, or paramedic at all hospitals/emergency departments
 - Transfer of care to paramedic level personnel functioning in the emergency department of the receiving facility is permitted (as approved by that facility)
 - Transfer of care to medical personnel whose training or education level is below that of a paramedic or nurse is unacceptable
 - Emergency department technicians or other ancillary departmental staff may not accept formal transfer nor sign Patient Care Reports
- * For Priority-1 or 2 trauma patients, the paramedic will provide a formal report to the physician and staff receiving the patient
 - If a physician is not immediately present, the paramedic will remain in the trauma room until a physician is in attendance for any trauma activation
- * Patients transported for any behavioral health or psychiatric condition regardless of severity or clinical nature will NOT be left unattended at the triage area
 - These patients will always be dispositioned to a treatment room or to triage nursing personnel
 - The patient is to be appropriately safeguarded and the receiving staff must be comfortable with the transfer prior to departing the room
- * When incidents involve an air medical response, the paramedic oversees patient care on the scene and will direct flight team personnel as appropriate
 - Patient care activities will then be a coordinated effort between both teams
 - Transfer of care shall occur once a formal report has been provided and all personnel agree that the transfer is appropriate
- * For nonemergency, scheduled (Priority-4) transports:
 - When conducting transports from a facility or residence, transfer of care shall occur once the patient is transported off the facility property
 - When conducting transports to a facility or residence, transfer of care shall occur once the patient report has been provided
 - This report may be to facility staff, family members, or caregivers accepting the patient

On-line Medical Control and Communications

Guidelines

- * Except for prescheduled nonemergency (Priority-4) transports, hospital notification will be provided on all patients transported and medical control requests will be made as needed
 - This includes all interfacility transfers to an emergency department
 - For interfacility transports to an emergency department, radio report must be given prior to arrival even if referring staff have provided report to receiving staff
- * Radio reports to be provided to physicians:
 - All Priority-1 patients
 - Any patient receiving pre-hospital ketamine
 - Any need for physician order or consultation regarding patient care guidance
- * Reports to be provided to nurses:
 - All Priority-2 and Priority-3 patients
- * When contacting Carolinas Medical Center for a **pediatric patient** – request a nurse or physician (depending on priority) from the Levine Children’s Hospital ED
- * Hemby CED at NHPMC has its own channel for communication
- * For incidents involving 3 or more priority patients (Priority-1 and/or 2) or 5 or more patients regardless of priority, the Crew Chief on the scene or preferably the Operations Supervisor after arrival and scene assessment, will contact the Major Treatment Attending at Carolinas Medical Center with:
 - Number of patients
 - Estimate of priority for each patient and any obvious significant injuries
 - The attending physician will assist in determining patient destinations to ensure that one facility is not overwhelmed by influx of patients
 - If the Major Attending is unavailable, the third-year emergency medicine resident on duty may be contacted
- * Past medical/surgical history and medications only pertinent to the patient's chief complaint should be reported during radio communications
- * Except under certain circumstances, reports should be as brief as possible and limited to information related to the patient’s acute illness or injury
- * The Medic unit number will be the only identifier needed (no names or employee numbers)
- * Slang terminology will NOT be tolerated, and statements should not be repeated unless requested
- * The medical control physician or nurse should initially identify themselves
 - If doubt exists as to whether a nurse or physician is taking the report and medical control orders are requested or received it is imperative to verify the individual
- * The medical control physician or designee receiving any acute cardiac or cerebrovascular accident patient should be notified IMMEDIATELY once this determination is made
- * Patients categorized as Priority-1 Medical or Trauma, the emergency department should be notified IMMEDIATELY following scene departure

Priority-1 or Priority-2 Trauma Patient Report

- * "This is unit number, we have an ETA of # minutes with an age male/female following mechanism of injury
 - From scene/facility (if interfacility transfer)
- * Airway status
- * Highest heart rate, lowest blood pressure, lowest GCS
- * Current GCS, HR, BP, RR, SpO₂, ETCO₂
- * Head / neck trauma
- * Breath sounds (equal, diminished, clear, wheezes, rales)
- * Abdomen (tenderness, soft / rigid)
- * Pelvis (stability, tenderness)
- * Extremities (deformities, neurovascular status)
- * IV access and fluid administered
- * Additional treatment administered
- * Orders requested

Priority-1 or Priority-2 Medical Patient Report

- * "This is unit number, we have an ETA of # minutes with an age male/female with presumptive diagnosis
 - From scene/facility (if interfacility transfer)
- * **Brief** HPI
 - For CODE STROKE: FAST-ED score & last time known to be normal
 - For CODE STEMI: appropriate signs & symptoms; ECG interpretation
- * Current HR, BP, RR, SpO₂
- * Mental status
- * **Pertinent** physical exam
- * Treatment administered
- * Orders requested

Priority-3 Trauma or Priority-3 Medical Patient Report

- * "This is unit number we have an ETA of # minutes with an age male/female a chief complaint of working diagnosis
- * **Brief pertinent** history and / or physical exam findings
- * Treatment administered
- * Orders requested

Additional Consideration

- * *During communication with receiving hospital, if deemed necessary to provide optimum patient care (either in the field or on arrival to the hospital) for critically ill patients, it IS acceptable to provide patient's name and DOB information to receiving physician during radio report*

Priority Bedside Report Information

Code Stroke:

- * Last time confirmed known to be normal
- * GCS
- * FAST-ED score
- * Blood pressure
- * Known past medical history
 - Known prior CVA history
- * Known medications
 - Known anticoagulants

Post Cardiac Arrest Resuscitation:

- * Witnessed vs. unwitnessed
 - Amount of time from last seen until found in arrest if unwitnessed
- * Bystander CPR
 - Yes or no
- * Initial cardiac arrest rhythm
 - AED shockable vs. non-shockable
 - Initial monitor rhythm
- * Any rhythm changes during resuscitation
- * Time of return of spontaneous circulation
- * Post-resuscitation vital signs
- * Total downtime
- * Number of defibrillations performed
- * Medications administered
- * Amount of IVF infused

High Priority Trauma

- * In addition to the information provided during radio communications of high priority trauma patients, at the bedside, report should include the time of injury
- * Providers may receive a request for a "**MIST**" report:
 - **M**echanism of injury (including time of injury)
 - **I**njuries
 - **V**ital **S**igns
 - **T**reatment provided

Nonemergency Transport

MEDIC may to transport nonemergency patients to include the following:

- * From extended care facility to physician's office
- * From hospital to hospital
- * From hospital to extended care center
- * From hospital to residence
- * From physician's office to residence
- * From residence to treatment center

Initial Evaluation

1. Upon arrival at the transferring facility, personnel will assess the patient per protocol
2. If a life-threatening (emergent) or urgent condition is apparent, the following will occur:
 - A. Discussion with referring providers of the patient's condition & any treatment or destination change, if necessary
 - B. If a BLS Unit, a BLS to ALS upgrade response should be requested
3. If no emergency condition, the patient may be transported to the prearranged facility
4. Patients with decision making capacity may refuse care or transport despite a physician's order; this must immediately be discussed with the patient's physician/care provider

Nonemergency Destination

- * If an emergency occurs enroute; the patient is to be transported to an appropriate emergency department despite original (non-ED facility) request per destination protocols
- * When transporting a patient to a prescheduled location, healthcare facility or residence, the patient may be transferred to any level of caretaker or provider at that destination
 - This may be an individual certified or trained at a level lower than EMT or paramedic, such as a certified nursing assistant or home health sitter
- * If, upon arrival at the receiving destination it is noted that the facility is not equipped to care for the patient, or the staff is refusing to accept the patient, communication shall take place between that facility and the transferring institution prior to departure
 - If resolution is not accomplished, transport the patient back to the original facility
 - If the transferring facility was a hospital, disposition may be to the emergency department (if unable to return to previous in-patient bed)
 - If the transferring facility was something other than a hospital, disposition may be made back to the patient's original room
- * When transporting patients through counties other than Mecklenburg, or states other than North Carolina, the Mecklenburg EMS Agency protocols will be followed until such time that transfer of care occurs
- * If the patient becomes unstable during transport, diversion to the closest healthcare system hospital per patient destination protocols will occur
 - If the patient has valid DNR, MOST orders and the receiving facility wishes to accept the patient in the current condition, this is acceptable

Transfer of Care

- * Upon departing the transferring facility, transfer of care shall occur once the patient is transported off the facility property
- * Upon arrival at the receiving facility, transfer of care shall occur once the patient report has been provided to facility staff, family members, or caregivers accepting the patient

Therapeutic Care during Transport

- * Nutritional infusions, such as Hyperal, amino acids, intralipids may be continued
- * Any chemotherapeutic agent currently being infused and monitored by persons other than the patient must be discontinued prior to transfer unless skilled personnel familiar with the agent and infusion accompanies the patient
 - When such personnel are not present, medications may be transported with the patient, but the infusion must be stopped
 - If it is noted by physician order or other documentation, that the chemotherapeutic infusion must be continued, there must be appropriately trained personnel attending the patient during the transport
 - If such personnel are not available, the transport must be referred to one of the hospital-based critical care transport services
 - Any violation of bag with chemotherapy agent must be considered a biohazard
 - Immediately report to the supervisor
 - Do not handle the exposed agent unless cleared to by the supervisor
- * Any therapeutic agent currently being infused and monitored by the patient, such as a continuous infusion pump, may be continued during the transfer
- * Chronic infusions or therapeutic procedures such as insulin pumps, home infusion medications, or peritoneal dialysis may be continued during transport
- * If a problem arises with the pump and/or infusion, such as pump failure or intravenous infiltration, the infusion will be discontinued by turning off the infusion device
- * For patients that are ventilator dependent, a transport ventilator may be used
 - Personnel familiar with these devices may continue the transport
 - If unfamiliar with the operation of the patient's ventilator, the transport must be referred to a crew that is familiar with the device or to one of the hospital-based critical care transport services

Special Situations

- * Medic may be asked to transport Hospice patients or patients with valid DNR, MOST orders to a residence or nursing facility
 - If patient loses vital signs while still on the property of the transferring facility:
 - Transport the patient back to their room and inform the care provider
 - If patient loses vital signs after leaving the property of the transferring facility:
 - Continue to transport the patient to their destination facility
 - Contact the Supervisor or CMED, and have them contact someone at that facility or residence to explain the circumstances

Patient Initiated Refusal of Treatment or Transport

General

- * Any patient requesting emergency medical treatment within the standard level of provision and scope of practice by the Mecklenburg EMS Agency, and/or requesting transportation to the hospital with or without treatment will be provided those services
- * **MEDIC personnel WILL NEVER refuse treatment or transport**
 - Presumptive diagnoses or other expressed medical opinions that might suggest a minor clinical condition and/or influence a patient from not being transported by EMS are inappropriate – beyond utilization of [POINT Protocol](#) discussion
 - Exception: When the health and safety of personnel is of concern
 - When such circumstances arise, the Operations Supervisor Field and Medical Control should be consulted
- * Patients may refuse the proposed treatment and/or transport provided by Medic
- * While it is encouraged that all patients be transported, individuals may refuse services if the patient has the capacity to do so
- * Capacity for medical decision-making may be defined as any patient with the following:
 - Able to make informed decisions regarding their health & healthcare
 - Able to understand the nature and severity of their presumptive process
 - Able to understand the risks of refusing care
 - Including permanent disability, debilitation, death
 - Able to understand the benefits of receiving care
 - Additional evaluation and/or diagnostic testing
 - Treatment unavailable in the field
 - Demonstrating no evidence of being under the influence of mind-altering substances including the following:
 - Clear sensorium without delusions
 - Oriented to person, place, and time
 - No new signs of incoordination
 - No new slurred speech patterns
 - NOT a threat to harm themselves or others
 - NOT suicidal
 - NOT homicidal
 - NOT medically unstable thereby impacting their ability to make informed decisions
 - Including but not limited to any process affecting decision-making:
 - Hypoglycemia
 - Hypotension
 - Hypothermia/hyperthermia
 - Hypoxia
 - Significant bradycardia or tachycardia
- * It is imperative for the provider to act in the patient's best interest in determining the decision-making capacity

Patients WITH Capacity to Refuse Treatment or Transportation

1. When an adult patient (age \geq 18-years) refuses care and other patient care or priority activities are not necessary (multiple casualty incident, system status demands), the following procedure will be followed:
 - A. An appropriate mental status examination shall be performed
 - B. The patient will be thoroughly evaluated as the patient permits
 - C. Patient evaluation will follow guidelines outlined in the patient care protocols for the patient's chief complaint and include any diagnostic test as indicated (e.g. blood glucose, 12-lead ECG, pulse oximetry)
 - D. At a minimum, the following will be performed:
 - i. Blood glucose checked on all diabetic patients with a medical complaint, or any patient with a history of altered sensorium prompting the 911-call
 - ii. Pulse oximetry checked on any patient with a respiratory complaint
 - iii. A 12-lead ECG will be obtained on any patient complaining of chest discomfort, angina equivalent symptoms, syncope, or any patient with a history of chest pain or discomfort prompting the 911-call
 - E. Pertinent historical and physical findings will be obtained and discussed with the patient
 - F. Treatment interventions and transportation will be offered/recommended
2. If the patient continues to refuse care or transport, discuss the risks of refusing
 - A. Risks must, at a minimum, include worsening condition with possible permanent disability or death
3. Communication should be such that the patient fully understands each of the risks outlined
 - A. If a language barrier exists, translators or language line resources must be used
 - B. If available, and permitted by patient, attempt to involve family members and/or friends to speak with the patient regarding their decision to be treated and/or transported
 - C. Patient should be able to reiterate the risks and benefits discussed with them
4. All patient questions will be answered
5. Reasonable scene treatment will be offered and administered if accepted by the patient
6. At a minimum, documentation will consist of the Patient Refusal Form with supplemental information included on the Patient Care Report as needed
 - A. Verification of discussion of risks and benefits of refusal with the patient
 - B. Verification of the capacity of the patient to refuse treatment/transport
7. Patient refusal information will be completed for patients refusing care
8. The patient's signature will be obtained on the Patient Care Report along with appropriate witness to the patient's refusal of treatment/transport
 - A. Witness should not be an additional member of the patient care team if another person is available to sign as witness
9. If the patient refuses to sign, the Crew Chief will indicate this and sign the report
10. Patients who refuse treatment and/or transport will be given appropriate follow-up precautions/information

Patients WITHOUT the Capacity to Refuse Treatment/Transport

1. Patients determined to NOT have adequate decision-making capacity, including suicidal threats or gestures, may refuse treatment in the field, but may not refuse transportation to the hospital
 - A. Patients WITHOUT adequate decision-making capacity will be transported to the emergency department for further evaluation/treatment
 - B. Patients WITHOUT adequate decision-making capacity will be transported to the emergency department regardless of consent to transport
 - C. Criteria related to patient's lack of decision-making capacity must be documented
2. If not on scene, request police are enroute to the scene as indicated by patient presentation
3. The patient will be thoroughly evaluated with pertinent historical and/or physical findings communicated to the patient
4. Treatment interventions will be performed as the patient permits and it is safe to do so
5. All patient questions should be answered
6. The following options are available for patients continuing to refuse care but lacking capacity to refuse care:
 - A. Contact medical control
 - B. Engage first responder's assistance
 - C. Discuss situation with police and request assistance
 - D. Request consultation with police supervisors (sergeant, captain)
 - E. Provide for consultation between medical control, police, and/or the patient
 - F. It may be appropriate for law enforcement to speak directly with medical control for a plan to be developed in the best interest of the patient
7. Transportation may only be provided by ambulance and not by a patrol car
 - A. Exception – patients with suicidal ideation, but no suicide attempt/ingestion may be transported to a behavioral health facility if no acute medical need is identified by EMS evaluation and patient/law enforcement consent to such transport
 - B. Exception – patients with known psychiatric diagnosis, requesting evaluation and/or treatment for same and no acute medical need is identified by EMS evaluation and patient/law enforcement consent to transport to a behavioral health facility
8. It is permissible to have police accompany the patient in the back of the ambulance

Special Situations – patient < 18-years of age

- * Patients < 18-years of age may not consent to or refuse emergent medical care or transportation unless emancipated
- * An emancipated minor is < 18-years of age and at least one of the following:
 - Married
 - Has become a member of the United States Armed Services
 - Has been declared emancipated by a court or other similar entity
- * Emancipated minors have the legal rights of an adult and are free of parental or legal guardian authority
 - Person must be \geq 16-years of age to receive this decree
- * Efforts should be made to obtain consent / refusal from the minor's parent/legal guardian on-scene or via phone consultation
 - Any conversation with parent/legal guardian with their consent/refusal must be documented in the PCR
 - If unable to contact parent/legal guardian, this must be documented, and patient shall be transported to the emergency department with treatment deferred
 - Exception - emergent medical care should be administered as required to prevent potential morbidity or mortality
- * Per **NC § 90-21.5 *Minor's consent sufficient for certain medical health services*** parent/legal guardian consent is NOT required if a minor patient is seeking care for:
 - Sexually transmitted disease
 - Pregnancy/potential pregnancy
 - Substance abuse
 - Emotional disturbance

Special Situations – patient with suicidal ideation

- * Any patient who has attempted or is contemplating suicide is to be considered a danger to themselves and will always be transported to the hospital (or behavioral health facility as outlined previously)

Special Situations – patient with alcohol consumption

- * A patient who has recently consumed alcohol may be considered to have the capacity to make medical decisions if that patient does not appear to be clinically intoxicated and has the capacity to understand their condition and risks as defined previously
- * A patient who has recently consumed alcohol and is in his/her home, without any medical complaints, and is declining treatment and/or transport may remain at home provided:
 - Patient is deemed to NOT be at acute risk of injury (able to ambulate)
 - Patient is deemed to NOT be at acute risk of airway compromise
 - Responsible person is willing to remain on scene and monitor patient

Additional Considerations

- * A Patient Care Report will be completed on all patients that are encountered
- * A thorough history and physical examination will be performed as permitted by the patient and pertinent positive and negative findings will be documented including discussing of risks and benefits
- * Documentation must include:
 - Statement noting the patient's decision-making capacity at the time of the encounter
 - Statement noting the patient who has consumed alcohol is not clinically intoxicated at the time of refusing treatment and/or transport
 - Statement noting the risks of refusal of treatment and/or transport were discussed with the patient
 - Statement noting the patient's understanding of the risks of refusing treatment and/or transport

Crime Scenes

- * When responders enter a questionable scene such that foul play is suspected, the following protocol should be strictly adhered to:
 - Ensure that the scene is safe to enter
 - Notify the police department if not already present or responding
 - Be careful not to touch any surroundings unless necessary
 - Do not leave any items (medical supplies/packages) at the scene
 - If anything at the scene (including the patient) is moved, advise the police
- * Limit access to essential personnel only
 - Entry and exit routes should remain the same
- * Report suspicious bystanders or occurrences to the police
- * Any suicide note should not be handled
- * If a viable patient is encountered, proceed with indicated treatment protocol
- * When treating patients who have sustained penetrating wounds and clothes need to be removed, do not cut through knife or bullet holes
- * The following situations and responses may be indicated:
 - Hangings:
 - Noose/ligature must be loosened/removed as quickly as possible to promote patient resuscitation/care
 - Leave all knots intact, including the knot that the rope is suspended from and the knot making the "noose"
 - Cut the rope in an area halfway between the noose and the suspension point and in the middle of the noose
 - Weapons:
 - Extreme caution should be used when encountering patients in possession of a weapon(s)
 - Removal of weapons from a patient should be deferred to law enforcement personnel
 - It may be most appropriate for providers to retreat to a safe location until weapon(s) have been removed
 - Weapon(s) should be removed to a safe place, far from the patient and bystanders – it is best to let the police handle this
 - Weapons should not be tampered with, opened, or unloaded
 - Sexual Assault:
 - It is important victims of sexual assault be moved quickly to a safe environment if not already present
 - It is vital the patient not shower or wash any part of their body or clothing, change clothing, douche, or use the bathroom if possible
- * Crime scenes may be such that authorized police officers may prohibit prehospital personnel from entering the scene
 - Per North Carolina State Law this is permitted
 - When such circumstances arise and the responder suspects that medical assistance may be indicated, entrance to the scene should be discussed with the officer and, if necessary, their supervisor
 - If continued resistance is met, the responsible police officer's badge number shall be recorded on the Patient Care Report before departing the scene

Medical Incident Review Process

Objectives

- ❖ The Medical Incident Review Process is designed to create a standard review algorithm that is consistent and appropriate for every incident in question
- ❖ The following are components of the process:
 - Standard algorithm for data retrieval, documentation, review, and outcome measures for each category of incident
 - Standard nomenclature that defines and characterizes the severity of an incident on initial presentation and final review
 - Incident Review Committee with defined roles and responsibilities for members
 - An outcome and remediation process
 - An appeal process for conflict resolution

Methodology

- ❖ Incident processing
 - Inquiries may be received through a multitude of sources including crewmembers, Operations Supervisors, CMED, receptionist, or website
 - Regardless of person receiving the inquiry, all information will be immediately forwarded to the on-duty Operations Supervisor (for field issues) or the on-duty Communications Supervisor (for communications issues)
- ❖ Initial Notification
 - Operations personnel receiving information from the recipient source shall review the call and notify the Operations Manager, Clinical Improvement Supervisor, or Medical Director to discuss the case
 - The Supervisor may be asked to seek additional information from any source, or the decision may be made to proceed with formal processing
 - If the decision is made to proceed with an incident review, the Clinical Improvement Supervisor or designee will notify the Medical Director, if not yet involved, to discuss the case
- ❖ Category Assignment
 - Consensus will be reached with the Medical Director to assign the presumptive category

Presumptive Category 1

- ❖ Personnel's action or failure to act was associated with potential significant clinical risk
- ❖ Examples:
 - Failure to recognize an esophageal intubation
 - Failure to recognize and treat a lethal cardiac dysrhythmia
 - Failure to recognize a potential life-threatening condition in a non-transport
 - Performing medical acts or procedures not within the scope of practice of the provider or Mecklenburg EMS Agency, or administering medications not approved by the Medical Director

Presumptive Category 2

- ❖ The personnel's action or failure to act was associated with potential moderate clinical risk
- ❖ Examples:
 - Inappropriate medication administration (administering a medication to which the patient was allergic, inappropriate dose or inappropriate route of administration)
 - Failure to recognize appropriate diagnosis and following the wrong protocol
 - Failure to bring required equipment to the patient
 - Prolonged scene time in a high priority trauma patient who required immediate and definitive in-hospital care

Presumptive Category 3

- ❖ The personnel's action or failure to act was associated with potential minimal clinical risk
- ❖ Examples:
 - Walking a patient to the ambulance
 - Failure to transport a patient to their requested facility, or coercing a patient to be transported to an alternate facility
 - Allowing patient to refuse care who lacks the capacity to refuse treatment or transport

Presumptive Category 4

- ❖ The personnel's actions were consistent with standard prehospital medical practice and are not associated with any clinical risk
 - Documentation issues
 - Interpersonal action concern

Review Processing

- ❖ Clinical Improvement or Operations personnel will initiate an Incident Review Worksheet to document that notifications and initial processing procedures are complete
- ❖ Operations should contact Clinical Improvement staff and/or appropriate first responder agency staff who will have the responsibility for obtaining all information pertinent to the case
- ❖ A Documentation Worksheet will be initiated to ensure that the review process is complete and appropriate

Presumptive Category 1

- ❖ Personnel involved are immediately placed on administrative leave with pay
- ❖ There will be no patient care activity at any level
- ❖ Barring unforeseen or unanticipated delays, the review process will take place within two (2) business days from the time the incident was reported
- ❖ The Medical Director or EMS Fellow will be present for the review

Presumptive Category 2

- ❖ Personnel involved may remain on duty and may continue all patient care activities
- ❖ Barring unforeseen or unanticipated delays, the review process will take place within three (3) business days from the time the incident was reported
- ❖ The Medical Director or EMS Fellow will be present for the review

Presumptive Category 3 & 4

- ❖ Personnel involved will remain on duty and may continue all patient care activities
- ❖ Barring unforeseen or unanticipated delays, the review process will take place within five (5) business days from the time the incident was reported
- ❖ At a minimum, the Clinical Improvement Supervisor will be present for the review

All Presumptive Categories

- ❖ Formal discussion of the incident with the personnel involved with the case, other than activities associated with obtaining facts, shall not occur prior to the Incident Review Committee meeting

Incident Review Committee

- ❖ Committee representation will be based on the presumptive category assigned to the incident and may include the Medical Director or EMS Fellow, Deputy Director of Professional Services, Deputy Director of Operations or their designees
- ❖ Depending on the nature of the incident and initial findings, other members may include representation from CMED, first responder agency involved, or education services
- ❖ Incident Review involving clinical issues will be led by the Medical Director or designee
- ❖ Incident Review involving operational issues will be led by the Deputy Director of Operations or designee
- ❖ Clinical Improvement will be responsible for setting up and coordinating the time and location for all committee meetings
- ❖ Medical Director, with Clinical Improvement & Operations, will determine committee representation
- ❖ All Presumptive Category 1 and 2 reviews will require a formal Incident Review meeting
- ❖ Incidents categorized as Presumptive 3 or 4 may only require consultation between committee members without convening a formal committee meeting
- ❖ All personnel involved will have the opportunity to describe and discuss their recollections of the event and any rationale for their performance
- ❖ Review Committee members will have the opportunity to ask any relevant questions to assist them in determining the appropriateness of the providers actions
- ❖ Once all case information is presented, the committee will discuss the case privately
- ❖ A consensus decision will be made with reference to outcome and recommendations
- ❖ Each case will be assigned a Definitive Category
- ❖ Recommendations on disciplinary measures and/or remediation will be included in the summary, along with the timeframe for completion of remediation

Definitive Category 1

- ❖ The provider's action or failure to act likely directly contributed to an adverse outcome

Definitive Category 2

- ❖ The provider's action or failure to act did not clearly contribute to an adverse outcome

Definitive Category 3

- ❖ The provider's action or failure to act had no effect on patient outcome

Definitive Category 4

- ❖ The provider's action was appropriate and consistent with prehospital medical practice

Definitive Category Subset

- ❖ S = system issue(s) identified

Remediation Process

- ❖ Depending on the Definitive Category assigned, remediation may be required
- ❖ Recommendations for remediation will be determined by the Incident Review Committee as part of the review process
- ❖ Recommendations may include any educational process, tutoring, committee or clinical activity participation, or other special project outlined
- ❖ Recommendations will also include other pertinent issues such as time frame for completion, penalties or consequences for noncompliance, any affects concerning salary, and documentation
- ❖ All final decisions for medical issues and operational issues will be made by the Medical Director and the Deputy Director of Operations, respectively

Notification

- ❖ Clinical Improvement, Medical Director, or designee will be responsible for providing incident review results, decisions, and remediation requirements as applicable, to the provider(s)
- ❖ Notifications will be made at the conclusion of the incident review and discussed with the involved personnel

Documentation

- ❖ All incident reviews will be documented
- ❖ Clinical Improvement personnel will be responsible for ensuring that all documents, including Patient Care Reports, CMED reports, supplemental reports, etc. are placed in a dedicated, secured file maintained by Clinical Improvement staff
- ❖ A specified marker will be placed in the employees' file maintained by Human Resources and in the Medical Services database to indicate that an incident review was conducted

Appeal Process

- ❖ If the provider disagrees with the findings and/or remediation recommendations from the Incident Review Committee following completion of the review process, the provider must submit their concerns in writing to the Deputy Director of Operations within 1 week of notification of the findings/remediation recommendations
- ❖ Case information, decisions, and recommendations will be forwarded to the Executive Director for further review and final decision as indicated
 - Decision may include upholding the Incident Review Committee's original decision or forwarding the case to a Medical Control Board subcommittee for further review

*This
Page
Blank*



SECTION 2

Patient Related Policies

Criteria for Death/Withholding Resuscitation (Disposition-1)

Objective

- * To define instances when resuscitative efforts may be terminated or withheld
- * To honor patient's wishes at end-of-life

Medical Care

1. CPR / ALS treatment may be withheld for the following conditions:
 - A. The patient has a valid (original, signed by the patient or guardian, and dated) **DO NOT RESUSCITATE** order
 - B. The patient has a valid **MOST Form** noting DNR order
 - C. The patient has sustained injuries incompatible with life:
 - i. Burned beyond recognition
 - ii. Decapitation
 - iii. Blunt force trauma to chest &/or abdomen and absent vital signs
 - Pulseless, apneic, no signs of life
 - iv. Massive open/penetrating trauma to head or torso with organ destruction
 - D. Obvious signs of death are present:
 - i. Body decomposition
 - ii. Dependent lividity
 - Onset occurs 1–2 hours after death
 - Peaks 6 hours after death
 - iii. Rigor mortis
 - Face and neck approximately 5 hours after death
 - Chest and arms approximately 7 – 9 hours after death
 - Entire body approximately 12 hours after death
2. If initiated by personnel on scene CPR / ALS may be terminated if:
 - A. Any of the above criteria is present
 - OR ALL** of the following
 - B. Patient > 18 years of age
 - C. Asystole on ECG following extended downtime (> 20 minutes)
 - D. Adequate CPR and/or ACLS has been performed
 - E. Airway has been successfully managed
 - F. ETCO₂ < 20
3. If any doubt exists initiate / continue resuscitative efforts
4. Resuscitation should be continued on all pediatric patients unless patient has sustained injuries noted above which are incompatible with life
 - A. For significant evidence of multi-hour downtime – contact medical control
5. Crime scenes are such that authorized police officers may declare a patient dead and prohibit prehospital personnel from entering the scene
 - A. When such circumstances arise and the paramedic suspects that medical assistance may be indicated, entrance to the scene should be discussed thoroughly with the officer and if necessary, their supervisor & record the officer's badge number on the PCR

Deceased Subjects (Disposition-2)

Objective

- * EMS will handle the disposition of deceased subjects in a uniform, professional, and timely manner
- * Maintain respect for the deceased and family

Indication

- * Disposition of patients with unsuccessful prehospital resuscitation efforts and pronounced in the field
- * Disposition of patients having injuries incompatible with life
- * Disposition of patients with obvious evidence of death prior to MEDIC arrival

Medical Care

1. Contact Medical Control for any concerns regarding pronouncing patient in the field
2. Do not remove lines or tubes unless directed to do so by Incident Command
 - A. If destination is other than county morgue lines/tube may be removed prior to transport
3. Notify appropriate law enforcement agency
4. Ensure respect for the deceased and family is maintained
5. Scene should be maintained as a potential crime scene until directed otherwise by law enforcement
6. Record patient disposition on PCR
7. Document the situation, name of Physician or Medical Examiner contacted, the agency providing transport of the deceased subject, and the destination on the PCR as applicable

Additional Considerations

- * For patients pronounced in the field, the following require notification of the Medical Examiner
 - Accidents
 - Poisonings
 - Homicides
 - Suicides
 - Violence
 - Occurring in jail , prison , correctional institution , or in LEO custody
 - Occurring under suspicious , unusual , or unnatural circumstances
 - Sudden unexpected death when in otherwise good health
 - No current primary care or specialty physician care
- * Utilize [Organ Procurement Agency Notification Policy](#) as indicated

Discontinuation of Prehospital Resuscitation (Disposition-3)

Indication

- * Criteria for discontinuation of prehospital resuscitation after delivery of adequate CPR and ALS treatment

Medical Care

1. ACLS care per appropriate protocol for medical cardiac arrest
 2. For all cases where pronouncement of death may occur and regardless of medical or trauma etiology, the following will be performed:
 - A. Assess patient for vital signs
 - B. Apply cardiac monitor (4 leads)
 - C. Assess rhythm in multiple leads
 - D. Obtain rhythm strip to be included as part of the Patient Care Report
 3. When pronouncing prior to contact with medical control **ALL** the following conditions must be met:
 - A. Age \geq 18-years
 - B. High quality CPR and appropriate airway management have been preformed
 - C. No evidence of:
 - i. Drug/toxin overdose
 - ii. Hypothermia
 - D. Rhythm appropriate medication have been administered without ROSC
 - E. Non-shockable rhythm on monitor
 - F. All EMS personnel agree that discontinuation of resuscitation is appropriate
 4. When resuscitation has been initiated; conditions / circumstances may result in terminating efforts and pronouncing an adult patient dead if the resuscitative efforts are unsuccessful
 - A. **Medical – asystole:**
 - i. Total resuscitation ALS > 20 minutes
 - ii. No return of spontaneous circulation
 - iii. Capnometry < 20 mmHg
 - B. **Medical – pulseless electrical activity:**
 - i. Total resuscitation ALS time > 20 minutes
 - ii. No return of spontaneous circulation
 - iii. Potential causes of PEA have been appropriately addressed
 - iv. Capnometry < 20 mmHg
 5. **Medical – ventricular fibrillation and pulseless ventricular tachycardia**
 - A. Continue resuscitation efforts and initiate transport of patients with persistent/refractory or recurrent ventricular fibrillation or ventricular tachycardia
- * Unless declared a crime scene by police; patients with a medical cause of cardiac arrest and in a public location should not be pronounced and left on scene but should have continued resuscitative efforts and be transported to the emergency department

6. Blunt traumatic arrest:

- A. For patient found to be pulseless, apneic, and without signs of life, may pronounce dead on scene
 - B. If patient becomes pulseless and apneic on scene:
 - i. Perform bilateral needle decompression – if blunt chest trauma
 - ii. For asystole or wide complex PEA and transport to trauma center is > 5 minutes, may pronounce dead on the scene
 - iii. For narrow complex PEA or shockable rhythm, initiate/continue resuscitative efforts and transport to the trauma center
 - C. If the patient becomes pulseless and apneic during transport:
 - i. Perform bilateral needle decompression – if blunt chest trauma
 - ii. For asystole or wide complex PEA and transport to trauma center is > 5 minutes, may pronounce dead
 - iii. For narrow complex PEA or shockable rhythm, initiate/continue resuscitative efforts and transport to the trauma center
- 7. Penetrating traumatic arrest:**
- A. If patient found to be pulseless, apneic, and without signs of life, may pronounce dead on the scene
 - B. If patient noted at any time to have palpable pulses or other signs of life continue resuscitation and transport
 - C. If patient becomes pulseless and apneic and transport time to trauma center is < 15 minutes, continue resuscitation and transport
 - D. If patient becomes pulseless and apneic and transport time to trauma center is > 15 minutes, initiate resuscitation and contact medical control
8. Contact Medical Control as needed for assistance with decision making
 9. Police personnel should always be requested if not already present on the scene
 10. If a patient loses vital signs during transport and resuscitative efforts are considered futile (valid DNR order, blunt trauma arrest, etc.), it is appropriate to discontinue resuscitation efforts and the use of emergency lights and siren
 11. Any equipment placed during the resuscitation attempt (BIAD airway, endotracheal tube, IO line, NG/OG tube) should remain in place after pronouncing the patient

Additional Considerations

- * Resuscitation and transport should be performed on all pediatric cardiac arrest patients regardless of medical or trauma etiology (unless injuries incompatible with life present)
 - Unlike adult patients, all appropriate ALS medications should be administered as indicated for both medical and trauma pediatric patients
- * Patients in cardiac arrest should not be transported by air medical transport as adequate CPR cannot be performed in the aircraft
- * Refer to [Deceased Subjects Policy](#) as indicated
- * Document all patient care and interactions with patient's family, personal physician, law enforcement, medical control or medical examiner in the PCR
- * Patients not meeting above criteria should have resuscitative efforts continued until arrival at receiving facility or discontinuation order by Medical Control

Disposition (Disposition-4)

General

- * Any patient requesting emergency medical treatment within the standard level of provision and scope of practice by the Mecklenburg EMS Agency, and/or requesting transportation to the hospital with or without treatment will be provided those services
- * **MEDIC personnel WILL NEVER refuse treatment or transport**
 - Presumptive diagnoses or other expressed medical opinions that might suggest a minor clinical condition and/or influence a patient from not being transported by EMS are forbidden – beyond utilization of [POINT Protocol](#) discussion
 - Exception to this policy:
 - When the health and safety of personnel is of concern
 - When such circumstances arise, the Operations Supervisor Field and Medical Control should be consulted
- * Patients may refuse the proposed treatment and/or transport provided by MEDIC
 - While it is encouraged that all patients be transported, individuals with the capacity to make informed medical decisions may refuse services
- * Capacity for medical decision-making may be defined as any patient with the following:
 - Able to make informed decisions regarding their health & healthcare
 - Able to understand the nature and severity of their presumptive process
 - Able to understand the risks of refusing care
 - Including permanent disability, debilitation, death
 - Able to understand the benefits of receiving care
 - Demonstrating no evidence of being under the influence of mind-altering substances including the following:
 - Clear sensorium without delusions
 - Oriented to person, place, and time
 - No new signs of incoordination
 - No new slurred speech patterns
 - NOT a threat to harm themselves or others
 - NOT suicidal
 - NOT homicidal
 - NOT medically unstable thereby impacting their ability to make informed decisions
 - Including but not limited to any process affecting decision-making:
 - Hypoglycemia
 - Hypotension
 - Hypothermia/hyperthermia
 - Hypoxia
 - Significant bradycardia or tachycardia
- * It is imperative for the provider to act in the patient's best interest in determining the decision-making capacity

Management

1. All patient encounters resulting in any component of evaluation and/or treatment must have a PCR completed
2. Any patient who refuses evaluation or treatment must be explained the risks of any refusal of treatment or transport and the potential benefits of treatment and transport
3. Communication should be such that the patient fully understands each of the risks and/or benefits outlined
 - A. If a language barrier exists, translators or language line resources must be used
 - B. If available and capable, attempt to involve family members or friends to encourage the patient to be treated and/or transported
 - i. As appropriate, consult with patient prior to involving persons not currently involved in the patient's condition
4. When an adult patient (≥ 18 years of age) refuses care and other patient care or priority activities are not necessary (multiple casualty incident, system status demands); the following procedure will be followed:
 - A. Patient will be thoroughly evaluated if the patient gives permission & allows
 - B. Evaluation will follow the standard procedure outlined in the patient care protocols
 - C. Perform any diagnostic test as indicated
 - i. Including but not limited to: blood glucose, 12-lead ECG, pulse oximetry
 - D. At a minimum, the following will be performed:
 - i. Blood glucose will be checked on all diabetic patients with a medical complaint, or any patient with a history of altered sensorium
 - ii. Pulse oximetry will be checked on any patient with a respiratory complaint
 - iii. A 12-lead ECG will be obtained on any patient complaining of chest discomfort, angina equivalent symptoms, syncope, or any patient with a history of chest pain or discomfort prompting the 911-call
 - E. Pertinent historical and/or physical findings should be obtained
 - F. Treatment interventions and transportation will always be offered
 - i. Reasonable scene treatment shall be administered if accepted by patient
 - G. Appropriate mental status examination shall be performed to determine if the patient is considered to have the current capacity for medical decision-making
 - H. All patient questions should be answered
5. At a minimum, documentation will consist of the Patient Refusal Form with supplemental information included on the PCR as indicated
 - A. This information will be completed on all patients encountered and assessed
 - B. Patient refusal information must be completed for any patient considered to be at risk for refusing care
6. The patient's signature will be obtained on the PCR
 - A. If the patient refuses to sign, the Crew Chief will indicate this and sign the report
7. Signature of person witnessing the refusal will be obtained on the PCR
8. Patients who refuse treatment and/or transport will be given appropriate instructions

Patients WITHOUT the capacity to refuse treatment and/or transport

1. Patients WITHOUT the capacity to refuse will be treated (if safe to do so) as indicated per protocol and transported to the hospital
 - A. Crew safety must be a priority
2. Patients determined to be potentially at risk for self-harm or harm to others (e.g. suicidal, homicidal) may refuse treatment in the field, but may not refuse transport
3. If not already present on the scene, ensure that the police are enroute to the scene as indicated by the situation
 - A. With the police present, the paramedic will attempt to develop a rapport with the patient and discuss plans for assessment, treatment, and transportation
4. Evaluate the patient with pertinent historical/physical findings discussed with the patient
5. Transportation may only be provided by ambulance and not by police in a patrol car
 - A. Exception: PD transport of patient to AHBHC with isolated psychiatric complaint
6. The following options are available for patients continuing to refuse care:
 - A. Contact medical control
 - B. Engage first responder's assistance
 - C. Discuss situation with police and request assistance
 - D. Request consultation with police supervisors (sergeant, captain)
 - E. Provide for consultation between medical control and police
 - F. It is permissible for police accompany the patient in the back of the ambulance

Additional Considerations

- * Contact medical control for any question as to the patient's capacity to refuse care
- * Patients less than 18-years of age may not refuse medical care or transportation unless the patient has been emancipated
- * An emancipated minor is less than 18-years of age and one of the following:
 - Married
 - Has become a member of the United States Armed Services
 - Has been declared as such by a court
 - The individual has the legal rights of an adult and is free of parental or legal guardian authority
- * A patient who has recently consumed alcohol may be considered to have capacity to make medical decisions if that patient does not appear to be clinically intoxicated and understands their condition and risks as defined above
- * Any patient who has attempted or is contemplating suicide is not considered to have decision-making capacity
 - These patients will always be transported to the hospital or behavioral health
- * It is appropriate to have law enforcement personnel speak with a physician so that a plan that is in the best interest of the patient may be developed
- * A PCR shall be completed on all patients that are encountered
 - Documentation must be completed regardless of the patient's decision to be treated and/or transported

Disposition Options

- * False call
 - No person(s) present at the location of the 911-call
 - Example:
 - Request for welfare check with no one present at the location
 - Reported MVC with no MVC present
 - Notify CMED of no person found
- * Cancellation
 - No person(s) for whom a 911-call was requested
 - Example:
 - 3rd party call for MVC; persons present on scene deny any need or request and only minimal property damage present
 - Prior to scene arrival, caller requests the response be cancelled
 - Cancellation options
 - Cancelled (caller)
 - Cancelled (CMED)
 - Cancelled (unable to locate)
 - Cancelled (other)
 - Notify CMED of cancellation
- * Patient initiated refusal
 - Providers engage in a conversation related to a person's health or potential healthcare need and the patient declines evaluation, treatment, and/or transport
 - Example:
 - Patient with medical complaint refusing EMS evaluation, treatment, and/or transport
 - Person involved in MVC with significant damage or risk of injury however refuses evaluation, treatment, and/or transport
 - Patient must meet requirements for patient initiated refusal
 - Providers complete patient refusal documentation
 - Notify CMED of patient refusal
- * Transfer of care to Medic personnel
 - Upon arrival of additional Medic providers, patient report will be provided to responding crew and further evaluation and/or treatment are transitioned to Medic
 - Includes patient who do not have the capacity to refuse treatment/transport

Additional Considerations

- * Regardless of category utilized for patient disposition, documentation in the PCR must support the disposition category and decision making

Patient Options Introduced Non-Transport (POINT)

Introduction

- * To allow providers to explain their assessment findings to the patient, and recommend against ambulance transport to an emergency department for patients without an ambulance transport need
- * EMS transports a high volume of non-emergent patients who do not benefit from the EMS to ED treatment modality
 - These patients may benefit from seeking assistance from primary care, urgent care, or may be appropriate to remain at home and perform home care after assessment

Goals

- * Direct patients to a more appropriate resource
- * Improve emergency resources availability for higher acuity patients
- * Reduce emergency department volume of patients who do not require emergency department care/resources thereby increasing capacity for those in need of emergency care
- * Reduce patient cost
- * Reduce potential exposure to COVID-19 and other disease processes

Inclusion Criteria

- * BLS level patients only
- * Age > 18-years or minor > 2-years of age accompanied by their legal guardian
- * Meets criteria for capacity to make informed medical decisions
- * Vital signs within normal thresholds for age (see below)
- * Primary impressions included:
 - Low acuity trauma
 - Examples: MVC, assault, fall, or other low acuity trauma resulting in patient suffering minor wounds or no obvious injury
 - Low acuity general illness
 - Examples: cough, nausea, vomiting/diarrhea, earache, mild intoxication with responsible party, chronic complaint with no new changes

Exclusion Criteria

- * Age \leq 2-years
- * Any spinal motion restriction precautions indicated
- * Administration of, or need for, any medication administration
- * Indication for 12-lead ECG
 - A 12-lead ECG will be obtained on any patient complaining of chest discomfort, angina equivalent symptoms, syncope, or any patient with a history of chest pain or discomfort prompting the 911-call

- * Medium or high risk for bacterial infection (Bacterial Infection Score of 1 or 2)
- * Any physician ordered transport
- * If the patient meets any of these exclusion criteria the patient may still self-select a patient initiated refusal of treatment/transport (provided with capacity to make such decision)

Management

1. EMS will assess patient complaint, vitals, and other considerations prior to determining eligibility for EMS Initiated Non Transport
 - A. PCC or EMT-TL must be involved in assessment and conversations, but do not have to be primary on the call
2. Considerations:
 - A. Co-morbidities, age (especially patients > 65-years), sex
 - B. Atypical presentations, suspicion of worsening condition
 - C. Lifestyle (high risk behaviors, drug or alcohol use)
 - D. Healthcare literacy and access to healthcare
 - E. Unsafe environment
3. If the patient self-selects to refuse EMS transport prior to EMS Initiated Non-Transport Decision, follow traditional Patient Refusal protocols
4. Based-on history and physical assessment findings, as indicated, EMS may recommend the patient does not have indication for ambulance transport to an emergency department
5. Patient may still choose to go to any healthcare facility via other transport options
 - A. POV, ride-share, etc.
6. **This conversation and decision-making should not extend past 5 minutes**
7. If the patient continues to request EMS transport to the ED, their wishes will be honored and the patient transported to the closest appropriate ED
8. If the patient agrees to non-transport, have the patient sign the "Shared Decision Making" signature fields in ePCR
 - A. Additional "Shared Decision Making" fields are available in siren to document referral to other provider (urgent care, primary care, etc.)

Vital Sign Thresholds

- * Normal mental status
- * HR appropriate for age
 - Adult < 110 bpm
 - 6-12 years: 70-120 bpm
 - 2-6 years: 80-140 bpm
- * SBP appropriate for age
 - Adult: ≥ 100 mmHg ≤ 180 mmHg
 - 6-12 years: > 90 mmHg
 - 2-6 years: > 80 mmHg
- * RR 12-22
- * SpO₂ \geq 94%

Additional Considerations

- * Providers should maintain a low threshold to transport if there are any concerns
- * Mental status examination must be performed
- * The patient will be thoroughly evaluated as the patient gives permission & permits
- * Patient evaluation will follow the standard procedures outlined in the patient care protocols for the patient's chief complaint and include any diagnostic test as indicated (e.g. blood glucose, 12-lead ECG, pulse oximetry)
 - Pertinent historical, physical, or diagnostic findings will be discussed with the patient
- * At a minimum, the following will be performed:
 - Blood glucose checked on all diabetic patients with a medical complaint, or any patient with a history of altered sensorium prompting the 911-call
 - Pulse oximetry checked on any patient with a respiratory complaint
- * Communication must be such that the patient fully understands the assessment findings and recommendations
 - If a language barrier exists, translators or language line resources must be used
- * If available, and permitted by patient, attempt to involve family members or friends to speak with the patient to be treated and/or transported
 - This does not replace the need for an approved translator or language line
- * Patients should be advised:
 - *At this time, it appears you do not require ambulance transport to an emergency department. If you develop severe symptoms, recontact 911*
- * **Medic personnel will NEVER refuse ambulance transport to a patient continuing to request such transport following POINT discussion**

Facilitated Telemedicine Encounter

Introduction

- * Telemedicine is defined as the delivery and/or facilitation of health and health-related services including medical care, provider and patient education, health information services, and self-care via video telecommunications technologies with a physician or advanced practice provider (physician assistant or nurse practitioner)
- * Goal of the field facilitated telemedicine encounter will be to use telecommunication technologies to facilitate evaluation, guide treatment, and disposition of patient in the prehospital setting and eliminate the need for transport to an emergency department
- * This protocol will assist field providers with assessment and triage of patients potentially appropriate for a facilitated telemedicine with a qualified healthcare provider
- * Though primarily intended to be utilized with patients determined by providers to be appropriate for scene treat and release following the telemedicine visit; telemedicine may be utilized with any patient encounter deemed to benefit from direct interaction on scene with the telemedicine provider
 - Patient initiated refusal with significant provider concerns
 - Potential patient care pathway recommendations

Patient Selection for Telemedicine Scene Facilitated Encounter

- * Inclusion Criteria
 - Age \geq 18-years of age or minor accompanied by their legal guardian
 - Patient deemed Priority-3
 - Meets criteria for capacity to make informed medical decisions
 - Vital signs within normal thresholds for age
 - GCS = 15
 - HR appropriate for age
 - Adult: 60 – 110 bpm
 - 6-12 years: 70-120 bpm
 - 2-5 years: 80-140 bpm
 - < 2 years: 90 – 150 bpm
 - SBP appropriate for age
 - Adult: > 100 mmHg < 180 mmHg
 - 6-12 years: > 90 mmHg
 - 2-5 years: > 80 mmHg
 - < 2 years: > 60 mmHg
 - RR appropriate for age
 - Adult: 12-20
 - 6-12 years: 16 – 20 rpm
 - 2 – 5 years: 20 – 30 rpm
 - < 2 years: 30 - 60
 - SpO₂ \geq 94%

* Exclusion criteria

- Patient deemed Priority-1 or Priority-2
- GCS < 15
- Any spinal motion restriction precautions indicated
- Medium or high risk for bacterial infection (Bacterial Infection Score of 1 or 2)
- Abnormal vital signs (adults)
- HR < 60 or > 110
- SBP < 90 or > 180
- RR > 20
- SpO₂ < 94% on room air
- Abnormal vital signs (outside of pediatric age appropriate as outlined above)
- Patient currently at a healthcare facility (MD office, urgent care) or physician ordered transport
- Patient with psychiatric complaint (unless telemedicine encounter with psychiatry is available)
- Wounds requiring suture repair or significant wound care
 - May be utilized for assistance in determining if would requires suture repair

Management

1. [Medical Initial Assessment Protocol](#) or [Trauma Initial Assessment Protocol](#)
2. Assess vital signs
3. Assess blood glucose level as indicated
4. Following the primary and secondary assessments, the Crew Chief will determine appropriate categorization
 - A. Patient requires transport to an emergency department
 - i. As per [Receiving Hospitals and Patient Destination Protocol](#)
 - B. Patient has no medical or trauma condition necessitating transport to an emergency department (or alternative destination as available) for further evaluation or treatment that cannot be provided on scene (see further below)
5. Crew Chief will discuss option of a facilitated telemedicine encounter with the patient
6. With patient agreement, Crew Chief will initiate the telemedicine encounter with the appropriate qualified healthcare provider
 - A. Atrium Health or Novant Health following standard destination triage guidelines
 - B. Patient preference first, then closest per mobile mapping data
 - C. Personnel will remain with the patient during the telemedicine encounter to assist with facilitating information to/from the provider or patient
7. Following the telemedicine encounter the patient may:
 - A. Accept telemedicine recommendations for treatment in place and release
 - B. Accept telemedicine recommendations for transport to an emergency department or alternative destination (urgent care, PCP office, etc.)
 - C. Decline telemedicine recommendations and request transport to an emergency department
8. Patients deemed appropriate for treatment and release will be provided any necessary treatment and appropriate follow-up instructions as per telemedicine recommendations

Procedure

1. Provide patient description of the encounter and intent
2. Confirm patient consent for telemedicine visit
3. Determine appropriate healthcare system for the facilitated encounter
 - A. Atrium Health
 - B. Novant Health
4. Initiate telemedicine encounter and delineate:
 - A. Patient's chief complaint
 - B. Providers primary & pertinent secondary impressions
 - C. Vital signs and pertinent physical exam findings
 - D. Reason for consultation
5. Assist healthcare system with patient registration demographics
6. Provide brief history and physical exam findings
 - A. Must include vital signs
7. Monitor telemedicine encounter to provide any assistance needed
8. Following facilitated encounter, the telemedicine consultant and MEDIC team will review care recommendations and patient disposition
9. If determined patient requires ambulance transport to an emergency department or alternative practice setting, MEDIC will transport utilizing established destination protocols
10. Any orders received from the telemedicine consultant may be followed (orders must remain within the providers scope of practice)
11. If determined patient appropriate for discharge from scene, MEDIC will affirm patient understands instructions and obtain patient signature on PCR

Communications

- * Patient communication
 - "Following our evaluation, we have determined you would benefit from a facilitated telemedicine visit with a healthcare provider with your preferred healthcare system"
 - "Which healthcare system would you like us to connect you with?"
- * Telemedicine provider communication
 - Ensure connection with telemedicine provider with Caregility telemedicine platform
 - Provide a brief provide report of the patient
 - Age
 - Chief complaint
 - Pertinent findings on scene (vital signs, physical exam)
- * Document outcome of telemedicine encounter in the PCR
 - Treatment recommendation(s)
 - Disposition recommendation(s)
 - Follow-up recommendation(s)

Additional considerations

- * Appropriate patient selection examples for telemedicine
 - Patient qualifies for POINT protocol and requests transport
 - Asymptomatic elevated blood pressure
 - Medication refill
 - Low acuity / minor general illness
 - Minor allergic reaction
 - Low acuity / minor trauma
 - Rash
 - URI symptoms with normal SpO₂
 - Wound recheck
- * Discuss with patient potential for telemedicine encounter vs. transport to an emergency department

Do Not Resuscitate and MOST Form (Disposition-5)

Introduction

- * Any patient with a completed North Carolina *Portable Do Not Resuscitate* (DNR) form shall have the form honored and CPR / ALS treatment withheld in the event of a cardiac arrest as per the patient's wishes
- * Any patient with a completed Medical Orders for Scope of Treatment (MOST) form shall have the form honored treatment limited as per the patient's wishes

Management

1. Valid **DNR** form:
 - A. **Original North Carolina DNR yellow form**
 - B. Effective & expiration dates completed (may utilize check-box for "no expiration")
 - C. Physician or Advanced Practice Provider (PA, NP) signature
2. Valid **MOST** form:
 - A. **Original North Carolina MOST bright pink form**
 - B. Effective date completed
 - C. Physician or Advanced Practice Provider (PA, NP) signature
3. A valid DNR or MOST form may be overridden (per **NC § 90-21.13**) by:
 - A. The patient
 - B. Guardian or healthcare power of attorney for the patient
 - C. Spouse
 - D. Majority of available parents/children who are \geq 18-years of age
 - E. Majority of available siblings who are \geq 18-years of age
 - F. Physician on scene
4. If requested by the patient or family that the DNR or MOST Form NOT be honored, personnel should institute appropriate medical care and contact Medical Control for further decision-making assistance as indicated
5. If requested by another person on scene that the DNR or MOST Form NOT be honored, personnel should contact Medical Control for further decision-making assistance
6. Other documents requesting withholding of CPR / ALS such as a living will may be honored with the approval of Medical Control

Additional Considerations

- * DNR orders may be written in a patient's chart or medical record
 - Orders must be complete, with date and time, and signed by attending physician
 - Telephone or verbal orders that are not signed are not acceptable without communication directly with the patient's physician
- * DNR forms from states other than North Carolina may be honored provided the form is completed, dated, and signed
- * A living will or other legal document that identifies the patient's desire to withhold CPR or other medical care may be honored with the approval of Medical Control

- * For any doubt as to the validity of the DNR or living will resuscitative efforts should be continued as till such time as:
 - Validity is determined
 - Order to withhold efforts are given by Medical Control
 - Criteria have been met in [Criteria for Death/Withholding Resuscitation Policy](#) or [Discontinuation of Prehospital Resuscitation Policy](#)

Special Situations

- * When relatives or friends of the patient request, and agree, that resuscitative measures are to be withheld and a State DNR Form or similar document (Advanced Care Directive) is not present or acceptable orders do not exist, the paramedic should attempt to establish telephone communication with the patient's personal physician or Medical Control to establish and/or confirm a DNR order
 - If this communication is established with the patient's physician and DNR orders are given, this information shall be recorded on the PCR
 - Best practice is to have another individual (preferably your partner) witness this conversation
- * In any case where doubt exists about a DNR order, the paramedic shall commence appropriate resuscitative measures until such time that attending physician contact is made or the patient is delivered to a destination hospital
 - In the event of communication failure, resuscitative measures shall be instituted
- * Any specified DNR or medical order, including the state DNR and MOST Forms, will not expire unless there is an expiration date on the document itself
- * If resuscitative measures have been initiated and a valid DNR order is presented, the resuscitation shall be terminated
 - Contact Medical Control if any questions arise
 - If the patient is successfully resuscitated before measures are ceased, the patient will be transported to the closest appropriate medical facility, withholding further resuscitative measures unless authorized to do so by appropriate sources (family members, attending physician, Medical Control)
- * A DNR order may not be honored in a situation involving pregnancy where withholding resuscitative measures would jeopardize the fetus
 - This applies to cases where the fetus would ordinarily develop into a viable birth if treatment measures were instituted (typically \geq 24 weeks of gestation)
- * DNR orders for interfacility transfers shall be written and/or signed by the attending physician

DNR Form



Effective Date: _____
 Expiration Date, if any _____

Check box if no expiration

DO NOT RESUSCITATE ORDER

Patient's full name _____

In the event of cardiac and/or pulmonary arrest of the patient, efforts at cardiopulmonary resuscitation of the patient SHOULD NOT be initiated. This order does not affect other medically indicated and comfort care.

I have documented the basis for this order and the consent required by the NC General Statute 90-21.16(b) in the patient's records.

 Signature of Attending Physician

 Printed Name of Attending Physician

 Address

 City, State, Zip

 Telephone Number (office)

 Telephone Number (emergency)

Do Not Copy Do Not Alter



NC.DHEHS.DSS.DFS.EMS Rev.102 100,000 copies of this document were printed at a cost of \$3,000.00 or \$0.03 per copy NC DEPARTMENT OF HEALTH AND HUMAN SERVICES

MOST Form

HIPAA PERMITS DISCLOSURE OF MOST TO OTHER HEALTH CARE PROFESSIONALS AS NECESSARY		
 <p>Medical Orders for Scope of Treatment (MOST)</p> <p>This is a Physician Order Sheet based on the person's medical condition and wishes. Any section not completed indicates full treatment for that section. When the need occurs, first follow these orders, then contact physician.</p>	Patient's Last Name:	Effective Date of Form: <i>Form must be reviewed at least annually.</i>
	Patient's First Name, Middle Initial:	Patient's Date of Birth:
<p>Section A Check One Box Only</p>	<p>CARDIOPULMONARY RESUSCITATION (CPR): Person has no pulse and is not breathing.</p> <p><input type="checkbox"/> Attempt Resuscitation (CPR) <input type="checkbox"/> Do Not Attempt Resuscitation (DNR/no CPR)</p> <p>When not in cardiopulmonary arrest, follow orders in B, C, and D.</p>	
<p>Section B Check One Box Only</p>	<p>MEDICAL INTERVENTIONS: Person has pulse and/or is breathing.</p> <p><input type="checkbox"/> Full Scope of Treatment: Use intubation, advanced airway interventions, mechanical ventilation, cardioversion as indicated, medical treatment, IV fluids, etc.; also provide comfort measures. Transfer to hospital if indicated.</p> <p><input type="checkbox"/> Limited Additional Interventions: Use medical treatment, IV fluids and cardiac monitoring as indicated. Do not use intubation or mechanical ventilation; also provide comfort measures. Transfer to hospital if indicated. Avoid intensive care.</p> <p><input type="checkbox"/> Comfort Measures: Keep clean, warm and dry. Use medication by any route, positioning, wound care and other measures to relieve pain and suffering. Use oxygen, suction and manual treatment of airway obstruction as needed for comfort. Do not transfer to hospital unless comfort needs cannot be met in current location.</p> <p>Other Instructions _____</p>	
<p>Section C Check One Box Only</p>	<p>ANTIBIOTICS</p> <p><input type="checkbox"/> Antibiotics if life can be prolonged.</p> <p><input type="checkbox"/> Determine use or limitation of antibiotics when infection occurs.</p> <p><input type="checkbox"/> No Antibiotics (use other measures to relieve symptoms).</p> <p>Other Instructions _____</p>	
<p>Section D Check One Box Only in Each Column</p>	<p>MEDICALLY ADMINISTERED FLUIDS AND NUTRITION: Offer oral fluids and nutrition if physically feasible.</p> <p><input type="checkbox"/> IV fluids long-term if indicated <input type="checkbox"/> Feeding tube long-term if indicated</p> <p><input type="checkbox"/> IV fluids for a defined trial period <input type="checkbox"/> Feeding tube for a defined trial period</p> <p><input type="checkbox"/> No IV fluids (provide other measures to ensure comfort) <input type="checkbox"/> No feeding tube</p> <p>Other Instructions _____</p>	
<p>Section E Check The Appropriate Box</p>	<p>DISCUSSED WITH AND AGREED TO BY:</p> <p><input type="checkbox"/> Patient</p> <p><input type="checkbox"/> Parent or guardian if patient is a minor</p> <p><input type="checkbox"/> Health care agent</p> <p><input type="checkbox"/> Legal guardian of the person</p> <p><input type="checkbox"/> Attorney-in-fact with power to make health care decisions</p> <p><input type="checkbox"/> Spouse</p> <p><input type="checkbox"/> Majority of patient's reasonably available parents and adult children</p> <p><input type="checkbox"/> Majority of patient's reasonably available adult siblings</p> <p><input type="checkbox"/> An individual with an established relationship with the patient who is acting in good faith and can reliably convey the wishes of the patient</p> <p><i>Basis for order must be documented in medical record.</i></p>	
<p>MD/DO, PA, or NP Name (Print): MD/DO, PA, or NP Signature (Required): Phone #:</p>		
<p>Signature of Parent, Parent of Minor, Guardian, Health Care Agent, Spouse, or Other Personal Representative (Signature is required and must either be on this form or on file)</p> <p>I agree that adequate information has been provided and significant thought has been given to life-prolonging measures. Treatment preferences have been expressed to the physician (MD/DO), physician assistant, or nurse practitioner. This document reflects those treatment preferences and indicates informed consent.</p> <p><i>If signed by a patient representative, preferences expressed must reflect patient's wishes as best understood by that representative. Contact information for personal representative should be provided on the back of this form.</i></p> <p>You are not required to sign this form to receive treatment.</p>		
Patient or Representative Name (print)	Patient or Representative Signature	Relationship (write "self" if patient)
<p>SEND FORM WITH PATIENT/RESIDENT WHEN TRANSFERRED OR DISCHARGED</p>		

This protocol is intended as a guideline. If it is determined that management decisions must fall outside of this guideline, contact Medical Control with clinical care-related questions or Operations Supervisor for operations-related questions. 06/27/2023

HIPAA PERMITS DISCLOSURE OF MOST TO OTHER HEALTH CARE PROFESSIONALS AS NECESSARY			
Contact Information			
Patient Representative:	Relationship:	Phone #:	
		Cell Phone #:	
Health Care Professional Preparing Form:	Preparer Title:	Preferred Phone #:	Date Prepared:
Directions for Completing Form			
Completing MOST			
<ul style="list-style-type: none"> MOST must be reviewed and prepared by a health care professional in consultation with the patient or patient representative. MOST is a medical order and must be reviewed and signed by a licensed physician (MD/DO), physician assistant, or nurse practitioner to be valid. <u>Be sure to document the basis for the order in the progress notes of the medical record.</u> Mode of communication (e.g., in person, by telephone, etc.) also should be documented. The signature of the patient or their representative is required; however, if the patient's representative is not reasonably available to sign the original form, a copy of the completed form with the signature of the patient's representative must be placed in the medical record and "on file" must be written in the appropriate signature field on the front of this form or in the review section below. Use of original form is required. <u>Be sure to send the original form with the patient.</u> MOST is part of advance care planning, which also may include a living will and health care power of attorney (HCPOA). If there is a HCPOA, living will, or other advance directive, a copy should be attached if available. MOST may suspend any conflicting directions in a patient's previously executed HCPOA, living will, or other advance directive. There is no requirement that a patient have a MOST. MOST is recognized under N.C. Gen. Stat. 90-21.17. 			
Reviewing MOST			
This MOST must be reviewed at least annually or earlier if:			
<ul style="list-style-type: none"> The patient is admitted and/or discharged from a health care facility; There is a substantial change in the patient's health status; or The patient's treatment preferences change. 			
If MOST is revised or becomes invalid, draw a line through Sections A – E and write "VOID" in large letters.			
Revocation of MOST			
This MOST may be revoked by the patient or the patient's representative.			
Review of MOST			
Review Date	Reviewer and Location of Review	MD/DO, PA, or NP Signature (Required)	Signature of Patient or Representative (Required)
			<input type="checkbox"/> No Change <input type="checkbox"/> FORM VOIDED, new form completed <input type="checkbox"/> FORM VOIDED, no new form
			<input type="checkbox"/> No Change <input type="checkbox"/> FORM VOIDED, new form completed <input type="checkbox"/> FORM VOIDED, no new form
			<input type="checkbox"/> No Change <input type="checkbox"/> FORM VOIDED, new form completed <input type="checkbox"/> FORM VOIDED, no new form
			<input type="checkbox"/> No Change <input type="checkbox"/> FORM VOIDED, new form completed <input type="checkbox"/> FORM VOIDED, no new form
			<input type="checkbox"/> No Change <input type="checkbox"/> FORM VOIDED, new form completed <input type="checkbox"/> FORM VOIDED, no new form
SEND FORM WITH PATIENT/RESIDENT WHEN TRANSFERRED OR DISCHARGED			
DO NOT ALTER THIS FORM!			
NCDHHS/DHSR/DHSR/EMS 1112 Rev. 10/07		North Carolina Department of Health and Human Services	

This protocol is intended as a guideline. If it is determined that management decisions must fall outside of this guideline, contact Medical Control with clinical care-related questions or Operations Supervisor for operations-related questions. 06/27/2023

Patient without a Protocol (Disposition-6)

Introduction

- * To ensure any person requesting EMS services will receive a professional evaluation, treatment, and transport regardless of complaint or condition
- * To ensure provision of medical care for every patient

Indication

- * Patient encounter does not fit into existing MEDIC patient care protocol

Medical Care

1. [Universal Patient Care Protocol](#)
 - A. [Medical Initial Assessment Protocol](#)
 - B. [Pediatric Initial Assessment Protocol](#)
 - C. [Trauma Initial Assessment Protocol](#)
 - D. [Pediatric Trauma Assessment Protocol](#)
2. Contact Medical Control for further management direction

Physician On-Scene (Disposition-7)

Introduction

- * To establish guidelines for medical control when a physician is present on scene
- * To ensure the patient receives the maximum benefit from EMS
- * To minimize liability of the EMS system and the on-scene physician
- * The Mecklenburg EMS Agency Medical Director is primarily responsible for overall patient care in the field
- * For individual cases, the on-line medical control physician takes partial responsibility
- * Occasionally, a physician will be present on the scene of a call
 - This may cause confusion, uneasiness, and medicolegal considerations
 - Two situations are potentially possible in this setting
 - The physician who knows the patient and has formally established a doctor-patient relationship
 - The physician who does not know the patient
 - Each case presents different physician responsibilities

Physician WITH an established physician–patient relationship

1. Includes: interfacility transfer, physician private office/clinic, urgent care center
2. MEDIC personnel will assess and manage the patient upon arrival to scene
3. MEDIC personnel may follow physician's orders as long as the crew is comfortable with treatment plan and the crew does not violate standing written protocols or violate the crew members' scope of practice
 - A. If crew is uncomfortable with any of the on-scene physician's recommendations the medical control physician should be contacted for verification of orders and/or direct physician to physician contact
 - B. If orders deviate from standard written protocols the on-scene physician must agree to accompany the patient in the ambulance to the destination facility
4. Crew will confer with patient and physician together to determine/confirm patient destination prior to departing the hospital, private office/clinic, or urgent care
 - A. If the patient requests a change to their destination decision after departing the hospital/office/clinic/urgent care, contact must be made with the facility immediately to discuss the patient's requested change of destination prior to any change in destination
 - B. If accepted by the referring staff, the original destination facility (if previously made aware of and expecting the patient), must also be notified of the patient's requested change
 - C. If patient condition changes while enroute such that it necessitates a change in destination, this also must be immediately communicated (e.g. patient develops ST-segment elevation in route necessitating diversion to a PCI capable hospital)
5. *Medic personnel will refrain from persuading a patient's destination decision*
6. Physician giving orders must sign the PCR or appropriate Physician Order Sheet

Physician WITHOUT an established physician–patient relationship

1. Scene responses
2. Physician should be given "*On-Scene Physician*" card/form
3. Physician must show proof of North Carolina Medical License Identification Card
4. Physician must sign documentation of accepting medical control of the patient
5. Crew should record the medical license number or the registration number
6. The physician must be approved by on-line medical control physician
7. The physician must accompany the patient to the hospital
8. Orders given by the on-scene physician may be followed as long as they do not violate the crew members' scope of practice
9. All orders must be signed by the physician
10. Destination decision will be based on standard destination decision protocols

Additional Considerations

- * All orders from Medical Control will supersede any on scene physician orders
- * In the event of mass casualty events, an on-scene physician may be best utilized at the scene and does not need to accompany any individual patient(s) to the hospital
- * Any on-scene physician who otherwise refuses to accompany the patient to the hospital will immediately relinquish any medical control
- * CMC PGY-1 residents riding with MEDIC may NOT assume on-scene medical control
- * CMC PGY-2, PGY-3, or higher residents riding with MEDIC, may assume on-scene medical control (5-digit license number does not need to be recorded but the physician should be listed on the PCR)
 - An on-scene resident will not decide patient destination – destination will follow standard destination decision protocol

Mecklenburg Emergency Medical Services Agency would like to thank you for your time and assistance. As a licensed Medical Doctor in the state of North Carolina, you may assume control of patient care activities. In order to do so, **ALL** the following must be satisfied:

You **MUST** show proof of current North Carolina licensure to the paramedics

You **MUST** accompany the patient to the hospital

You **MUST** carry out all orders that are not part of the paramedic's training

You **MUST** assume complete medico legal responsibility for all patient care activities until such time that care is formally transferred to another physician at the receiving hospital

During transport, the medical control physician must be notified about you assuming control. It is recommended that communication be established between the medical control physician and yourself directly. The medical control physician may supersede at any time in the prehospital setting.

Physician On-Scene (NCCEP/NC OEMS Form)



On-Scene Physician Form

This EMS service would like to thank you for your effort and assistance. Please be advised that the EMS Professionals are operating under strict protocols and guidelines established by their medical director and the State of North Carolina. As a licensed physician, you may assume medical care of the patient. In order to do so, you will need to:

1. Receive approval to assume the patient's medical care from the EMS Agencies Online Medical Control physician.
2. Show proper identification including current North Carolina Medical Board Registration/ Licensure.
3. Accompany the patient to the hospital.
4. Carry out any interventions that do not conform to the EMS Agencies Protocols. EMS personnel cannot perform any interventions or administer medications that are not included in their protocols.
5. Sign all orders on the EMS Patient Care Report.
6. Assume all medico-legal responsibility for all patient care activities until the patient's care is transferred to another physician at the destination hospital.
7. Complete the "Assumption of Medical Care" section of this form below.

Assumption of Medical Care

I, _____, MD; License #: _____
(Please Print your Name Here)

have assumed authority and responsibility for the medical care and patient management for

(Insert Patient's Name Here)

I understand that I must accompany the patient to the Emergency Department. I further understand that all EMS personnel must follow North Carolina EMS Rules and Regulations as well as local EMS System protocols.

_____, MD Date: ___/___/___ Time: ___AM/PM
(Physician Signature Here)

_____, EMS _____ Witness
(EMS Lead Crew Member Signature Here) (Witness Signature Here)

Appendix B

Organ Procurement Agency Notification (Disposition 9)

Introduction

- * When cardiopulmonary resuscitation (CPR), basic life support (BLS), and other advanced life support (ALS) interventions are withheld or discontinued on scene, EMS will report the death to the appropriate organ procurement organization servicing the county where death occurred in a timely manner
- * EMS will share information relevant to the donation process with the appropriate organ procurement organization
- * To ensure an organ procurement organization is notified of deaths pronounced in the field by EMS to:
 - Honor the decedent's registered declaration of eye and/or tissue donation
 - Preserve family's opportunity to support eye and/or tissue donation
 - Service the public health by facilitating eye and tissue donation

Management

1. Potential donors between ages of newborn – 100 years old being pronounced in the field will be referred by EMS to the appropriate organ procurement organization
2. Essential information to be provided to the organ procurement organization include:
 - A. Caller name, title, and agency contact information
 - B. Patient demographics
 - C. Last seen alive date/time or time of death
 - D. Circumstances of death (notify organ procurement agency even if ME case)
 - E. Medical interventions and medical history
 - F. Next of kin name and contact information
 - G. Who is taking custody of the decedent's body (ex: funeral home, hospital, ME)
3. Document all patient care and interactions with the patient's family, personal physician, medical examiner, law enforcement, and medical control in the EMS PCR

Additional Considerations

- * EMS SHOULD NOT discuss donation with next of kin
- * Organizations will attempt to contact appropriate family members about organ donation
- * Contact information for Mecklenburg County
 - **LifeShare of the Carolinas: (800) 932-4483**

EMS Documentation and Data Quality (Documentation-1)

Introduction

- * A Patient Care Report (PCR) will be completed for all patient encounters by MEDIC
- * A PCR will be completed for any patient not transported by MEDIC but with whom MEDIC provided any evaluation or treatment
- * The PCR shall be completed immediately following delivery of the patient to the destination facility
- * A completed PCR shall always be left with the receiving nurse or physician (provided to nurse when they sign for receiving the patient and report)
 - Exception: system resources in critical demand & need for unit to be returned to service prior to delivery of the patient care report
 - Must be communicated to the receiving nurse or physician
 - PCR must be submitted to destination hospital prior to the end of shift
- * If PCR cannot be left with receiving personnel due to extenuating circumstances, a full verbal report must be provided and PCR faxed as soon as possible

Management

- * The PCR will be completed utilizing ***SIREN PCR Suite***
- * The PCR will include (at a minimum):
 - System data and crew information
 - Dispatch information
 - Patient demographic information
 - All times related to the call
 - Care provided prior to MEDIC arrival
 - Pertinent history of present illness/injury
 - Past medical history, medications, allergies
 - Vital signs
 - Patient assessment as per specific complaint-based protocol
 - Procedures performed (timed)
 - Treatment administered including medications and patient's response (timed)
 - Patient reassessment
 - Disposition facility
 - Receiving personnel
 - Any communication with medical control
 - MD signature for any orders received beyond standing protocols
 - Disposition of any patient belongings
 - Copy of any rhythm strips, ECG's, invasive or non-invasive monitoring
 - Care providers' signatures

Documentation Pearls

- * Airway Management
 - Indication
 - BVM/iGel/Intubation
 - Number of attempts
 - Methods of confirmation
 - Vital signs pre- & post-
- * Defibrillation/cardioversion
 - Pre-shock rhythm
 - Energy delivered
 - Post-shock rhythm
 - Patient response
- * Pacing
 - Indication
 - Milliamps
 - Rate
 - Vital signs
- * Medication administration
 - Indication
 - Dosage
 - Route
 - Patient response
- * Fracture immobilization
 - Injury
 - Method of splinting
 - PMS pre-immobilization
 - PMS post-immobilization
- * Electrocardiograms (12-lead)
 - Rhythm
 - Rate
 - Nodal or bundle branch blocks
 - ST-segment or T-wave changes
- * Cardiac arrest
 - Initial rhythm
 - Treatment
 - Any rhythm changes
 - Final rhythm
 - ETCO₂
- * Patient refusal of treatment/transport
 - Confirmation of patient's decision-making capacity
 - Explanation of risks and benefits
 - Confirmation of patient's understanding of risks and benefits
- * Glucose level

Additional Considerations

- * Each medical crewmember involved in the patient's transport is responsible for content and completion of the PCR
- * Personnel should only sign the PCR after having reviewed content for completeness
- * The PCR must be electronically submitted to the PreMIS System with 24 hours of the patient encounter
- * All patients will have a dispatch signal assigned by CMED based on caller information
- * Following patient disposition, one or more retrocodes will be assigned by provider
 - The primary retrocode will be the most significant clinical condition
 - Primary impressions specifics will be documented
 - Secondary presumptive diagnoses that may have contributed to the primary retrocode may be assigned as appropriate
- * If patient experiences pulselessness at any time prior to transfer of care at the hospital, even if resuscitated, encounter should be retrocoded as: **Cardiac Arrest**
- * If patient experiences a code STEMI, encounter should be retrocoded as: **STEMI**
 - If the STEMI is noted post-ROSC, retrocode as **Cardiac Arrest**
- * If the patient experience chest pain considered consistent with acute coronary syndrome, encounter should be retrocoded as **Heart Problem**
- * **Chest Pain** retrocode should be reserved for patients complaining of chest pain in whom the evaluation determines the pain is not cardiac related (e.g. musculoskeletal chest wall pain)

Documentation of Vital Signs (Documentation-2)

Introduction

- * Every patient encounter by MEDIC will be documented
- * Vital signs will be recorded for every patient encounter
- * If patient refuses to allow vital sign measurement; this must be documented in the PCR along with statement of the patient's capacity to refuse

Medical Care

1. Initial set of vital signs to include:
 - A. Glasgow coma score
 - B. Heart rate
 - C. Blood pressure
 - D. Respiratory rate
 - E. Pulse oximetry
 - F. Temperature
2. Additional vital signs as indicated per patient complaint and/or condition
 - A. ETCO₂
 - B. Pain score
3. Reassess vital signs at a frequency dictated by the patient's condition
 - A. Minimum, vital signs should be recorded every 5 minutes on all Priority-1 patients
 - B. Minimum, vital signs should be recorded every 10 minutes on all Priority-2 patients
 - C. Minimum, vital signs should be recorded every 15 minutes on all Priority-3 patients
 - D. Minimum, vital signs should be documented at the initiation and end of the transport for scheduled non-emergency transport patients
4. Times vital signs are obtained must be documented

Additional Considerations

- * Use of automated NIBP measurements is permitted provided:
 - The first set of vital signs will include a manual blood pressure
 - The manually BP obtained should be utilized to verify the automated BP reading
 - Any discrepancy between the manual and automated must be re-verified with repeat manual blood pressure measurement
 - For continued discrepancy between manual and automated measurements it is paramount the provider considers the clinical presentation
 - Providers must always avoid relying on potentially falsely elevated automated readings if readings do not correlate with manual measurement or patient's clinical presentation
- * Patient care provider must use sound clinical judgment in patient assessment and need to verify NIBP blood pressure measurements and repeat manual blood pressure assessment as indicated

EMS Dispatch Center Time (EMS Dispatch 1)

Introduction

- * Definition
 - Time interval beginning with the time the initial 911-call is received by CMED and ending with the dispatch time of the responding MEDIC unit
- * Purpose
 - To provide the safest and most appropriate level of response to all EMS events
 - To provide timely/reliable response for all EMS events
 - To provide quality EMS service
 - To provide for continuous quality assurance

Procedure

- * All 911-calls will be managed by certified EMD personnel
- * All 911-calls will be managed according to Medical Priority Dispatch System guidelines
- * The points of accreditation delineated by the International Academy of Emergency Dispatch will be utilized for ongoing quality assurance
- * MEDIC and First Responder units will be dispatched according to sub-determinants per MPDS call taking
- * MEDIC and First Responder units will respond as dispatched (lights & siren or NO lights & siren) immediately upon dispatch
- * Dispatch priority may be changed once in route if:
 - CMED call taker determines patient condition has changed warranting an upgrade or downgrade in the response mode
 - Public safety personnel on-scene request an upgrade or downgrade based on patient condition
 - Crew chief or responding FR Captain judgement based on review of CAD notes/radio notification of patient complaint, symptoms
- * Units responding to Echo or Delta level calls will NOT be diverted to alternate calls
- * Units responding to Charlie, or non-emergent level calls may be diverted to higher priority calls if:
 - Instructed to do so by CMED personnel
 - An alternate unit is dispatched to the original lower priority call
- * Any time delays resulting in a prolonged EMS dispatch time will be documented in the PCR as an "EMS Dispatch Delay" as defined by the North Carolina College of Emergency Physicians EMS Dataset Standards Document

Additional Considerations

- A. Once dispatched, MEDIC and First Responder units will respond as dispatched (lights and siren or non-lights and siren) without question or hesitation

Children with Special Healthcare Needs (Pediatric 1)

Indication

- * Care of children with special healthcare needs
- * Unique medical condition(s)
- * Specialized medical equipment

Medical Care

1. [**Pediatric Initial Assessment Protocol**](#)
2. When appropriate MEDIC personnel may contact a child's physician for assistance with specific conditions or devices associated with the patient
 - A. Care must remain within the provider's scope of practice
3. Patient's care providers may be used as an asset in assisting with specialty patient specific equipment
4. Additional care as per the appropriate protocol

Additional Considerations

- * Any interaction with the child's physician must be clearly documented on the PCR
- * Any request outside MEDIC protocols must remain within the provider's scope of practice and be approved by Medical Control
- * Contact Medical Control for any question as to the most appropriate course of care

Infant Abandonment (Pediatric 2)

Introduction

- * The North Carolina Infant Homicide Prevention Act
 - Provides a mechanism for infants to be surrendered anonymously and taken under temporary custody by a law enforcement officer, social services worker, healthcare provider, or EMS personnel if the parent presents an infant within 7 days of birth
 - Emergency Medical Services will accept and protect infants who are presented to EMS in this manner, until custody of the child can be released to the Department of Social Services
- * Purpose
 - Protect infants that are placed into the custody of EMS under this law
 - Protect EMS systems and personnel when confronted with this issue

"A law enforcement officer, a department of social services worker, a health care provider as defined in G.S. 90-21.11 at a hospital or local or district health department, or an emergency medical technician at a fire station shall, without a court order, take into temporary custody an infant under 7 days of age that is voluntarily delivered to the individual by the infant's parent who does not express an intent to return to the infant. An individual who takes an infant into temporary custody under this subsection shall perform any act necessary to protect the physical health and well-being of the infant and shall immediately notify the department of social services. Any individual who takes an infant into temporary custody under this subsection may inquire as to the parents' identities and as to any relevant medical history, but the parent is not required to provide this information."

Medical Care

1. Assure patient safety
2. [Pediatric Assessment Protocol](#)
3. [Newly Born Protocol](#) as applicable
4. Additional care per appropriate protocol
5. Notify CMPD
6. Contact the **Mecklenburg County Department of Social Services**
 - A. **(980) 314-3577**
 - B. **(704) 336-2273**
7. Report any suspicious finding(s) to destination facility / receiving personnel
8. Transport infant to appropriate medical facility

Child Abuse Recognition & Reporting

Indications

- * Promote the recognition and reporting of child abuse to improve the safety of children
- * Protect the child from harm
- * Consider the child may be a victim of abuse
- * Collect as much information as possible

Definition

- * Child abuse is the physical, mental, sexual abuse or the negligent or maltreatment of a child under the age of 18-years by a person who is responsible for the child's welfare

Medical Care

1. Assess for characteristics of abuse
 - A. Excessive aggression
 - B. Excessive crying
 - C. Fearful behavior
 - D. Inappropriate interactions with person responsible for the child
2. Assess for physical signs of abuse
 - A. Injuries inconsistent with the history provided
 - i. Fractures in children < 2-years of age
 - B. Inconsistent history as to the mechanism of injury
 - i. Mechanisms of injury inconsistent with the child's age / development
 - C. Injuries in multiple stages of healing
 - D. Evidence of multiple prior injuries
3. Assess for signs of neglect
 - A. Absence of caregivers
 - B. Inadequate hygiene
 - C. Inappropriate clothing for current weather
 - D. Malnutrition
4. Move patient to safe location
5. Assessment and specific treatment per appropriate protocol
6. When abuse is suspected, ensure documentation of scene and clinical conditions
7. Insist on hospital transport & notify police as soon as possible
8. Report any suspicion of abuse to the receiving facility physician and nursing staff
9. Report any suspicion of abuse to Child Protective Services (CPS)

Additional Considerations

- * There is a legal requirement to report any suspicion of child abuse to **CPS**
 - **(980) 314-3577** or **Online Reporting Tool [MeckNC.gov/DSS Report](https://www.mecknc.gov/dss-report)**
 - The prehospital provider is required to report suspicion of child abuse directly to CPS as well as inform the receiving provider and record report in the PCR
- * Neglect is the most common form of abuse

Domestic Violence Recognition and Reporting

Definitions

- * Domestic abuse
 - Physical, sexual, or psychological abuse or intimidation which attempts to control another person in a current or former family, dating, or household relationship
- * Elder abuse
 - Physical, sexual, psychological abuse or negligent treatment or maltreatment of a senior citizen by another person

Medical Care

1. Ensure scene safety
2. Move patient to a safe location
 - A. Questioning or screening patients of suspected domestic abuse is best performed in a safe environment away from any family members or other significant friends
3. Protect patient from harm
4. Assess for psychological characteristics of abuse
 - A. Behavioral disorders
 - B. Excessive aggression
 - C. Excessive crying
 - D. Excessive passivity
 - E. Fearful behavior
 - F. Repeated EMS requests
 - G. Substance abuse
 - H. Violent tendencies
5. Assess for physical abuse
 - A. Defensive wounds
 - B. Injuries inconsistent with history / mechanism of injury
 - C. Multiple injuries in varying stages of recovery
 - D. Injuries during pregnancy
6. Assess for signs of neglect
 - A. Inadequate hygiene
 - B. Inappropriate clothing for weather conditions
 - C. Malnutrition
7. When abuse is suspected, ensure documentation of scene and clinical conditions
8. Insist on hospital transportation & notify police as needed
9. Report any suspicious finding(s) to destination facility / receiving personnel
10. Ensure contact with DSS for cases of suspected elder abuse or neglect
 - A. **Mecklenburg County Department of Social Services – Adult Protective Services (704) 336-2273** to report the suspicion
 - B. Child and elder abuse have mandatory reporting laws for EMS personnel in NC
 - i. Child: **NCGS § 7B-301**
 - ii. Elder abuse: **NCGS § 108A-102**

Non-Fatal Strangulation

Introduction

- * Strangulation definition: form of asphyxia caused by closing of the blood vessels and/or air passages of the neck as a result of external pressure applied
- * Symptoms:
 - Anxiety
 - Depression
 - Difficulty breathing
 - Difficulty swallowing
 - Dizziness
 - GE reflux
 - Headache
 - Insomnia
 - Lightheadedness
 - Loss of consciousness
 - Loss of sensation
 - Memory problems
 - Miscarriage
 - Neck pain
 - Sore throat
 - Suicidal Ideation
 - Tinnitus
 - Urinary incontinence
 - Vision change
 - Voice change
- * Physical exam findings
 - Altered mental status
 - Aphonia
 - Crepitus
 - Dysphagia
 - Dysphonia
 - Epistaxis
 - Facial droop
 - Focal weakness
 - Ligature contusions/burns
 - Neck abrasions
 - Neck swelling
 - Neck tenderness
 - Odynophagia
 - Paralysis
 - Petechiae
 - Respiratory distress
 - Urinary incontinence
 - Voice changes

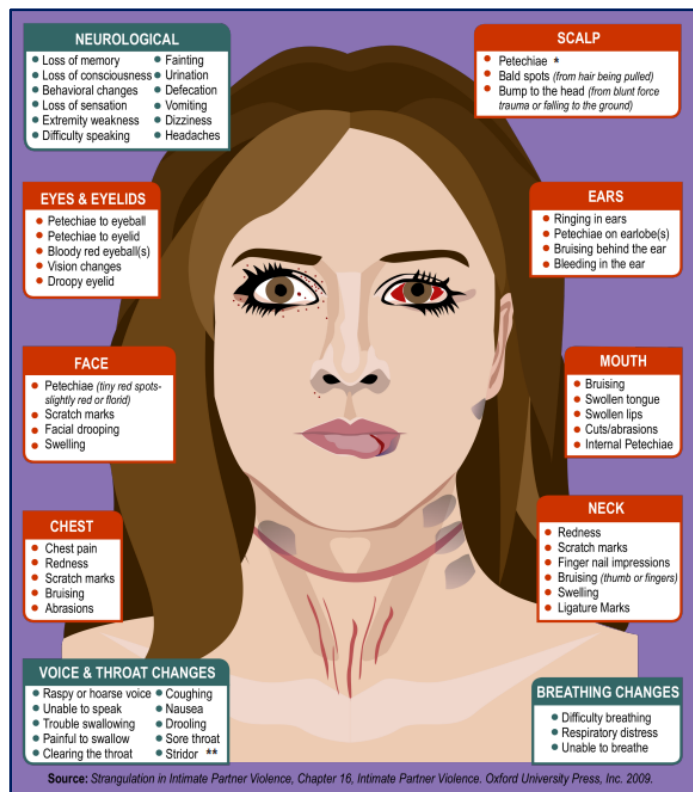

Medical Care

1. Ensure scene safety
 - A. It may be necessary to remove the patient from the surrounding area to a more protective and supportive environment
 - B. Ensure police are dispatched to the scene
2. [Trauma Initial Assessment Protocol](#) or [Pediatric Trauma Assessment Protocol](#)
3. Maintain airway
 - A. Provide assisted ventilations with bag-valve mask and 100% oxygen if breathing or ventilatory compromise is apparent
4. [Spinal Motion Restriction Protocol](#) as per patient history and presentation
5. Assess vital signs
6. Supplemental oxygen as indicated per patient condition to maintain SpO₂ = 94 – 97%
7. Control any active bleeding sites with manual direct pressure and/or pressure dressing
8. Additional treatment as per appropriate protocol
9. If a sexual assault has occurred, do not allow patient to shower or change clothes
10. Encourage transport for Forensic Nurse Evaluation at the emergency department

Additional Considerations

- * Victims of prior strangulation are 750% more likely of becoming a homicide victim
- * #2 risk factor for domestic violence homicide from the *Danger Assessment*: has the abuser ever tried to strangle (choke) the victim?
 - #1: has the abuser ever used or threatened to use a gun?
- * Pressure to occlude neck structures:
 - Jugular vein: 4 psi
 - Carotid artery: 11 psi
 - Trachea: 34 psi
- * Comparison pressures requirements:
 - Handgun trigger pull: 6 psi
 - Opening a soda can: 20 psi
 - Adult male handshake: 80-100 psi
 - Adult male max handshake: 160-180 psi
- * 50% of victims have no visible injury
 - Another 35% have injuries too minor to photograph
- * Documentation should be limited to brief history of the event objective physical findings
- * If patient refuses transport
 - Documentation will need to include more detailed account of events including
 - Type of strangulation - manual/ligature
 - Hands (one or both); arm (choke hold)
 - Ligature device used
 - Patient's complaints
 - Detail of exam findings
 - Police should provide business card for follow-up (Care Ring – Children & Family Services Center) information

Human Trafficking Victim Recognition and Reporting

Indications

- * Promote the recognition and reporting of human trafficking to improve the safety of potential victims
- * Maintain awareness that patient may be the victim of human trafficking
 - Includes: sexual exploitation, forced labor, slavery, removal of organs

Definition

- * The trade in humans, most commonly for the purpose of sexual slavery, forced labor or commercial sexual exploitation induced by force, fraud, or coercion

Human trafficking considerations

- * North Carolina is ranked as a top-10 state for human trafficking
 - Charlotte is considered a top destination as it is located at the junction of two major interstates with a direct route from shipping ports and an international airport
- * National Center for Missing & Exploited Children estimates 1 in 7 reports on endangered runaways probably involves victims of sex trafficking

Potential indicators

- * Someone else is speaking for the patient
 - Inconsistencies in story
 - History of events does not match injuries
- * Patient is not aware of his/her location, the current date, or time
- * Patient exhibits fear, anxiety, PTSD, submission, or tension
- * Patient shows signs of physical/sexual abuse, medical neglect, or torture
 - Evidence of violence/physical abuse
- * Patient is reluctant to explain his/her injury
- * Hypervigilance, paranoia, fear, anxiety, depression, submission, nervousness
- * Addiction/substance abuse; long-term antibiotic use
- * Tattoos or branding which may indicate "ownership"
- * Environmental factors
 - Hotel with doors to the outside, multiple females in a room, security designed to keep people in (locks on outsides of interior doors)
- * Pelvic, vaginal or rectal trauma
- * STDs, urinary tract trauma/infections/mutilations
- * Chronic untreated health problems

Medical Care

1. Ensure scene safety
2. [Medical Initial Assessment Protocol](#) or [Trauma Initial Assessment Protocol](#)
3. Assess vital signs
4. Move patient to a location to speak with them alone and not be overheard
5. Ask the following questions (when in private location; away from others on scene):
 - A. *Have you been forced to engage in sexual acts for money or favors?*
 - B. *Is someone holding your passport or identification documents?*
 - C. *Has anyone threatened to hurt you or your family if you leave?*
 - D. *Has anyone physically or sexually abused you?*
 - E. *Do you have a debt to someone you cannot pay off?*
 - F. *Does anyone take all or part of the money you earn?*
6. If answer is "yes" to any of the above questions, notify CMED
7. Consider location for PD response (hospital or incident location)
8. Additional treatment as per appropriate protocol
9. When human trafficking is suspected ensure documentation of scene and clinical conditions
10. Report any suspicion of human trafficking to the **National Human Trafficking Resource Center**:
 - A. Phone: **888-373-7888**
 - B. Text: **233733**
11. Report any suspicion of human trafficking to the receiving physician and nursing staff

Additional Considerations

- * Traffickers are master manipulators who convince their victims they cannot survive without them
 - Victims are sometimes allowed to roam freely without the traffickers worrying they will say anything to anyone
 - This is especially the case when traffickers have threatened to harm the victim or their family if they dare speak up
 - Some traffickers carry out violence against victims' families to convince them of their control over their lives
- * Majority of victims tend not to self-identify as victims due to the trauma they've endured
- * Additional resources
 - **Department of Homeland Security: (866) 347-2423**
 - **National Center for Missing & Exploited Children: (800) 843-5678**
 - **Federal Bureau of Investigation: (800) 225-5324**

EMS Back in Service Time (Service Metric-1)

Introduction

- * Definition
 - Time interval beginning with the time the transporting MEDIC unit arrives at the destination facility and ending with the time the unit checks back in service
 - Turn-around-time
- * All MEDIC units transporting a patient to a medical facility shall transfer the care of the patient and complete the required operational tasks to be back in service for the next potential EMS event within 30 minutes of arrival to the medical facility 90% of the time
- * Purpose:
 - Assure that each transport occurs in a timely manner
 - Assure that each transport vehicle is available for the next mission in a timely manner
 - Assure that at a minimum an interim PCR is left at the receiving medical facility
 - To provide for continuous quality assurance

Procedure

1. Upon arrival to the receiving facility, transfer of care will be performed as soon as possible
2. Personnel will provide a verbal report to receiving staff
3. A PCR will be completed at the receiving emergency department and a printed copy left with the receiving personnel
4. A PCR will be completed as soon as possible but that completion should not cause a delay in the EMS Back in Service Time
5. Any significant delay in EMS Back in Service Time will be documented in the PCR as per the North Carolina Performance Improvement request completed
6. Any time delay resulting in a prolonged EMS Back in Service Time will be documented in Patient Care Report (PCR) as an "EMS Turn-Around Delay" as required and defined in the North College of Emergency Physicians (NCCEP) EMS Dataset Standards Document

Additional Considerations

- * EMS Unit should be cleaned, disinfected, and restocked during this time interval

EMS Turn-out Time (Service Metric-2)

Introduction

- * Definition
 - Time interval beginning with the time CMED dispatches the responding unit to a specific event and ending with the time the EMS unit is enroute to the scene
- * Purpose
 - To ensure a timely/reliable response for all EMS events
 - To provide quality EMS service
 - To provide for continuous quality assurance

Procedure

- * MEDIC and First Responder units will initiate response to the scene within 60 seconds of dispatch 90% of the time
- * The points of accreditation delineated by the International Academy of Emergency Dispatch will be utilized for ongoing quality assurance
- * MEDIC and First Responder units will be dispatched according to sub-determinants per MPDS call taking
- * If any unit fails to check enroute within 2:59; the next available EMS unit will be dispatched
- * Any "turn-out" time delay will be documented in the PCR as an "EMS Response Delay" as defined by the North Carolina College of Emergency Physicians (NCCEP) EMS Dataset Standards

Poison Control Center (Toxic Environmental-1)

Indications

- * Assistance via the poison center with patients who have potential or actual poisoning
- * Purpose
 - Improve care of patients with poisonings, envenomations, or chemical/biological exposures
 - Integrate the state poison control center into response for hazardous materials

Medical Care

1. [Medical Initial Assessment Protocol](#) or [Pediatric Initial Assessment Protocol](#)
2. Assess vital signs
3. [Overdose / Toxic Ingestion Protocol](#)
4. If no immediate live threat or transport need identified crew may contact North Carolina Poison Control (State Poison Control Center)
 - A. **(800) 222-1222**
5. Poison Specialist may be utilized as a resource for treatment and/or transport recommendations
6. Contact Medical Control for direction as necessary
7. Additional care as per indicated protocol

Additional Considerations

- * Information for Poison Center Specialist
 - Name & age of patient
 - Ingestion or exposure agent
 - Time of ingestion or exposure
 - Amount of ingestion or exposure
 - Signs and symptoms present
 - Previous treatment provided
- * Maintain high index of suspicion that more than one agent may be involved in intentional overdoses

Air Transportation (Transport-1)

General

- * Air transportation should be utilized whenever patient care can be improved by decreasing transport time or by providing advanced care not available from ground EMS
- * The flight service at Carolinas Medical Center (MedCenter Air) has 4 rotor wing aircraft
 - Airbus EC-135 type helicopters
 - Crew configuration consists of RN/RN, RN/RRT, or RN/Paramedic
 - Helicopters are in Concord, NC, Hickory, NC, Wadesboro, NC and Rock Hill, SC
 - If closest MCA aircraft is not readily available to respond, MCA Dispatch will arrange for the next closest available aircraft to respond (may be a non-MCA aircraft)
- * Flight service at Novant Health Presbyterian Medical Center (Novant Medflight) has 1 rotor wing aircraft located in Salisbury, NC
 - Airbus EC-135 type helicopter

Considerations for Air Medical Transport

- * Unstable Priority-1 patient with potential prolonged transport time (> 30 minutes)
- * Potential prolonged extrication time (> 20 minutes) and potential for significant injuries
- * Any patient whose mechanism of injury or primary assessment imparts the potential for sustaining multi-system organ damage such that early operative intervention may be life-saving, or whose condition has the potential for rapid deterioration as manifested by unsecured airway or unstable vital signs
- * Multiple casualty incident, only if Priority-1 and/or 2 patients are triaged
- * Time dependent medical conditions (e.g. STEMI, LVO stroke) with prolonged/delayed ground transport
- * Any patient where the location, time of day, traffic conditions, etc. may cause a delay in transport time from the scene to the hospital

Personnel Requirements for Activation

- * Any first responder physically present on the scene of an accident or injury, and after an initial patient assessment may request the helicopter if criteria are met as stated above
- * Any member of the responding MEDIC crew, enroute to the scene or after arrival
- * The Medical Director, EMS Fellow, Operations Supervisor, or administrative staff

Activation Procedure

1. After determining a helicopter is needed, notify CMED
2. CMED will contact MedCenter Air
 - A. The flight service will be notified, along with the appropriate fire department
 - B. MedCenter Air will contact other agencies as indicated, if no MCA asset available
 - C. No other information is necessary at that time
3. MEDIC crew will be notified as to the status of the helicopter
 - A. Available and responding
 - B. Available in ____ time
 - C. Unavailable due to weather (or other issue)
4. Continue to provide patient care until such time that the helicopter arrives
5. Landing zone designation, preparation, and notification is the responsibility of the responding fire department
 - A. If patient care activities are stable and time permits, evaluating the landing zone yourself is advisable
 - B. If the designated landing zone appears to be a dangerous threat to anyone on the ground or the flight team, express those concerns to the fire incident commander

Personnel Requirements for Deactivation

- * Medic Crew Chief after patient evaluation
- * Operations Supervisor or administrative staff personnel at any time
- * The Medical Director or EMS Fellow at any time

Landing Zone Requirement

- * All landing zones should be on a solid and flat surface, clear of potentially loose debris, and located approximately 200 yards from the scene of the accident
- * There should be no obstacles or obstructions within the zone, such as trees, telephone/power poles, light poles, vehicles, landing zone personnel, etc.
- * Minimum dimensions daytime and nighttime:
100-foot x 100-foot area

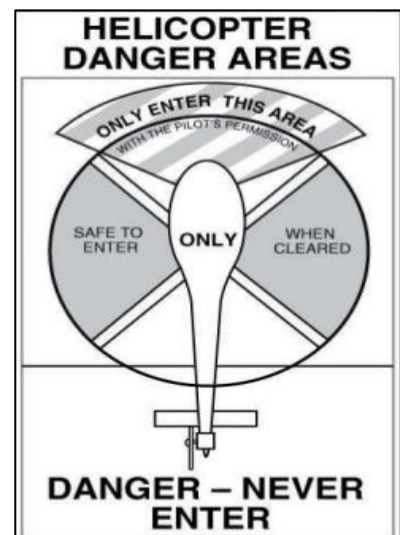
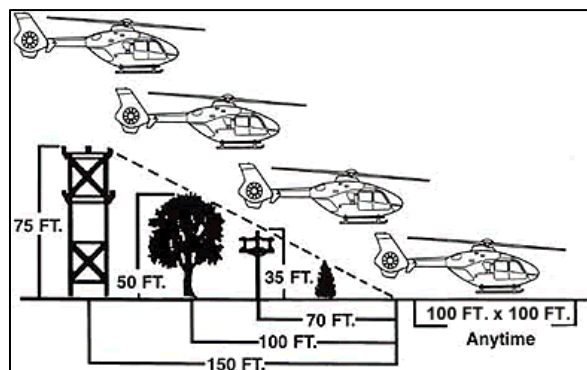

Patient Preparation

- * The patient should be prepared as usual
- * The patient should have at least one intravenous line initiated prior to departure
- * The flight team will need some patient information before arrival
 - Weight
 - Airway status
 - Obvious injuries
- * Upon arrival, the flight team will approach the scene (if safe to do so) or ambulance and request a patient report or begin their assessment
- * Prehospital personnel should never approach the helicopter without supervision or approval from the helicopter pilot
- * Both crews (MEDIC and flight) should work as a team to maximize patient care
- * If the patient has not been prepared for transport by the time the flight team arrives, the paramedic may wish to have the flight personnel assist with this activity
- * If the patient is prepared for transport and the helicopter has not landed, the paramedic may choose to transport by ground and cancel the helicopter
- * The flight team has the authority to use paralytics for intubation purposes
- * When airway issues arise, and airway management is difficult, it may prove beneficial to wait a reasonably brief time until the flight team arrives to attempt intubation using drug assisted intubation
 - This may be especially important for patients with suspected head trauma
 - If such patients are already loaded into the ambulance and ready for departure, it is acceptable to have the flight team accompany MEDIC personnel and the patient in the ambulance for ground transport

Additional Considerations

- * Cardiac arrest, from medical or traumatic conditions, is a contraindication for air ambulance activation as effective CPR cannot be performed in the helicopter during transport

Safe Transport of Pediatric Patients (Transport-2)

Indications

- * All occupants being transported must be properly restrained
- * Children must be restrained in an appropriately sized infant or child restraint seat
- * Ensure pediatric trauma patients in spinal protocol are properly secured to stretcher
- * Child restraint seats for air medical transport must be FAA approved
- * Ensure child restraint seat is properly secured to vehicle mounting site

Management

1. NEVER allow parents / caregivers to attempt to hold the patient during transport
2. Patients < 40 pounds must be restrained with an approved child restraint device secured appropriately to the stretcher or captain's chair

Additional Considerations

- * Secure all monitoring devices and other equipment
- * Transport adults and children who are not patients, properly restrained, in an alternate passenger vehicle, whenever possible



SECTION 3

Clinical Patient Care Protocols

GLAZE

Dedicated to Paramedic Nash Glaze (1962-1999)

Introduction

- * All protocols are based on standard medical care under emergent, field conditions
- * This protocol is to remind each of us the patients we respond to and care for are human beings, each having their own unique set of morals, values, and inspirations
- * When faced with difficult patients or situations, it is imperative that the prehospital provider at all levels demonstrate professionalism, tolerance, and most of all, respect for others
- * Patients come from all walks of life, each with their own set of circumstances and backgrounds
- * There is no place for judgmental attitudes or beliefs

When Entering a Home

- * Refrain from comments concerning lifestyle, surroundings, or domestic quality
- * Concentrate on the patient and their clinical situation; that is why you are there
- * While you are a public servant, you are also a guest

When Meeting a Patient

- * There is always an emergent complaint until proven otherwise
- * Remember compassion and do not lose your perspective
- * Your attitude and behavior reflect the profession, the Agency, and you as a person

When Interacting with Colleagues

- * Be considerate and respect other professions and work together to provide the best possible care for the patient in need
- * Each member plays a specific and significant role
- * Strive to build a prehospital care system that you and your community are proud of

When Providing Care

- * Not all patients require intensive therapeutic interventions, medication administration, or invasive procedures
- * The vast majority only require your attention, consideration, and concern for their health
- * The following protocols and standing orders coupled with the qualities of respect, honesty, compassion, and integrity will guide each prehospital provider to deliver quality medical care inherent to the Mecklenburg EMS Agency

... Nash Glaze exemplified each of these qualities

Initial Approach to the Scene

1. Following the dispatch to a call, prior to arrival, the MEDIC crew should organize their approach upon arrival
2. It should be predetermined which crew member will perform the primary assessment and which will perform other duties
3. Enroute to scene, crew should consider differential diagnosis based on dispatch chief complaint and pertinent CAD notes
4. Depending on the nature of the incident, equipment and supplies will be carried to the patient
 - A. Medical incidents:
 - i. Airway supplies and oxygen
 - ii. BLS/ALS equipment per crew configuration
 - iii. Cardiac monitor/defibrillator
 - iv. Medications
 - v. Stretcher
 - B. Trauma incidents:
 - i. Airway supplies and oxygen
 - ii. BLS/ALS equipment per crew configuration
 - iii. Cardiac monitor/defibrillator
 - iv. Medications
 - v. Stretcher
5. When approaching the scene, each crew member should ensure safety for themselves (following OSHA policies and procedures)
6. An initial scene evaluation is vital to request the necessary personnel or resources required to properly manage the incident
7. Once safety and resources are verified, the patient is evaluated
8. If more than one patient is involved, a rapid triage assessment must be performed
 - A. It is a judgment as to which patient to evaluate first; patients appearing critical, either by mechanism of injury or external appearance, should take precedence
 - B. Regardless of patient number, an organized approach for a primary assessment should be consistent
9. When initially meeting any patient, the provider should always introduce themselves and provide reassurance
 - A. This is important as it lets the patient know that you are a trained individual (not a bystander) who is experienced in dealing with these types of incidents
10. Following the introduction, the patient's chief complaint should be elicited
11. Patient evaluation should always be performed in a controlled environment conducive to privacy and protection
 - A. When patients are found outside, particularly pediatrics, they should be relocated and evaluated inside the ambulance if possible

Universal Patient Care Protocol (UP-1)

Objective

- * To establish the basic assessment for all patient contacts

Management

1. Ensure scene safety
2. Ensure proper personal protection equipment (PPE) following universal precautions
3. Ensure all appropriate equipment is brought to the patient
4. Obtain SAMPLE information
 - A. Signs/Symptoms
 - B. Allergies
 - C. Medications
 - D. Past Medical History
 - E. Last oral intake
 - F. Events leading to illness/injury
5. Assess per appropriate protocol
 - A. [Medical Initial Assessment Protocol](#)
 - B. [Trauma Initial Assessment Protocol](#)
 - C. [Pediatric Initial Assessment Protocol](#)
 - D. [Pediatric Trauma Assessment Protocol](#)
6. Assess mental status
7. Assess vital signs (frequency will depend on patient condition)
 - A. Glasgow Coma Score
 - B. Heart rate
 - C. Blood pressure
 - D. Respiratory rate
 - E. Pulse oximetry
 - F. Temperature
 - G. Trauma score as indicated
 - H. 4-lead ECG as indicated based on patient's presentation
 - I. 12-lead ECG as indicated based on patient's presentation
8. Further care as per appropriate protocol as per patient history / presentation
9. For any doubt as to appropriate protocol contact Medical Control
10. For any questions regarding patient care contact Medical Control

Additional Considerations

- * Any patient contact must have a completed patient care report (PCR)

Medical Initial Assessment

Airway

1. Assess airway patency
 - A. Ask all patients: "How is your breathing?"
 - i. Answer to the question (regardless of answer) notes open, patent airway
2. Open airway using standard maneuvers (head tilt/chin lift or jaw thrust) as indicated
3. Insert oral-pharyngeal airway or nasal-pharyngeal airway as indicated
4. Suction as needed to maintain open patency
5. Assess patient's ability to protect airway per [Airway Protocols](#)

Breathing

1. Assess respiratory effort and rate
2. Assess breath sounds
 - A. Auscultate left & right
 - B. Auscultate anterior & posterior
3. Assess pulse oximetry
4. Administer supplemental oxygen as indicated (nasal cannula, face-mask, BVM) based on respiratory assessment, SpO₂, and patient's clinical status

Circulation

1. Assess presence and quality of pulses
 - A. Palpate radial, femoral, or carotid pulse (in order)
2. Assess skin color and level of consciousness
3. Obtain baseline vital signs and initiate continuous ECG monitoring as indicated
4. Assess need for intravenous (or intraosseous) access and IVF administration

Disability

1. Assess neurological status
 - A. Assess whether alert; responds to voice; response to pain; unresponsive
 - B. Assess GCS & if any focal neurological deficits

Additional Considerations

- * Obtain appropriate history from patient (and/or referring facility if interfacility transfer)
- * Perform focused physical exam based on patient's history and presentation
- * Additional care per appropriate patient care protocol
- * Reassess patient throughout transport and adjust care as indicated by patient's response
- * At any point there is a change in the patient's condition restart reassessment

Trauma Initial Assessment

Airway

1. Assess airway patency
 - A. Ask all patients: "How is your breathing?"
 - i. Answer to the question (regardless of answer) notes open, patent airway
2. Open airway using standard maneuvers (jaw thrust) maintaining c-spine stabilization
3. Insert oral-pharyngeal airway or nasal-pharyngeal airway as indicated
4. Suction as needed to maintain open airway
5. Assess patient's ability to protect airway per [Airway Protocols](#)

Breathing

1. Assess respiratory effort and rate
2. Assess breath sounds
 - A. Auscultate left & right / anterior & posterior
3. Assess pulse oximetry
4. Administer supplemental oxygen as indicated (nasal cannula, face-mask, BVM) based on respiratory assessment, SpO₂, and patient's clinical status
5. BIAD as per [Airway BIAD Protocol](#) or intubate as condition indicates per [Intubation Protocol](#)

Circulation

1. Control obvious hemorrhage with direct pressure or MEDIC approved tourniquet
2. Obtain baseline vital signs and initiate continuous ECG monitoring
3. Assess presence and quality of pulses
 - A. Radial pulse = SBP \geq 80 mmHg
 - B. Femoral pulse = SBP \geq 70 mmHg
 - C. Carotid pulse = SBP \geq 60 mmHg
4. Assess skin color, distal capillary refill
5. Place large bore PIV(s) (16–18 gauge) or IO and assess need for IVF administration

Disability

1. Assess neurological status
 - A. Assess whether alert; responds to voice; response to pain; unresponsive
 - B. Assess GCS & if any focal neurological deficits
2. Institute spinal motion restriction as indicated by mechanism of injury and physical exam

Exposure

1. Remove appropriate amount of clothing to allow adequate inspection of patient
2. Protect patient from hypothermia

Secondary Survey

1. General
 - A. Abrasions
 - B. Burns
 - C. Contusions
 - D. Lacerations
2. Penetrating injuries
 - A. Head and face
 - B. Fractures
 - C. Lacerations
 - D. Otorrhea/rhinorrhea
 - E. Pupillary exam
 - F. Penetrating injuries
 - G. Swelling
 - H. Tenderness
3. Neck
 - A. Bony tenderness
 - B. Crepitus
 - C. JVD
 - D. Tracheal deviation
4. Chest
 - A. Breath sounds
 - B. Crepitus/emphysema
 - C. Penetrating injuries
 - D. Tenderness
5. Back
 - A. Bony deformity
 - B. Bony tenderness
 - C. Penetrating injuries
 - D. Swelling
6. Abdomen
 - A. Distension
 - B. Penetrating injuries
 - C. Seat belt contusions
 - D. Tenderness
7. Pelvis
 - A. Blood at urethral meatus
 - B. Bony tenderness
 - C. Bony instability
 - D. Crepitus
 - E. Penetrating injuries
 - F. Vaginal bleeding

8. Extremities
 - A. Bony deformities
 - B. Bony tenderness
 - C. Distal pulses
 - D. Motor/sensory exam
 - E. Penetrating injuries
9. Neurological
 - A. Glasgow coma score
 - B. Focal deficits (motor & sensory)

Additional Considerations

- * Time of injury
- * Mechanism of injury
- * MVC:
 - Ejection/roll-over
 - Impact location
 - Intrusion into the passenger compartment
 - Location in vehicle
 - Restraint device use
 - Speed of vehicle
- * Pedestrian / bicyclist struck
 - Helmet use
 - Speed of vehicle
- * Stabilizing treatment performed
- * IVF administration
- * Medications
 - Dose
 - Time administered

Pediatric Initial Assessment

Airway

1. Assess airway patency
2. Open airway using standard maneuvers (head tilt/chin lift, jaw thrust)
3. Insert oral-pharyngeal airway or nasal-pharyngeal airway as indicated
4. Suction as needed to maintain open airway
5. Assess patient's ability to protect airway per [Airway: Pediatric Protocol](#)

Breathing

1. Assess respiratory effort and rate
2. Assess breath sounds
3. Assess pulse oximetry
4. Administer supplemental oxygen as indicated (nasal cannula, face-mask, blow-by, BVM) based on respiratory assessment, SpO₂, and clinical status
5. BVM or BIAD per [Airway: BIAD Protocol](#) as indicated

Circulation

1. Assess presence, quality of pulses, and capillary refill
2. Assess skin color and level of consciousness
3. Obtain baseline vital signs and initiate continuous ECG monitoring
4. Assess need for intravenous access and IVF
5. Consider two peripheral IV's (per Broselow-Luten[®] tape or similar system) and initiate NS IVF (bolus or drip) as indicated
6. Consider IO access early if unable to establish IV access

Disability

1. Assess neurological status
 - A. Assess GCS (record lowest and current) or AVPU level of alertness
 - B. Assess for focal neurological deficits

Additional Considerations

- * Utilize Broselow-Luten[®] tape or similar system to assist with equipment sizes and medication dosages
- * Perform a focused physical exam based on patient's history
- * At any point there is a change in the patient's condition start reassessment at ABC's
- * Obtain blood glucose level if any altered mental status, suspected hypoglycemia, sepsis, seizure, or toxic appearing child

Pediatric Trauma Assessment

Airway

1. Assess airway patency
2. Open airway using standard maneuvers (jaw thrust) maintaining c-spine stabilization
3. Insert oral-pharyngeal airway or nasal-pharyngeal airway as indicated
4. Suction as needed to maintain open airway
5. Assess patient's ability to protect airway per [Airway: Pediatric Protocol](#)

Breathing

1. Assess respiratory effort and rate
2. Assess breath sounds
3. Assess pulse oximetry
4. Administer supplemental oxygen as indicated (nasal cannula, face-mask, BVM) based on respiratory assessment, SpO₂ as available
5. BVM or BIAD per [Airway: BIAD Protocol](#) as indicated

Circulation

1. Control obvious hemorrhage with direct pressure
2. Assess presence and quality of pulses
3. Assess skin color
4. Obtain baseline vital signs and initiate continuous ECG monitoring
 - A. Systolic blood pressure should be $70 + (2 * \text{age in years})$
5. Assess need for intravenous access and IVF
6. Consider largest appropriate sized peripheral IV(s) (per Broselow-Luten tape) or IO access and initiate NS as indicated

Disability

1. Assess neurological status
 - A. Assess GCS (record lowest and current)
 - B. Assess for focal neurological deficits
2. Institute spinal motion restriction as indicated by mechanism of injury and physical exam

Exposure

1. Secondary survey as outlined previously in [Trauma Initial Assessment Protocol](#)
2. Remove appropriate amount of clothing to allow adequate inspection of potential injuries
3. Protect patient from hypothermia

Airway: Adult (AR-1)

Assessment

1. [Medical Initial Assessment Protocol](#) or [Trauma Initial Assessment Protocol](#)
2. Assess for ability to perform BVM ventilations (see addendum)
3. Assess for ability to perform endotracheal intubation (see addendum)
4. Assess for ability to utilize BIAD airway (see addendum)

Basic Medical Care

1. Assess airway status and adequacy of respiratory effort
2. Relieve airway foreign body obstruction per [Airway: Foreign Body Obstruction Procedure](#)
3. Provide supplemental oxygen as required by patient condition
 - A. Goal is SpO₂ = 94 – 97%
4. Perform basic airway maneuvers as required by patient condition
 - A. Head tilt / chin lift
 - i. Do not utilize in acute trauma patients
 - ii. Must maintain c-spine motion restriction in trauma patients
 - B. Jaw thrust
 - C. Utilize nasal or oral pharyngeal airway as indicated per patient condition
5. Assistance with Bag Valve Mask as indicated per patient condition
6. Insert BIAD per [Airway: BIAD-Protocol](#) as indicated

Advanced Medical Care

1. Consider CPAP as indicated per patient condition
2. Perform intubation as required by patient condition per [Airway: Intubation Protocols](#)
 - A. Orotracheal intubation
 - B. Nasotracheal intubation
3. [Airway: Adult – Failed Protocol](#) as indicated
4. Utilize ETCO₂ monitoring in any patient with a BIAD or ETT placed
5. Place orogastric tube in any patient with a BIAD or ETT placed
6. The receiving/destination facility must be notified of the status of any difficult airway or use of any advanced airway device

Additional Considerations

- * Endotracheal intubation can be performed using a variety of techniques
 - Orotracheal
 - Blind nasotracheal
 - Reserved for patients with clear need of ETI and oropharyngeal access is not possible (e.g. massive angioedema of tongue/lips)
- * Nasotracheal intubation is contraindicated in cases of:
 - Apnea
 - Cardiac arrest
 - Coagulopathy
 - Combative patient
 - Facial trauma
 - Severe head injury
 - Suspected foreign body in upper airway
 - Upper airway trauma
- * Proper airway device positioning must be verified after each patient movement
 - To/from EMS stretcher
 - Loading/unloading from ambulance
- * Maintain ETCO_2 35 – 45 mmHg
 - Exception: clinical condition with significant metabolic acidosis (e.g. aspirin overdoses) in which a lower level is compensatory and required
 - Exception: clinical condition in which a permissive hypercapnia is beneficial to permit adequate exhalation time (e.g. asthma exacerbation)

Airway Management: Adult (Addendum)

Indicators of difficulty to perform mask ventilation

- * **R**adiation / **R**estriction (poor lung compliance)
 - Asthma, COPD
 - ARDS
 - Term pregnancy
- * **O**besity / **O**bstruction / **O**bstructive sleep apnea
- * **M**ask seal / **M**allampati
- * **A** > 55 years
- * **N**o teeth

Indicators of difficult intubation

- * **L**ook at head & neck for anatomical difficulties or injuries
- * **E**valuate for 3-3-2
 - 3 fingers in oral opening
 - 3 fingers between hyoid and midline of jaw
 - 2 fingers from hyoid to thyroid cartilage
- * **M**allampati
- * **O**bstruction
- * **N**eck immobility

Indicators of difficult use of BIAD device

- * **R**estricted oral opening
- * **O**bstruction or obesity
- * **D**istorted airway anatomy
- * **S**tiff lungs



**adapted from *Manual of Emergency Airway Management 5th Edition* and *The Airway Course*

Airway: Adult – Failed (AR-2)

Definition

- * Failed intubation = failed attempt(s) at intubation by ALS provider
- * Failed airway = failure to intubate + failure to oxygenate / ventilate by any means

Caveats

- * A single failed attempt does not equate to a failed airway
 - BVM or supra-glottic device can be utilized to maintain SpO₂ > 90%
 - Any intubation attempt must cease when SpO₂ falls to ≤ 90%
- * No one crew member shall make more than two (2) attempts at intubation
- * No more than a total of three (3) attempts at intubation, shall be made by all paramedics on scene
- * Consider cause(s) of failed attempt and make appropriate adjustments prior to next attempt at intubation
- * Use of a rescue device may be performed at any time crew feels that further attempts would not result in endotracheal intubation and therefore this would be in the best interest of the patient
- * Oxygenation / ventilation via BVM may be needed to maintain SpO₂ > 90% between attempts at intubation

Assessment

1. Can the patient effectively be oxygenated and ventilated with a BVM
2. Can BIAD be placed safely
3. Can intubation adjunct be utilized to assist in securing correct ETT placement

Management

1. Following failed attempt at intubation, oxygenation / ventilation must be ensured
2. Place BIAD as per [Airway: BIAD-Protocol](#)
3. Airway may be managed with BVM alone if adequate oxygenation / ventilation ensured
4. Utilize ETCO₂ continuous waveform monitoring in all patients with BIAD or ETT in place
5. Medical Control must be notified prior to arrival of any failed airway or failure to perform endotracheal intubation even if patient able to be well managed with BVM or BIAD

Additional Considerations

- * Maintain SpO₂ = 94-97%
- * Maintain ETCO₂ = 35 – 45 mmHg
 - Exception: clinical condition with significant metabolic acidosis (e.g. aspirin overdoses) in which a lower level is compensatory and required
 - Exception: clinical condition in which a permissive hypercapnia is beneficial to permit adequate exhalation time (e.g. asthma exacerbation)

Airway: Pediatric (AR-5)

Assessment

1. [Pediatric Initial Assessment Protocol](#) or [Pediatric Trauma Assessment Protocol](#)
2. Assess for ability to perform BVM ventilations
3. Assess for ability to utilize supra-glottic device

Basic Medical Care

1. Assess airway status and adequacy of respiratory effort
2. Provide supplemental oxygen as required by patient condition
3. Perform basic airway maneuvers as required by patient condition
 - A. Head tilt / chin lift
 - i. Must maintain c-spine motion restriction in trauma patients
 - B. Jaw thrust
 - C. Assistance with Bag Valve Mask
4. Place BIAD as per [Airway: BIAD Protocol](#)
5. Utilize ETCO₂ monitoring in any patient with a BIAD placed

Advanced Medical Care

1. Perform Intubation as required by patient condition per [Airway: Intubation Orotracheal Protocol](#)
 - Only for patients \geq 15-years of age
2. Follow [Airway: Pediatric Failed Intubation Protocol](#) as indicated
3. Bag-valve-mask ventilation
4. Utilize ETCO₂ monitoring in any patient with an ETT placed

Additional Considerations

- * Utilize Broselow-Luten[®] tape for assistance with equipment size selection
- * Basic airway maneuvers with proper technique BVM may be the preferred method of airway maintenance in many patients
- * Blind nasotracheal is contraindicated in pediatric patients (< 15 years old)
- * Maintain SpO₂ = 94 – 97%
- * Maintain ETCO₂ 35 – 45 mmHg
 - Exception: clinical condition with significant metabolic acidosis (e.g. aspirin overdoses) in which a lower level is compensatory and required
 - Exception: clinical condition in which a permissive hypercapnia is beneficial to permit adequate exhalation time (e.g. asthma exacerbation)
- * Ventilatory rates
 - Neonate = 30 per minute
 - Toddler = 25 per minute
 - Children = 20 per minute

Airway: Pediatric – Failed (AR-6)

Definition

- * Failed intubation = failed attempt(s) at intubation by both crew members on scene
- * Failed airway = failure to intubate + failure to ventilate (can't intubate/can't ventilate)

Caveats

- * A single failed attempt does not equate to a failed airway
- * No one paramedic shall make more than two (2) attempts at intubation
 - Only patients \geq 15-years of age
 - No more than a total of three (3) attempts at intubation, shall be made by all paramedics on scene
 - *Consider cause(s) of failed attempt and make appropriate adjustments prior to next attempt at intubation*
- * Use of a rescue device may be performed at any time crew feels that further attempts would not result in endotracheal intubation and therefore this would be in the best interest of the patient
- * Oxygenation / ventilation via BVM may be needed to maintain $SpO_2 > 90\%$ between attempts at intubation

Assessment

1. Can the patient effectively be oxygenated and ventilated with a BVM

Basic Medical Care

1. Place BIAD as per [Airway: BIAD Protocol](#)
2. Following failed attempt at BIAD insertion, oxygenation / ventilation must be ensured, use of a BVM may be necessary
 - A. Maintain $SpO_2 = 94 - 97\%$
 - B. Utilized nasopharyngeal or oropharyngeal airway as indicated
3. Crew may elect to manage airway with BVM alone if adequate oxygenation / ventilation is ensured

Additional Considerations

- * Maintain $SpO_2 = 94 - 97\%$
- * Maintain $ETCO_2 35 - 45$ mmHg
 - Exception: clinical condition with significant metabolic acidosis (e.g. aspirin overdoses) in which a lower level is compensatory and required
 - Exception: clinical condition in which a permissive hypercapnia is beneficial to permit adequate exhalation time (e.g. asthma exacerbation)

Pain Control (UP-11)

Objective

- * To provide pain relief and reduce anxiety during transport

Clinical Presentation

- * Assess location of pain and pain severity
- * Trauma vs. non-trauma related pain
- * Acute vs. chronic
- * Aggravating vs. alleviating factors

Management

1. [Medical Initial Assessment Protocol](#) or [Trauma Initial Assessment Protocol](#)
2. [Pediatric Initial Assessment Protocol](#) or [Pediatric Trauma Assessment Protocol](#)
3. Treat patient condition as per appropriate protocol
4. Assess patient's pain severity as per [Assessment: Pain Procedure](#)
5. Refer to specific medication on the following pages for dosing guidelines
6. It may be appropriate to contact Medical Control prior to narcotic administration in patients with acute multi-system trauma
 - A. Situations may arise at trauma scenes that medication administration may be warranted prior to full evaluation to successfully extricate patient from vehicle or other entrapment type position
7. Narcotic medication administration should be avoided in the following patients:
 - A. Acute brain injury
 - B. Altered mental status
 - C. Acute intoxication / drug overdose
 - D. CNS disease
8. Narcotic medication should be administered at lower doses and with caution in hypotensive (SBP < 90 mmHg) / hemodynamically unstable patients
9. IV medications should be given by slow push over 1 – 2 minutes
10. Reassess patient's response to treatment
11. Reassess patient's pain severity and vital signs prior to subsequent doses
12. Following two (2) doses given by protocol, contact Medical Control for further orders
13. Refer to case specific protocols for further pain management

Fentanyl

1. Dose
 - A. Adult
 - i. 0.5 – 1 mcg/kg IV, IM, IO (maximum 100 mcg)
 - ii. 1 – 2 mcg/kg IN (maximum 200 mcg)
 - iii. ***It is acceptable to give a lower dose, as indicated, based upon the patient's clinical condition***
 - B. Pediatric
 - i. 0.5 – 1 mcg/kg IV, IM, IO, IN (maximum 100 mcg)
 - ii. ***It is acceptable to give a lower dose, as indicated, based upon the patient's clinical condition***
 - C. Must be given slowly
 - D. Titrate second dose in 15 minutes based on patient's response / condition
 - i. Adults: maximum dose 100 mcg any route
 - ii. Pediatrics Medical Control order is required for repeat dosing
2. Contraindications – absolute
 - A. Known hypersensitivity reaction
3. Contraindications – relative
 - A. Altered mental status
 - B. Hypotension [SBP < 90 mmHg adult; < 70+(2*age in years) mmHg pediatric]
4. Adverse effects
 - A. Chest wall rigidity can occur with too rapid infusion
 - B. Respiratory depression
 - C. Depressed level of consciousness
 - D. Hypotension
 - E. Nausea / vomiting
5. Reversal
 - A. Adult = naloxone (Narcan®) 2 mg IV, IM
 - B. Naloxone does not reverse chest wall rigidity

Nitrous Oxide

1. Dose adult & pediatric patients
 - A. 50:50 mixture via self-administered device
2. Contraindications
 - A. Bowel obstruction
 - B. Hypotension
 - C. Pneumothorax
 - D. Pregnancy (patient or provider)
 - E. Significant respiratory compromise

Acetaminophen (Tylenol®)

1. Dose
 - A. Adult: 650 – 975 mg PO
 - B. Pediatric: 15 mg/kg PO (maximum 650 mg)
2. Contraindications
 - A. Known hypersensitivity reaction
 - B. Significant liver disease
3. Adverse effects
 - A. Angioedema
 - B. Hepatotoxicity
 - C. Rash

Ibuprofen (Motrin®)

1. Dose
 - A. Adult: 400 – 800 mg PO
 - B. Pediatric: 10 mg/kg PO (maximum 400 mg)
2. Contraindications
 - A. Known hypersensitivity
 - B. Age < 6 months
 - C. Gastrointestinal ulcer disease / bleeding
 - D. NPO status
 - E. Renal disease
3. Adverse effects
 - A. Gastrointestinal distress

Additional Considerations

- * Narcotic analgesics should be avoided in the treatment of chronic pain or chronic pain syndromes

Medical Monitoring (SO-1/SO-2)

Objective

- * The purpose of this protocol is to provide guidelines for MEDIC personnel at incidents where the primary role is to monitor the health and wellbeing of other allied agency personnel

Introduction

- * MEDIC may be called to the scene of an extended public service function or public safety operation
- * In addition to providing medical care for ill or injured civilians at the scene; MEDIC will be responsible for the medical monitoring of allied agency personnel participating in the event
- * Event may involve working fires, evacuations, police actions, or recovery operations
- * Depending on resources, it is recommended that a dedicated rehabilitation team be assigned to the incident, while additional resources are called in for civilian incident casualties
- * These incidents may constitute a dangerous or potentially hazardous working environment for all those involved
- * Important considerations include public safety personnel rehabilitation (ensuring rest and hydration), monitoring of physical and mental status, and relief from extreme environmental conditions

Considerations

- * Upon scene arrival, MEDIC personnel will identify and report to the scene Incident Command to receive instructions on roles and responsibilities
- * Ensure appropriate measures for active cooling or warming per environmental conditions
- * A medical monitoring location should be identified which is both safe and proximate to identify individuals at risk
 - The ambulance should be positioned such that exit routes are easily attainable
 - The site should be protective from extreme environmental conditions and those resulting from the incident scene
 - The site should be large enough to accommodate multiple personnel
 - There should be clear entrance and egress routes
- * Regardless of the incident, the following equipment and supplies must be readily available:
 - Airway supplies and oxygen
 - Cardiac monitor/defibrillator
 - Medications

- * Rehydration is the most important function in medical rehabilitation
 - Protocols for hydration include the following:
 - During heat stress activity, consumption should reach a goal of 1 quart of fluid intake per hour
 - Fluids should include water or a 50:50 mixture of water and activity beverage (Gatorade®, PowerAde®)
 - This should be accomplished regardless of hot or cold ambient temperatures
 - Caffeine and carbonated drinks are contraindicated
- * Food should be considered for incidents extending beyond 3 hours
 - The following are considerations:
 - Soups, broths, stew
 - Fruits
 - Fatty and salty foods (constitutes most fast food) are contraindicated
 - Caffeinated or carbonated beverages are contraindicated
- * Rest protocols should include the following:
 - For every 45 minutes of work time (equivalent to 2 SCBA air bottles), no less than 10 minutes of rest and monitoring should be required
 - Extended periods may be warranted depending on the individual's health status
 - During extremely hot periods of work, avoid air-conditioned environments initially
 - A cool down period in the ambient environment is mandatory initially
 - Active cooling (e.g. forearm immersion in an ice bath, is encouraged)
- * Vital signs should be checked immediately and every 20 minutes while in the rehabilitation area
- * Vital sign protocols are as follows:
 - Pulse rate > 150 beats per minute, or rate reaches 90% of predicted maximum rate (determined by: $220 - \text{age}$), and/or systolic blood pressure > 180 or < 100 mmHg:
 - Remove from work environment
 - Remove personal protective equipment and as much protective clothing as able
 - Use external cooling sources (fans/misters/ice bath) as available
 - Encourage oral hydration
 - Pulse rate < 100 beats per minute and systolic blood pressure >100 and <180 mmHg:
 - May return to work

- * If available, utilize a Rad 57 to obtain carboxyhemoglobin level
- * **Initial SpCO level**

<u>Initial SpCO level</u>	<u>Protocol</u>
➤ < 3%	Return to work
➤ 3% to 12% and no symptoms	Return to work
➤ > 3% and symptoms; or > 12%	Oxygen via NRB mask & transport
- * Symptoms of CO toxicity:
 - Headache, shortness of breath, nausea, vertigo, confusion, loss of consciousness
- * Any personnel with chest pain, shortness of breath, or nausea should be transported to a medical facility for treatment
- * Various minor traumatic injuries may also be seen in the rehabilitation area
- * If there is a potential for worsening of the injury or impaired performance by returning to active on-scene duty, the involved personnel may not return to duty
- * Both psychological and physiological stress should be evaluated
 - Psychological stress may include the following:
 - inappropriate emotional outbursts
 - aggressive behavior
 - uncontrolled emotions
 - depressed attitude or blunt affect
 - Physiologic stress may include the following:
 - chest discomfort
 - trouble breathing
 - unstable vital signs
 - heat-related illness
 - altered mental status

Working Fires

- * MEDIC personnel will ordinarily be dispatched to the scene when the Charlotte Fire Department or a Mecklenburg County Volunteer Fire Department is engaged in fire suppression activities
- * At the scene of a working fire, firefighters will be in standard turnout gear
 - Although protective, this gear greatly increases the risk for heat-related
 - In addition, firefighters will be undergoing profound physical stress due to mobilization of equipment and firefighting functions
- * Firefighters will rotate out of active duty for rehabilitation after expending two SCBA air bottles or canisters
 - Each bottle lasts approximately fifteen minutes; therefore, firefighters should rotate out every thirty minutes.
- * Complaints related to heat illness may include the following:

➢ Chest pain	➢ Fatigue
➢ Shortness of breath	➢ Muscle cramps
➢ Headache	➢ Nausea and vomiting
➢ Altered mental status	➢ Malaise

Basic Medical Care

1. Remove patient from any warm/hot, smoke-filled environment
2. Use external cooling sources (fans or misters) as available
 - A. Moving to a cool, air-conditioned environment (fixed facility, transit bus, ambulance) as available is indicated after a cool-down period
3. Remove any protective clothing to facilitate cooling
4. If any medical illnesses or traumatic injuries are noted, refer to appropriate protocol
5. For potential for inhalational injury, oxygen via non-rebreathing mask at 15 L/min
6. Obtain vital signs
7. If available, utilize a Rad 57 to obtain carboxyhemoglobin level
8. **Initial SpCO level**

	Protocol
A. < 3%	Return to work
B. 3% to 12% and no symptoms	Return to work
C. >3% & symptoms; or > 12%	Oxygen via NRB mask & transport
9. Symptoms of CO toxicity:
 - A. Headache, shortness of breath, nausea, vertigo, confusion, loss of consciousness
10. If nausea & vomiting is absent, encourage oral hydration
11. For patient considered having heat stroke, cool central body regions with ice packs (scalp, axilla, groin, chest, and abdomen)
 - A. Keep skin cool and moist by applying cool compresses
12. For patient considered hypothermic, immediately remove from the environment into a warm setting and protect from further heat loss
 - A. Remove cold, wet clothing and apply warm blankets
 - B. Massaging extremities is contraindicated

13. Continue to monitor vital signs
 - A. HR > 110 or RR < 8 or > 40 → continue rehabilitation and reassess in 10 minutes
 - B. SBP ≥ 160 or DBP ≥ 100 → if firefighter is symptomatic; continue rehabilitation and reassess in 10 minutes
 - C. Temp ≥ 100.6 → if firefighter is symptomatic; continue rehabilitation and reassess in 10 minutes

Advanced Medical Care

1. Obtain rhythm strip and refer to appropriate protocol as indicated
2. For firefighter or patient burned:
 - A. **IV Access Protocol**
 - B. IVF resuscitation as indicated per patient presentation
 - i. Adult
 1. Hemodynamically unstable or large TBSA burn (≥ 25%): wide open
 2. Hemodynamically stable and small TBSA burn (< 25%): TKO
 - ii. Pediatric
 1. Hemodynamically unstable or large TBSA burn (≥ 25%): 20ml/kg
 2. Hemodynamically stable and small TBSA burn (< 25%): TKO
3. Fentanyl for pain control
 - A. Adult
 - i. 0.5 – 1 mcg/kg IV, IM, IO (maximum 100 mcg)
 - ii. 1 – 2 mcg/kg IN (maximum 200 mcg)
 - iii. May repeat x1 in 15 minutes as indicated (maximum 100 mcg)
 - B. Pediatric
 - i. 0.5 – 1 mcg/kg IV, IO, IN (maximum 100 mcg)
 - ii. Contact Medical Control for repeat dosing
4. HR > 85% NFPA age predicted maximum (per years of age)
 - 20 – 25 = 170 BPM
 - 26 – 30 = 165 BPM
 - 31 – 35 = 160 BPM
 - 36 – 40 = 155 BPM
 - 41 – 45 = 152 BPM
 - 46 – 50 = 148 BPM
 - 51 – 55 = 140 BPM
 - 56 – 60 = 136 BPM
 - A. IVF 1 – 2 liters as per patient condition
 - B. No improvement → initiate transport to emergency department
5. Advanced Airway management as indicated
 - A. **Airway: Intubation Protocol**
 - B. **Airway: BIAD Protocol**
6. Ensure proper tube placement using capnometry, SpO₂ and ventilate with 100% oxygen
7. Additional care as per appropriate protocol per presentation of illness/injury

Additional Considerations

- * Stopping the burning process by soaking or irrigating the burned area with water or saline should only be performed within minutes after the patient is removed from the exposure
 - Only saline or a clean water source should be used
 - Ice, other water sources (lake water), or ointments should never be used.
 - Cooling should only be performed for 1 to 2 minutes
 - The end-point is not palpable cool skin, but a 1 to 2-minute time frame
 - Cooling with water is considered useless and potentiates hypothermia if performed outside of this 1 to 2-minute time frame from exposure
- * Heat related illness
 - Heat exhaustion may be distinguished from heat stroke in that diaphoresis will be present with exhaustion, whereas this finding may be absent with heat stroke
 - Heat stroke is defined by altered mental status in the setting of heat related illness
- * The average adult male requires approximately 500-600 mL/hour of fluid while performing moderate activity to maintain body homeostasis
- * Consider associated cyanide toxicity
 - Patient may complain of headache, nausea, vomiting, chest pain, dizziness, altered mental status, or a syncopal event
 - High flow oxygenation is paramount for these patients
 - Pulse oximetry measurements may be falsely elevated
 - Treatment: sodium thiosulfate
 - Adults: 12.5 grams IV over 10 minutes
 - Pediatrics: 250 mg/kg IV (maximum 12.5 grams) over 10 minutes

Hazardous Materials

- * MEDIC personnel may be dispatched when the Charlotte Fire Department Hazardous Materials Team is involved in the management and containment of a radiation, biological, or chemical incident
- * For incidents involving such hazardous materials, strict communication and coordination with the fire department Hazardous Materials Team must be established
- * At the scene of a hazardous materials incident, firefighters will be in one of three levels of turnout gear for a nuclear, biological, or chemical release or spill (A,B,C):
 - Level A
 - Provides the maximal amount of vapor and splash protection
 - Fully encapsulating and used with a supplied air source (SCBA)
 - Maximum work time is 15 to 20 minutes
 - Level B
 - Resistant against vapor and splash exposure
 - Partially encapsulating and used with a supplied air source (SCBA)
 - Maximum work time is 1 to 2 hours
 - Level C:
 - Resistant against vapor and splash exposure
 - Partially encapsulating and used with a charcoal-filtered respirator; either a charcoal-filtered mask or a powered air purifying respirator
 - Maximum work time is 4 to 6 hours
 - Level D
 - Regular turnout work garment
 - Respiratory protection not required
- * For radiation accidents, levels of protective clothing vary depending upon the rescuer's level of exposure to the site
 - Those in the inner perimeter (hot zone) will be in complete protective suits
- * All levels and types of protective gear greatly increase an individual's risk for heat illness
- * In addition, rescue personnel will be undergoing profound physical stress due to mobilization of equipment and resources, containment of the incident, and civilian rescue
- * MEDIC personnel should anticipate & ensure that operations personnel rotate from active duty for rehabilitation
- * No attempt should be made to access patients or other personnel who have not been properly decontaminated
- * Complaints related to heat illness may include the following:

➤ Chest pain	➤ Fatigue
➤ Shortness of breath	➤ Muscle cramps
➤ Headache	➤ Nausea and vomiting
➤ Altered mental status	➤ Malaise
- * Patients with profound vomiting, diarrhea, and mental status changes should be considered to have suffered an acute exposure and should be rapidly transported to the nearest medical facility after proper decontamination procedures

Basic Medical Care

1. Ensure scene safety and a protective environment for all personnel and patients
2. Additional precautions (distance and shielding) should be considered when radiological agents are involved
3. Ensure that fire department resources (Hazardous Materials Team) has been notified and have been dispatched
4. Attempt to identify exposure (bystander or worker information, incident location, environmental indicators, container description, placards or labels, shipping papers or Material Safety Data Sheets, patient symptoms)
5. Apply appropriate personal protective equipment
 - A. The decision for type and level will be made by the scene Incident Command
6. Immediately remove all patients from the exposure and determine the level of contamination present
7. Determine the need for decontamination prior to full assessment and treatment
 - A. Vapor material source
 - i. Remove from source of contamination
 - B. Liquid material source
 - i. Remove contaminated equipment and clothing and perform gross and technical showering decontamination procedures
 - C. Solid material source
 - i. Remove material by physical measures of brushing away source, then gross and technical showering decontamination procedures if indicated
8. If any medical illnesses or traumatic injuries are noted, refer to appropriate protocol
9. Maintain airway; suction as needed
10. Provide assisted ventilations with bag-valve mask and 100% oxygen if breathing or ventilatory compromise is apparent
 - A. Consider use of a nasopharyngeal or oropharyngeal airway as an adjunct
11. If potential for inhalational injury, provide supplemental oxygen as indicated
12. Obtain vital signs
13. If nausea or vomiting is absent, encourage oral hydration
14. For patient considered being heat stroke
 - A. Cool central body regions with ice packs (scalp, axilla, groin, chest, and abdomen)
 - B. Keep skin cool and moist by applying cool compresses
15. For patient considered hypothermic
 - A. Immediately remove from the environment into a warm setting and protect from further heat loss
 - B. Remove cold, wet clothing and apply warm blankets
 - C. Massaging extremities is contraindicated
16. For eye exposure, irrigate copiously with sterile saline
17. Continue to monitor vital signs
18. Albuterol via hand held or mask nebulizer for bronchospasm or reactive airway disease
 - A. Adult: 5 mg; repeat 5 mg for persistent symptoms
 - B. Pediatric: 2.5 – 5 mg; repeat 2.5 – 5 mg for persistent symptoms

Advanced Medical Care

1. Obtain 4-lead and refer to appropriate protocol as indicated
2. Assess hydration status, need for intravenous fluids
3. IVF resuscitation as indicated per patient presentation
 - A. Adult
 - i. Hemodynamically unstable: wide open
 - ii. Hemodynamically stable: TKO
 - B. Pediatric
 - i. Hemodynamically unstable: 20ml/kg bolus
 - ii. Hemodynamically stable: TKO
4. Albuterol via hand held or mask nebulizer for bronchospasm or reactive airways disease,
 - A. Adult = 5 mg
 - i. Repeat 5 mg for persistent wheezing
 - B. Pediatric = 2.5 – 5 mg
 - i. Repeat 2.5 - 5 mg for persistent wheezing
5. Advanced Airway management as indicated
 - A. [Airway: Intubation Protocol](#)
 - B. [Airway: BIAD Protocol](#)
6. Ensure proper tube placement using capnometry, SpO₂ and ventilate with 100% oxygen
7. Additional care as per appropriate protocol per presentation of illness/injury

Additional Considerations

- * Ensure that the scene is safe and appropriate resources are available before approaching the scene or patient
 - Wind direction and fluid run-off should be primary considerations
- * Toxicity from hazardous materials may be the result of inhalation, ingestion, absorption, or injection
 - Clinical signs and symptoms may be internal or external depending on route of exposure
- * In any setting involving noxious gas inhalation, high flow oxygenation is paramount for these patients
 - High levels of SpO₂ (including 100%) do not reflect the degree of oxygenation
 - All patients with potential exposures should be administered 100% oxygen by non-rebreathing mask
- * The **NC Poison Center** may provide assistance and is available 24-hours a day
 - **800-222-1222**

Police Operations

Introduction

- * MEDIC personnel may be dispatched to the scene of any incident in which the Charlotte-Mecklenburg Police Department or Federal Bureau of Investigation Special Weapons and Tactics (S.W.A.T.) team is deployed
- * At the scene of a police or S.W.A.T. call-out, team members will be in tactical gear, which may include Kevlar body armor and helmets
 - While protective against penetrating injury, this clothing may increase the risk for heat-related illness
 - Further, team members may be engaged in profound physical exertion involving equipment transport and resource deployment
- * Depending upon the tactical situation, team members may be exposed to environmental extremes for prolonged periods of time
- * Additional environmental hazards may include insect bites/stings or mammalian/reptilian bites
- * Penetrating, blast, or other traumatic injuries should be treated per protocol

Basic Medical Care

1. Confirm scene safety and ensure a protective environment for yourself and the patient
2. Place patient in most comfortable position
3. For any medical illnesses or traumatic injuries noted, refer to appropriate protocol
4. Wound care as indicated per patient presentation
5. For uncontrolled hemorrhage noted to an extremity that cannot be controlled with direct pressure, consider any or all the following:
 - A. MEDIC tourniquet application per [Wound Care – Tourniquet Protocol](#)
 - B. Hemostatic dressing
6. Provide supplemental oxygen as indicated per patient condition
7. Assess vital signs

Advanced Medical Care

1. Obtain 4-lead and refer to appropriate protocol as indicated
2. IVF as indicated per patient presentation
 - A. Hemodynamically unstable
 - i. Adults: wide open
 - ii. Pediatrics: 20 ml/kg IV and reassess
 - B. Hemodynamically stable: TKO
3. For penetrating traumatic injury results in an open chest wound, consider the following:
 - A. Hydrogel occlusive dressing (chest seal)
 - B. For hemodynamically unstable: chest needle decompression

Police Custody (UP-12)

Basic medical Care

1. Confirm scene safety and ensure a protective environment for yourself and the patient
2. Medical illnesses or traumatic injuries treatment per protocol as indicated
3. Wound care as indicated per patient presentation
4. For uncontrolled hemorrhage noted to an extremity that cannot be controlled with direct pressure, consider any or all the following:
 - A. MEDIC tourniquet application per [Wound Care – Tourniquet Protocol](#)
5. Assess vital signs
6. Provide supplemental oxygen as indicated per patient condition for SpO₂ = 94 – 97%
7. Pepper spray
 - A. Remove contaminated clothing
 - B. Irrigate with copious amounts of normal saline or water
 - C. Administer albuterol via nebulizer for exacerbation of reactive airway disease
8. Taser deployment
 - A. [Wound Care – Conducted Electrical Weapon Protocol](#)

Advanced Medical Care

1. Medical illness or traumatic injury treatment per protocol as indicated
2. Obtain 4-lead and refer to appropriate protocol as indicated
3. IVF as indicated per patient presentation
 - A. Hemodynamically unstable: wide open
 - B. Hemodynamically stable: TKO
4. For signs of hyperactive delirium with extreme agitation
 - A. IVF: wide open
 - B. Midazolam (Versed®) 5 mg IV, IM or 10 mg IN for BARS score \geq 5
 - C. Ketamine (Ketalar®) 3 mg/kg IM (maximum 300 mg) for BARS score = 7

Additional Considerations

- * Patients in police custody retain the right to participate in decision making regarding their healthcare and may request care of EMS
- * Patients in police custody retain the right to refuse medical care as long as the patient has the capacity to make an informed decision and understands the risks of refusing treatment and the benefits of accepting medical treatment
- * Deaths associated with Conducted Electrical Weapons (CEW) devices have been associated with “hyperactive delirium with extreme agitation”
 - A hyperdopaminergic state characterized by extreme aggression, shouting, delusions, paranoia, strength, and hyperthermia
 - Most commonly seen in males with history of serious mental illness or drug use
 - It is more common with cocaine, methamphetamine, or similar drug use
 - Requires supportive care with IVF administration and midazolam as indicated
- * Midazolam or ketamine will NEVER be administered to facilitate arrest or on PD request

Diving Operations

Introduction

- * First responder and Medic personnel may be dispatched to the scene of a possible drowning or missing person in which rescue personnel are involved in a water rescue or recovery operation
- * This may involve diving-related illness, drowning, or environmental-related illness
- * Body cooling occurs rapidly in water
 - Hypothermia can ensue in water temperatures of 70-80° F
- * MEDIC personnel should expect operations personnel to systematically rotate out of active duty for rehabilitation
- * No attempt should be made to access patients who have not been removed from the water
- * Complaints related to hypothermia may include the following:
 - Malaise
 - Altered mental status
 - Fatigue
 - Nausea
- * Complaints related to diving injuries may include the following:
 - Arthralgias
 - Altered mental status
 - Myalgias
 - Shortness of breath
 - Headache
- * Divers with specific complaints, such as respiratory distress, chest pain, burns, or falls should be treated per protocol

Basic Medical Care

1. Confirm scene safety and ensure a protective environment for yourself and the patient
2. For patient still in water, prepare for resuscitation once rescue is affected
3. For patient found in cool, adverse environment, remove to appropriate warmer setting
4. If trauma to head or spine is suspected (fall from height, boating or other watercraft accident, diving accident) maintain control of the cervical and thoracolumbar spine
 - A. Attempt to remove patient from water in a horizontal position
5. Check for breathing and pulses
 - A. If apneic and pulseless, initiate CPR for the following conditions:
 - i. Submersion time is less than 30 minutes in all patients
 - ii. Submersion time is less than 45 minutes and water temperature < 50°F
6. Maintain airway; suction as needed
7. Provide assisted ventilations with bag-valve mask and 100% oxygen if breathing or ventilatory compromise is apparent
8. Assess vital signs
9. Provide supplemental oxygen
10. Remove appropriate clothing to fully inspect extremities, chest, and abdomen for any significant injuries

11. Medical illnesses or traumatic injuries treatment as per indicated protocol
12. For suspected spinal trauma, maintain cervical spinal motion restriction at all times
 - A. Place patient on a long backboard as necessary/indicated for patient movement
 - B. While log rolling patient, inspect the back and axilla for any additional injuries
13. For patient determined to be hypothermic, consider the following:
 - A. Place patient in most comfortable position and remove any wet or damp clothes
 - B. Insulate patient as much as possible with blankets
 - C. Gently move patient to warm ambulance as soon as possible
14. For patient noted to have isolated areas of frostbite, remove any obstructive clothes or coverings and protect from further injury
 - A. Blisters should remain intact
15. Prohibit ambulation and use of tobacco products
16. Assess blood glucose
 - A. Treatment as per [Diabetic Problems Protocol](#)
17. Albuterol via hand held or mask nebulizer for bronchospasm or reactive airway disease
 - A. Adult: 5 mg; repeat as indicated per patient condition
 - B. Pediatric: 2.5 – 5 mg; repeat as indicated per patient condition

Advanced Medical Care

1. Obtain rhythm strip and refer to appropriate protocol as indicated
2. Albuterol for bronchospasm or reactive airways disease outlined as above
3. For persistent respiratory distress in alert patient:
 - A. Adult: CPAP per [Respiratory NIPPV Protocol](#)
4. Advanced Airway management as indicated
 - A. [Airway: Intubation Protocol](#)
 - B. [Airway: BIAD Protocol](#)
5. Ensure proper tube placement using capnometry, SpO₂ and ventilate with 100% oxygen
6. Additional care as per appropriate protocol per presentation of illness/injury

Additional Considerations

- * Always ensure that the scene is safe before approaching the patient
- * Some patients, particularly children, can survive extended periods of submersion in very cold water
 - Even in situations where the patient's pupils were fixed and dilated, and the resuscitation was prolonged, patients have had good clinical outcomes
 - Rewarming techniques must be initiated to achieve core body temperature greater than 86° F before resuscitation can be terminated
- * Dysrhythmias, primarily ventricular fibrillation, are common at core temps < 86° F
 - Hypothermic patients presenting in cardiac arrest should have no cardiac medications, cardioversion, pacing, or defibrillation until rewarmed
 - The primary treatment is active core rewarming

- * If PEA suspected, auscultate for heart sounds over the precordium prior to initiating treatment per protocol (hypothermia may result in decreased peripheral pulses)
- * All non-fatal drowning patients, with or without aspiration, must be transported to the hospital for observation and to evaluate for development of laryngospasm, pulmonary edema, and Acute Respiratory Distress Syndrome (ARDS)
 - Encourage any nonfatal drowning patient to not refuse care or transport
- * Diving related injuries
 - Barotrauma
 - Middle ear squeeze is the most common complaint of SCUBA divers
 - Inner ear barotrauma – vertigo, unilateral tinnitus, hearing loss
 - Other: sinus barotrauma, mask squeeze, barodontalgia
 - Nitrogen narcosis
 - Occurs at depths > 100 feet
 - Impaired judgment
 - Alternobaric vertigo
 - Unequal middle ear pressures; occurs with ascent
 - Vertigo typically self-limited (descending few feet may resolve)
 - Decompression injury
 - Occurs with ascending too rapidly
 - Symptoms within 12 hours of ascent
 - Fatigue, joint pain, CNS disturbances
 - Type I – joint pain, skin rash
 - Type II – paresthesia, dizziness/vertigo, nausea, headache, paralysis, dyspnea, chest pain, loss of consciousness
 - Type III – pulmonary complications: pneumothorax, pneumomediastinum
 - Air embolism
 - Rapid onset of symptoms (within 10 minutes of ascent)
 - Loss of consciousness, confusion, stupor, apnea, cardiac arrest
 - Management
 - Assess ABC's and vital signs
 - Provide supplemental oxygen
 - Left lateral decubitus positioning
- * Available decompression chambers
 - Healogics – Charlotte, NC**
 - **704-807-1513**
 - May not be available 24 hours/day
 - Duke University – Durham, NC
 - **919-680-8111** – contact the HBO Attending or Fellow on-call
 - Richland Palmetto Hospital – Columbia, SC
 - **803-434-7000** – contact the HBO physician on-call
- * Additional resources
 - Diver's Alert Network
 - **919-684-9111**
 - **800-446-2671**

Abdominal Pain, Vomiting & Diarrhea (UP-3)

Differential Diagnosis

- * Abdominal aortic aneurysm
- * Appendicitis
- * Bowel obstruction
- * Cholelithiasis / cholecystitis
- * Constipation
- * Diverticulitis
- * DKA
- * Dysmenorrhea
- * Gastritis
- * Gastroenteritis
- * Hepatitis
- * Hernia
- * Ischemic bowel
- * Kidney stone
- * Myocardial infarction / ischemia
- * Pancreatitis
- * Pelvic (ovarian cyst, PID)
- * Peptic ulcer disease
- * Pneumonia
- * Pregnancy
- * Pyloric stenosis
- * Substance abuse
- * Trauma
- * Urinary tract infection

Clinical Presentation

- * History considerations
 - Age
 - Past medical history
 - Past surgical history
 - Medications
 - OB/Gynecological history
 - Gravida
 - Parity
 - LMP
 - Travel outside of U.S.
- * Duration, location, character of pain
- * Associated symptoms
 - Anorexia
 - Constipation
 - Fever
 - Hematemesis, hematochezia, melena
 - Nausea, vomiting
- * Aggravation or alleviating factors
- * Physical exam
 - Focused abdominal exam
 - Inspect for prior incision scars
 - Auscultate bowel sounds (increase with obstruction), bruit (AAA)
 - Palpation for area of tenderness and possible related peritoneal signs
 - Further exam as indicated by history

Basic Medical Care

1. [Medical Initial Assessment Protocol](#)
2. Assess vital signs
3. Provide supplemental oxygen per patient condition to maintain $SpO_2 = 94 - 97\%$
4. Provide assisted ventilations with bag-valve mask and 100% oxygen if breathing or ventilatory compromise is apparent
5. Assess blood glucose level
 - A. Administer oral glucose if patient hypoglycemic and alert with intact gag reflex

Advanced Medical Care

1. Obtain 4-lead and refer to appropriate protocol as indicated
2. Obtain 12-lead ECG if patient presentation consistent with potential cardiac etiology
3. IVF bolus for signs of hypotension/dehydration
 - A. Adult: 500 – 1000 ml as per patient condition
 - B. Pediatric: 10 – 20 ml/kg
4. Reassess vital signs following IVF bolus
5. Ondansetron (Zofran®) for nausea/vomiting
 - A. Adult: 4 – 8 mg PO, IV, IM
 - B. Pediatric dose = 0.15 mg/kg PO, IV, IM (maximum 4 mg)
6. Fentanyl for pain control
 - A. Adult:
 - i. 1 – 2 mcg/kg IN (maximum 200 mcg)
 - ii. 0.5 – 1 mcg/kg IV, IM (maximum 100 mcg)
 - iii. May repeat x1 in 15 minutes as indicated (maximum 100 mcg any route)
 - B. Pediatric:
 - i. 0.5 – 1 mcg/kg IV, IM, IN (maximum 100 mcg)
 - ii. Contact Medical Control for repeat dosing
7. Alternate analgesic: nitrous oxide via patient-controlled inhalation
 - A. Contraindicated if there is concern for bowel obstruction

Additional Considerations

- * All women of child-bearing age should be pregnant until proven otherwise
 - Abdominal pain with syncope in female of child-bearing age should be considered an ectopic pregnancy until proven otherwise
- * Patients with undiagnosed cause of pain or possible need for surgery should be NPO
- * Consider cardiac etiology of symptoms especially in patients > 50 years of age, history of diabetes, and/or women with upper abdominal complaints
 - "Indigestion" may be the angina equivalent for myocardial ischemia
- * Older patients with abdominal pain, especially those that are hemodynamically unstable, should be considered critical until proven otherwise
 - Consider abdominal aortic aneurysm (AAA)
 - Age > 50-years
 - Bruit on auscultation
 - Diminished femoral pulses
 - Lower extremity pain
 - Pulsatile intra-abdominal mass
- * Vomiting may be the presenting symptom of serious non-GI tract pathologies, consider:
 - CNS process
 - Diabetic ketoacidosis (DKA)
 - Myocardial ischemia/infarction
 - Poisoning
 - Carbon monoxide
 - Organophosphate
- * Differential diagnosis per pain location (presentations may vary)

Right Upper Quadrant	Epigastric	Left Upper Quadrant
Cholelithiasis/cholecystitis Hepatitis Lower lobe pneumonia	Gastritis / Ulcer disease Pancreatitis Myocardial infarction	Pancreatitis Splenic infarct Lower lobe pneumonia
Right Side/Flank	Mid Abdomen	Left Side/Flank
Pyelonephritis Ureteral calculi	Pancreatitis Small bowel obstruction Abdominal aortic aneurysm	Pyelonephritis Ureteral calculi
Right Lower Quadrant	Suprapubic	Left Lower Quadrant
Appendicitis Ectopic pregnancy Ovarian Cyst/torsion Ureteral calculi PID Testicular torsion	Cystitis Urinary retention Uterine fibroids	Diverticulitis Ectopic pregnancy Ovarian cyst/torsion Ureteral calculi PID Testicular torsion
Diffuse		
Bowel perforation Crohn's disease DKA Mesenteric ischemia Spontaneous bacterial peritonitis		

Allergic Reaction (AM-1/PM-1)

Objective

- * Restore and maintain optimal respiratory and cardiovascular status
- * Limit further exposure to the allergen
- * Limit recurrent symptoms

Introduction

- * True anaphylaxis is a severe systemic reaction to an allergen causing a massive release of histamine and other chemical mediators
- * Although anything can cause anaphylaxis, the most common offenders include:
 - Antibiotics (penicillins, sulfa, vancomycin)
 - Aspirin
 - Bee stings
 - Contrast dye
 - Foods (i.e. peanuts, shellfish)
 - NSAID's
- * Anaphylaxis may cause:
 - Generalized urticaria and pruritus
 - Hypotension due to vasodilatation
 - Respiratory distress due to Bronchospasm
 - Upper airway obstruction due to edema

Clinical Presentation

- * Difficulty breathing, swallowing
- * Exposure to allergen (may not be realized)
- * Hypotension
- * Nausea and vomiting
- * Possible anxiety or agitation
- * Rapidly progressive upper airway edema with stridor, increased secretions, dysphagia
- * Urticaria with or without pruritus
- * Wheezing

Differential Diagnosis

- * Angioedema
- * Aspiration / airway obstruction
- * Asthma / COPD
- * Cardiac dysrhythmia
- * Congestive heart failure
- * Pulmonary embolus
- * Shock

Basic Medical Care

1. [Medical Initial Assessment Protocol](#) or [Pediatric Initial Assessment Protocol](#)
2. Assess vital signs
3. Provide supplemental oxygen per patient condition to maintain SpO₂ = 94 – 97%
4. Attempt to remove source of exposure (e.g. stinger) as possible
5. Epinephrine (1:1000) IM for any evidence of anaphylaxis
 - A. Adult: 0.3 ml
 - i. Consider decreasing dose to 0.15 mg IM in patients with coronary artery disease or patients > 55-years and CAD risk factors
 - B. Pediatric: 0.15 ml
6. Albuterol for associated bronchospasm via hand-held or mask nebulizer:
 - A. Adult: 5 mg
 - i. Repeat 5 mg as indicated by patient's condition
 - B. Pediatric: 2.5 – 5 mg

Repeat 2.5 – 5 mg as indicated by patient's condition
7. Diphenhydramine (Benadryl®) for uncomplicated allergic reaction (urticaria, flushing, itching only)
 - A. Adult: 25 – 50 mg PO
 - B. Pediatric: > 9 months of age: 1 mg/kg PO (maximum 50 mg)

Advanced Medical Care

1. Uncomplicated allergic reaction (urticaria, flushing, itching only)
 - A. Diphenhydramine (Benadryl®); if not already administered
 - i. Adult: 25 – 50 mg PO, IV or IM
 - ii. Pediatric > 9 months of age: 1 mg/kg PO, IV, IM (maximum 50 mg)
 - B. Dexamethasone
 - i. Adult: 16 mg IV, PO
 - ii. Pediatric: 0.6 mg/kg IV, PO (max 16 mg)
2. For any evidence of anaphylaxis
 - A. Epinephrine (1:1,000)
 - i. Adult: 0.3 mg IM
 - Consider decreasing dose to 0.15 mg IM in patients with coronary artery disease or patients > 55-years and CAD risk factors
 - ii. Pediatric: 0.01 mg/kg IM (0.01 ml/kg); maximum 0.3 mg (0.3 ml)
 - iii. May repeat every 5 – 10 minutes depending on patient response
 - B. IVF as indicated
 - i. Adult: wide open
 - ii. Pediatric: 20 ml/kg and reassess, re-bolus as clinically indicated
 - C. Diphenhydramine & dexamethasone as above (if not yet administered)

3. Albuterol for associated bronchospasm via hand-held or mask nebulizer
 - A. Adult: 5 mg
 - B. Pediatric: 2.5 – 5 mg
4. [Airway: Adult](#) or [Airway: Pediatric Protocol](#)
5. Advanced Airway management as indicated
 - A. [Airway: Intubation Protocol](#)
 - B. [Airway: BIAD Protocol](#)
6. Ensure proper tube placement using capnometry, SpO₂ and ventilate with 100% oxygen

Additional Considerations

- * Epinephrine is the drug of choice and the first drug that should be administered in acute anaphylaxis (any Moderate / Severe Symptoms)
 - Epinephrine should be administered in priority before attempts at IV or IO access
- * Anaphylaxis is a clinical diagnosis based on typical systemic manifestations
- * Cardiovascular effects result from decreased vascular tone and capillary leakage
 - Hypotension, cardiac arrhythmias, syncope, and shock can result from intravascular volume loss, vasodilation, and myocardial dysfunction
- * Anaphylaxis symptoms may include
 - Altered mental status
 - Altered voice
 - Difficulty swallowing
 - Hypotension
 - Respiratory distress
 - Sensation of throat swelling
- * Allergic reactions may occur with only respiratory or gastrointestinal symptoms and have no rash / skin involvement
- * Angioedema is seen in moderate to severe reactions and involves swelling of the face, lips or airway structures
 - May be seen in patients taking Angiotensin Converting Enzyme Inhibitors (ACE-I)
 - lisinopril (Prinivil[®], Zestril[®]) benazepril (Lotensin[®]), captopril (Capoten[®])
- * Hereditary Angioedema involves swelling of the face, lips, airway structures, extremities, and may cause moderate to severe abdominal pain
 - Some patients are prescribed specific medications to aid in reversal of swelling
 - Ecallantide (Kalbitor[®])
 - Paramedic may assist or administer this medication per patient's physician or package instructions

Bites & Envenomations (TE-1)

Snake Bite

Introduction

- * Consider bite is poisonous until proven otherwise
- * Typically present with pain, swelling, edema, paresthesia, numbness
- * May present with nausea, vomiting, hypotension, coagulopathy, seizure
- * 25% of bites may be “dry bites” – no envenomation

Basic Medical Care

1. Ensure scene safety
2. Assess vital signs
3. Provide supplemental oxygen per patient condition to maintain SpO₂ = 94 – 97%
4. Obtain any available information about the snake
5. Immobilize extremity in neutral position
 - A. Measure extremity circumference at and above the bite site
 - B. Place appropriate marking on the extremity to ensure subsequent measurements are taken at the same location for direct comparison
6. Remove any constricting clothing or jewelry/watches
7. Provide basic wound care for the bite site
8. Do **NOT** apply ice
9. Do **NOT** apply any constrictive dressings (including any form of tourniquet)
10. Acetaminophen (Tylenol®) for pain control
 - A. Adult: 650 – 975 mg PO
 - B. Pediatric: 15 mg/kg PO (maximum 650 mg)

Advanced Medical Care

1. IVF as per patient condition
 - A. Adult: TKO to wide open
 - B. Pediatric: TKO to 10 – 20 ml/kg bolus and reassess
2. Fentanyl for pain control
 - A. Adult
 - i. 1 – 2 mcg/kg IN (maximum 200 mcg)
 - ii. 0.5 – 1 mcg/kg IV, IM, IO (maximum 100 mcg)
 - iii. May repeat x1 in 15 minutes as indicated (maximum 100 mcg any route)
 - B. Pediatric
 - i. 0.5 – 1 mcg/kg IN, IV, IM (maximum 100 mcg)
 - ii. Contact medical control for repeat dosing

Additional Considerations

- * Contact Poison Control as needed: **800-222-1222**

Marine Envenomation/Injury (TE-6)

Sources

- * Cone shell sting
- * Coral sting
- * Jellyfish sting
- * Lion fish sting
- * Man-o-war
- * Sea anemone
- * Sea urchin sting
- * Sting ray barb

Clinical Presentation

- * Allergic reaction
- * Hypotension
- * Increased oral secretions
- * Localized pain, swelling, edema
- * Nausea / vomiting
- * Paresthesias, numbness

Introduction

- * Allergic reactions/anaphylaxis may occur from marine envenomations
- * Coral contact often presents with delayed onset of symptoms
- * Many marine envenomations occur in the home as above sources are kept as pets in saltwater aquariums

Basic Medical Care

1. Ensure scene safety
2. Provide supplemental oxygen per patient condition to maintain SpO₂ = 94 – 97%
3. Assess bite site / extremity
 - A. Measure extremity circumference at and above bite site
 - B. Place appropriate marking on the extremity to ensure subsequent measurements taken at the same location for direct comparison
 - C. Repeat measurement every 15 minutes until stable
4. [Allergic Reaction Protocol](#) as indicated
5. Remove any obvious barbs/spines/stingers from extremities
 - A. Lift do NOT brush away any tentacles or barbs
6. Rinse site / area with seawater (do **NOT** use fresh water)
 - A. May rinse with vinegar as available (jellyfish, anemone, man-o-war stings)
 - B. Immerse with hot water as available (sting ray, lion fish, sea urchin stings)
 - i. Assure temperature does not cause thermal injury
7. Remove any constricting clothing or jewelry/watches
8. Splint the affected extremity in neutral position
9. Do **NOT** apply ice
10. Do **NOT** apply constrictive dressings (including tourniquet)
11. Acetaminophen (Tylenol®) for pain control
 - A. Adult: 650 – 975 mg PO
 - B. Pediatric: 15 mg/kg PO (maximum 650 mg)

Advanced Medical Care

1. IVF as per patient condition
 - A. Adult: TKO to wide open
 - B. Pediatric: TKO to 10 – 20 ml/kg bolus and reassess
2. Fentanyl for pain control
 - A. Adult
 - i. 1 – 2 mcg/kg IN (maximum 200 mcg)
 - ii. 0.5 – 1 mcg/kg IV, IM (maximum 100 mcg)
 - iii. May repeat x1 in 15 minutes as indicated (maximum 100 mcg any route)
 - B. Pediatrics
 - i. 0.5 – 1 mcg/kg IV, IM, IN (maximum 100 mcg)
 - ii. Contact medical control for repeat dosing
2. Alternative analgesic: nitrous oxide via patient-controlled inhalation
3. Calcium gluconate for severe muscle spasms
 - A. Adult: 1 gram (10 ml of 10% solution) IV, IO
 - B. Pediatric: 20 mg/kg IV, IO (0.2 ml/kg of 10% solution); maximum 2 grams (20ml)

Other Envenomations

- * Fire ants
 - Approximately 10% of patients with fire ant bites will suffer anaphylactic reactions
 - [Allergic Reaction Protocol](#) as indicated
- * Black widow spider bites
 - Can cause significant muscle spasms and pain and therefore may require benzodiazepine administration as well as analgesic care
 - Contact Medical Control for possible midazolam (Versed®) administration
- * Brown recluse spider bites
 - Initially present with minimal symptoms
 - May progress to necrotic bite sites over the next few days

Venomous Snakes in Mecklenburg County*Copperhead**Timber Rattlesnake*

- * Consider patients may have exotic snakes as pets including other venomous species (other rattlesnakes, cobras, coral snakes, etc.)
- * Do not attempt to identify, capture or bring snake to the hospital

Animal Bites (TE-1)

Types

- * Cat bite
- * Dog bite
- * Human bite
- * Insect sting
- * Other animal bites

Basic Medical Care

1. Ensure scene safety
2. [Medical Initial Assessment Protocol](#) or [Pediatric Initial Assessment Protocol](#)
3. [Trauma Initial Assessment Protocol](#) or [Pediatric Trauma Assessment Protocol](#)
4. Control bleeding
5. Assess vital signs
6. Provide supplemental oxygen per patient condition to maintain SpO₂ = 94 – 97%
 - A. Provide local wound care and dress wound as appropriate
7. Copiously irrigate with normal saline
8. Remove any constricting clothing or jewelry/watches
9. Splint affected extremity as needed for patient comfort
10. [Allergic Reaction Protocol](#) as indicated
12. Acetaminophen (Tylenol®) for pain control
 - A. Adult: 650 – 975 mg PO
 - A. Pediatric: 15 mg/kg PO (maximum 650 mg)

Advanced Medical Care

1. IV Access as indicated by mechanism of injury
 - A. Preferably establish IV access in unaffected extremity
 - B. IVF as indicated by patient condition
 - i. Adults: TKO to wide open
 - ii. Pediatrics: TKO to 10 – 20 ml/kg bolus and reassess
2. Fentanyl for pain control
 - B. Adult:
 - i. 1 – 2 mcg/kg IN (maximum 200 mcg)
 - ii. 0.5 – 1 mcg/kg IV, IM, IO (maximum 100 mcg)
 - iii. May repeat x1 in 15 minutes as indicated (maximum 100 mcg any route)
 - C. Pediatric:
 - i. 0.5 – 1 mcg/kg IN, IV, IM, IO (maximum 100 mcg)
 - ii. Contact medical control for repeat dosing
3. Alternative analgesic: nitrous oxide via patient-controlled inhalation
4. [Allergic Reaction Protocol](#) as indicated

5. Advanced Airway management as indicated
 - D. [Airway: Intubation Protocol](#)
 - E. [Airway: BIAD Protocol](#)
6. Ensure proper tube placement using capnometry, SpO₂ and ventilate with 100% oxygen

Additional Considerations

* Human bites

- Control hemorrhage and apply appropriate wound dressing
- Apply appropriate wound dressing
- Potential for high infection rates
 - Eikenella
 - Streptococcus
 - Staphylococcus
- "Fight bite" injuries involve wounds to hands from thrown punches contacting teeth of 2nd party
 - These wounds are particularly at high risk for infection
 - Transport to the ED for irrigation and antibiotics should be recommended if the patient is declining transport

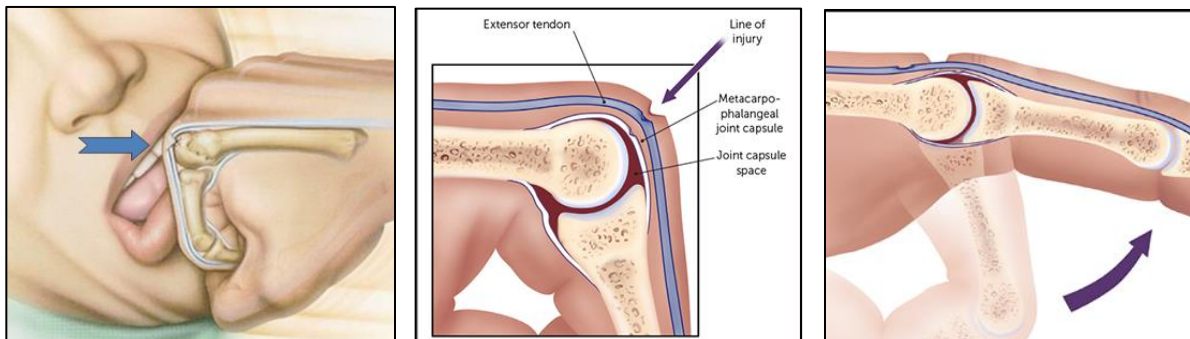

* Dog & Cat bites

- Dog bites often have associated crush type injury
- Cat bites often have deep puncture wounds with minimal surface injury and therefore increased risk of infection
- Potential for high infection rates
 - Dogs: Pasteurella, staphylococcus, streptococcus
 - Cats: Pasteurella, staphylococcus, streptococcus
- Control hemorrhage and apply appropriate wound dressing
- Any unknown animal bite must be considered at risk for rabies transmission
- Contact with Animal Control

Assault

Basic Medical Care

1. Ensure scene safety
 - A. It may be necessary to remove the patient from the surrounding area to a more protective and supportive environment
 - B. After discussing your course of action and within a confidential setting, remove appropriate clothing to fully inspect the chest, abdomen, and extremities for any signs of physical abuse or assault
2. [Trauma Initial Assessment Protocol](#) or [Pediatric Trauma Assessment Protocol](#)
3. Maintain airway
 - A. Provide assisted ventilations with bag-valve mask and 100% oxygen if breathing or ventilatory compromise is apparent
4. [Spinal Motion Restriction Protocol](#) as per patient history and presentation
5. Assess vital signs
6. Provide supplemental oxygen per patient condition to maintain SpO₂ = 94 – 97%
7. Control any active bleeding sites with manual direct pressure and/or pressure dressing
 - A. Apply Medic tourniquet as indicated per [Wound Care Tourniquet Protocol](#)
8. Acetaminophen (Tylenol®) for pain control
 - A. Adult: 650 – 975 mg PO
 - B. Pediatric: 15 mg/kg PO (maximum 650 mg)

Advanced Medical Care

1. IV access as indicated by mechanism of injury and physical exam findings
2. IVF bolus for signs of hypotension
 - A. Adult: 500 – 1000 ml as per patient condition
 - B. Pediatric: 10 – 20 ml/kg
3. Fentanyl for pain control
 - A. Adult:
 - i. 1 – 2 mcg/kg IN (maximum 200 mcg)
 - ii. 0.5 – 1 mcg/kg IV, IM, IO (maximum 100 mcg)
 - iii. May repeat x1 in 15 minutes as indicated (maximum 100 mcg any route)
 - B. Pediatric:
 - i. 0.5 – 1 mcg/kg IV, IM, IN, IO (maximum 100 mcg)
 - ii. Contact Medical Control for repeat dosing
4. Alternate analgesic: nitrous oxide via patient-controlled inhalation
5. For adult with suspected open fracture: cefazolin (Ancef®)
 - A. > 120 kg: 3 grams IV over 3 – 5 minutes
 - B. 40 – 120 kg: 2 grams IV over 3 – 5 minutes
6. Advanced Airway management as indicated
 - A. [Airway: Intubation Protocol](#)
 - B. [Airway: BIAD Protocol](#)
7. Ensure proper tube placement using capnometry, SpO₂ and ventilate with 100% oxygen

Additional Considerations

- * If a sexual assault has occurred, do not allow patient to shower or change clothes
- * Adult assault patients should only refuse care in the presence of law enforcement officers
 - If this is not available, the case should be discussed with Medical Control
 - A Patient Refusal Form will be completed on all cases of refusal
- * Pediatric assault patients may not refuse transport, nor may their guardians refuse transport if you suspect child abuse
- * Refer to Non-fatal strangulation and/or human trafficking protocols as indicated
- * Ensure that patient has a safe place to go if refusing transport (family members, friends) and document this information in the PCR
- * It may be acceptable for patients to agree to go to the hospital but refuse all assessment and care in the field
- * Fentanyl or other mind-altering medications for pain control should be avoided in patients with a closed head injury unless ordered by medical control
- * Ensure contact with DSS & other appropriate agency for cases of suspected elder or child abuse or neglect
 - **Mecklenburg County Department of Social Services** to report the suspicion
 - **(980) 314-3577**
 - **(704) 336-2273**
 - Online Reporting Tool [MeckNC.gov/CPSReportOnline](https://www.mecknc.gov/CPSReportOnline)
- * Report any suspicion of human trafficking to the **National Human Trafficking Resource Center:**
 - Phone: **(888) 373-7888**
 - Text: **233733**

Back Pain (UP-5)

Differential diagnosis

- * Abdominal aortic aneurysm
- * Acute coronary syndrome
- * Aortic dissection
- * Epidural abscess
- * Herniated disc
- * Kidney stone
- * Metastatic cancer
- * Musculoskeletal strain / muscle spasm
- * Pneumonia
- * Pulmonary embolus
- * Pyelonephritis
- * Vertebral disc rupture/herniation
- * Vertebral fracture

Clinical Presentation

- * History considerations
 - Age
 - Onset of pain
 - Trauma
 - Lower extremity symptoms
 - Bowel, bladder, urinary dysfunction symptoms
- * Physical exam
 - Vital signs including temperature
 - Abdominal mass, bruit
 - Costovertebral angle tenderness, muscular tenderness
 - Midline/vertebral tenderness
 - Extremity motor, sensory, vascular status

Basic Medical Care

1. [Medical Initial Assessment Protocol](#) or [Pediatric Initial Assessment Protocol](#)
2. [Trauma Initial Assessment Protocol](#) or [Pediatric Trauma Assessment Protocol](#)
3. Assess vital signs
4. Provide supplemental oxygen per patient condition to maintain SpO₂ = 94 – 97%
5. Medical
 - A. Allow patient to sit/lay in position of comfort
 - B. Additional care as per appropriate medical protocol
6. Trauma
 - A. [Spinal Motion Restriction Protocol](#) as per patient history and presentation
 - i. Long spine boards are to be utilized as a patient extrication/movement device and are not intended for the patient to be transported on the LSB
 - B. Additional care as per appropriate trauma protocol
7. Acetaminophen (Tylenol®) for pain control
 - A. Adult: 650 – 975 mg PO
 - B. Pediatric: 15 mg/kg PO (maximum 650 mg)

Advanced Medical Care

1. Obtain 4-lead ECG and refer to appropriate protocol as indicated
2. 12-lead ECG as per patient's presentation
3. IV Access as indicated by mechanism of injury, patient presentation
4. IVF as indicated for signs of hypotension, volume depletion
 - A. Adult: 500 – 1000 ml as per patient condition
 - B. Pediatric: 10 – 20 ml/kg as per patient condition
 - C. Repeat IVF bolus as indicated per patient condition
5. Fentanyl for pain control
 - A. Adult:
 - i. 1 – 2 mcg/kg IN (maximum 200 mcg)
 - ii. 0.5 – 1 mcg/kg IV, IM, IO (maximum 100 mcg)
 - iii. May repeat x1 in 15 minutes as indicated (maximum 100 mcg any route)
 - B. Pediatric:
 - i. 0.5 – 1 mcg/kg IV, IM, IN, IO (maximum 100 mcg)
 - ii. Contact Medical Control for repeat dosing
 - C. NOT indicated for patients with chronic pain
6. Alternate analgesic: nitrous oxide via patient-controlled inhalation
7. Ondansetron (Zofran®) for nausea/vomiting
 - A. Adult: 4 – 8 mg IV, IM, PO
 - B. Pediatric: 0.15 mg/kg IV, IM, PO (maximum 4 mg)
8. Additional treatment as per appropriate protocol or contact medical control for management assistance

Additional Considerations

- * Analgesia may be required prior to patient movement
- * Elderly patients with back pain, especially those that are hemodynamically unstable, should be considered critical until proven otherwise
- * Back pain in diabetic patients may be cardiac in etiology
- * Women of child-bearing age should be considered pregnant until proven otherwise
 - Pregnancy/ectopic must be considered
- * Potential Etiologies
 - Abdominal aortic aneurysms
 - May present as isolated back pain or abdominal pain radiating to the back
 - May present with pulsatile abdominal mass, bruit and /or diminished lower extremity pulses
 - Aortic dissection
 - Hypertension and thoracic back pain
 - Blood pressure and pulses should be checked in both extremities
 - Cauda equine (compression of spinal cord terminal nerves)
 - May present with saddle anesthesia, bowel/bladder dysfunction, lower extremity motor weakness and decreased reflexes
 - Cholecystitis
 - May present as RUQ pain with radiation to back and/or the scapula
 - Epidural abscess
 - Fever, chills
 - History of IV drug abuse
 - Immunocompromised (HIV, chronic steroids, other)
 - Kidney stones
 - May present as intractable unilateral flank pain that radiates to the groin
 - Sciatica
 - May present as low back pain radiating down posterior aspect of one leg
- * Concerning signs & symptoms ("red flag" symptoms)
 - Age > 50 or < 18-years
 - Fever
 - History of IV drug abuse
 - History of cancer
 - Neurological deficit
 - Bowel incontinence
 - Saddle area anesthesia
 - Urinary retention
 - Weakness
 - Pain worse at rest

Breathing Problems

Differential Diagnosis

Adult

- * Anaphylaxis
- * Aspiration
- * Asthma
- * Cardiac dysrhythmia
- * Congestive heart failure
- * COPD
- * Epiglottitis
- * Myocardial infarction
- * Peritonsillar abscess
- * Pleural effusion
- * Pneumonia
- * Pneumothorax
- * Pulmonary embolus
- * Toxic inhalation
- * Upper respiratory infection
- * Volume overload

Pediatric

- * Anaphylaxis
- * Aspiration
- * Asthma
- * Cardiac dysrhythmia
- * Congenital heart disease
- * Croup
- * Epiglottitis
- * Foreign body airway obstruction
- * Peritonsillar abscess
- * Pneumonia
- * Pneumothorax
- * Retropharyngeal abscess
- * Tonsillitis
- * Toxic inhalation
- * Upper respiratory infection

Evaluation

- * History
 - Pre-existing cardiac or pulmonary disease
 - Acute vs. gradual onset & duration of symptoms
 - Presence of chest pain, fever, and/or cough
 - Past medical history – CHF, COPD, asthma, pulmonary fibrosis, ESRD
 - Social history – tobacco usage, cocaine
- * Physical exam
 - Assess mental status
 - Auscultate heart sounds
 - Auscultate breath sounds
 - Absent breath sounds consider pneumothorax
 - Diffuse rales consider pulmonary edema
 - Focal rales / rhonchi consider pneumonia
 - Diffuse wheezing: consider reactive airway disease
 - Focal diminished sounds: consider pleural effusion, pneumonia
 - Normal sounds with pleuritic chest pain: consider pulmonary embolus
 - Assess for unilateral or bilateral lower extremity edema
 - Assess for urticaria

Basic Medical Care

1. [Medical Initial Assessment Protocol](#) or [Pediatric Initial Assessment Protocol](#)
2. Maintain airway; suction as needed
3. Assess vital signs
4. Provide supplemental oxygen per patient condition to maintain $SpO_2 = 94 - 97\%$
 - A. Provide assisted ventilations with bag-valve mask and 100% oxygen if breathing or ventilatory compromise is apparent
5. Allow all conscious patients to sit in a position of comfort
6. Additional care as per presumptive etiology of breathing problem

Advanced Medical Care

1. Obtain 4-lead ECG and refer to appropriate protocol as indicated
2. Obtain 12-lead ECG for patient history consistent with cardiac ischemia or dysrhythmia
3. [Airway: Adult](#); [Airway: Pediatric Protocol](#)
4. Additional care as per presumed etiology of breathing problem
5. Advanced Airway management as indicated
 - A. [Airway: Intubation Protocol](#)
 - B. [Airway: BIAD Protocol](#)
6. Ensure proper tube placement using capnometry, SpO_2 and ventilate with 100% oxygen
7. Additional care as per presumed etiology of breathing problem

Asthma, COPD, Reactive Airway Disease (AR-4, AR-7)

1. Albuterol
 - A. Adult: 5 mg via hand-held or mask nebulizer
 - i. Repeat 5 mg as indicated by patient's condition
 - B. Pediatric: 2.5 – 5 mg via hand-held or mask nebulizer
 - i. Repeat 2.5 – 5 mg as indicated by patient's condition
2. Dexamethasone
 - A. Adult: 16 mg IV, PO
 - B. Pediatric: 0.6 mg/kg IV, PO (maximum 16 mg)
 - i. May refrain from administering IV if placing IV access strictly for the purpose of administering dexamethasone, as this may further distress the pediatric patient worsening any respiratory distress
3. For persistent or severe respiratory distress:
 - A. Continuous positive airway pressure (CPAP) per [Respiratory: NIPPV Protocol](#)
 - B. Continue albuterol in-line via CPAP as indicated by patient condition
 - C. Magnesium sulfate
 - i. Adult: 2 grams IV over 5 – 10 minutes
 - ii. Pediatric: 25 – 50 mg/kg IV over 5 – 10 minutes
4. For severe respiratory distress:
 - A. Epinephrine (1:1,000)
 - i. Adult: 0.3 – 0.5 mg IM
 - Consider decreasing dose to 0.15 mg IM in patients with coronary artery disease or patients > 55 years and CAD risk factors
 - ii. Pediatric: 0.01 mg/kg IM; maximum 0.3 mg IM (0.3 ml)
5. Advanced Airway management as indicated
 - A. [Airway: Intubation Protocol](#)
 - B. [Airway: BIAD Protocol](#)
6. Ensure proper tube placement with capnometry, SpO₂, ventilate with 100% oxygen
7. Continue albuterol in-line via CPAP, ETT, or BIAD as indicated by patient condition

Pulmonary Edema (AC-5)

Advanced Medical Care

1. Obtain 4-lead ECG and refer to appropriate protocol as indicated
2. Obtain 12-lead ECG as indicated by patient presentation
3. For persistent respiratory distress: Continuous positive airway pressure (CPAP) per [Respiratory: NIPPV Protocol](#)
 - A. Titrate pressure per patient response to therapy
4. Maintain patient in position of respiratory comfort
5. Nitroglycerin (adult patients only)
 - A. 0.4 mg SL
 - B. For patient unable to tolerate SL nitroglycerin, apply nitro paste to upper chest
 - i. SBP > 200 mm Hg: apply 2 inches
 - ii. SBP 150 – 200 mm Hg: apply 1.5 inches
 - iii. SBP 100 – 150 mm Hg: apply 1 inch
 - C. Hold/remove for SBP < 100 mm Hg
 - D. Hold for Viagra®, Cialis®, Levitra®, or similar drug use in the past 24 hours
 - E. EMT may administer to patients with a current prescription for nitroglycerin
6. For hypotension:
 - A. Dopamine @ 10 – 20 mcg/kg/min
7. Advanced Airway management as indicated
 - A. [Airway: Intubation Protocol](#)
 - B. [Airway: BIAD Protocol](#)
8. Ensure proper tube placement using capnometry and SpO₂, ventilate with 100% oxygen

Additional Considerations

- * Patients with respiratory distress and elevated blood pressure
 - Assess patient to determine if the elevated blood pressure is the cause of the respiratory distress (e.g. CHF)
 - If true, treat blood pressure as part of managing the respiratory distress
 - Assess patient to determine if the elevated blood pressure is a result of the respiratory distress (e.g. COPD or asthma exacerbation)
 - If true, aggressively treat the respiratory distress per protocol
 - The blood pressure does not require direct treatment

Croup (AR-7)

Description

- * Acute obstructive swelling and inflammation in the subglottic area and tracheobronchial tree caused by viral infection
- * Occurs most often in children three (3) months to three (3) years of age
- * Often preceded by upper respiratory infection
- * Clinical Presentation: dyspnea, stridor, barking type cough, tachycardia

Basic Medical Care

1. Provide supplemental oxygen per patient condition to maintain SpO₂ = 94 – 97%
2. Maintain child in position of respiratory comfort

Advanced Medical Care

1. For signs of respiratory distress (retractions, flaring, stridor, hypoxia, dyspnea etc.): racemic epinephrine nebulizer
 - A. <5 kg: 0.25 ml (1/2 ampule) of 2.25% solution (diluted to 3 mL with NS)
 - B. ≥5 kg: 0.5 ml (1 ampule) of 2.25% solution (diluted to 3 mL with NS)
2. Dexamethasone 0.6 mg/kg IV, PO (maximum 16 mg)
 - A. Do not start IV access simply for dexamethasone administration – this may further upset the child worsening respiratory distress
3. Reassess patient frequently
4. Advanced airway management as indicated

Bronchiolitis

Description

- * Viral infection typically affecting young infants resulting in fever, congestion, wheezing
- * May cause episodes of apnea

Basic Medical Care

1. Provide supplemental oxygen per patient condition to maintain SpO₂ = 94 – 97%
2. Maintain child in position of respiratory comfort
3. Albuterol 2.5 – 5 mg via hand-held or mask nebulizer
 - A. Repeat 2.5 – 5 mg as indicated by patient's condition

Advanced Medical Care

1. Albuterol 2.5 – 5 mg via hand-held or mask nebulizer
 - A. Repeat 2.5 – 5 mg as indicated by patient's condition

Post-Intubation / BIAD Management (AR-8)

Introduction

- * To be utilized following placement of an endotracheal tube or BIAD

Advanced Medical Care

1. Ensure continuous waveform ETCO₂ monitoring
 - A. Unless patient with an indication for elevated ventilation rates (severe metabolic acidosis – DKA, aspirin overdose, etc.) maintain ETCO₂ 35-45 mmHg
2. Ensure continuous SpO₂ monitoring
3. To improve device tolerance, optimization of ventilation
 - A. Midazolam (Versed®)
 - i. Adult: 5 mg IV, IO, IM
 - ii. Pediatric: 0.15 mg/kg IV, IO, IM (max 5 mg)
 - B. Fentanyl for pain control
 - i. Adult: 50 mcg IV, IO, IM
 - ii. Pediatric: 0.5 mcg/kg IV, IO, IM (maximum 50 mcg)
 - C. Contact medical control for repeat dosing

Additional Considerations

- * For patient comfort remember midazolam (Versed®) does not treat pain

Ventilator Emergencies (AR-9)

Differential Diagnosis

- * Disruption from oxygen source
- * Dislodgement or obstruction of tracheostomy (endotracheal) tube
- * Disruption of ventilator circuit
- * Patient with increase oxygen requirement
- * Ventilator failure

Basic Medical Care

1. Assess vital signs including pulse oximetry
2. Confirm baseline SpO₂ saturation
3. Provide suctioning as indicated per patient condition

Advanced Medical Care

1. Assess ventilator, oxygen source, and circuit
2. Attempt to maintain patient on patient's typical ventilator settings
3. Contact Medical Control to attempt corrective actions to improve cause of respiratory distress/increased work of breathing
 - A. Family may be able to provide instructions from patient's physician
4. Ventilate with bag-valve-device if unable to oxygenate/ventilate with ventilator despite appropriate adjustment to settings
5. Utilize continuous waveform ETCO₂ during transport

Additional Considerations

- * Troubleshooting **DOPE** mnemonic
 - **D**isplaced ETT, tracheostomy
 - **O**bstruction, **O**xygen source
 - **P**neumothorax
 - **E**quipment failure
- * Typical alarms
 - Low pressure/apnea
 - Loose or disconnected circuit
 - Leak in circuit or at tracheostomy site
 - Low power
 - Internal battery depletion
 - High pressure
 - Plugged/obstructed airway or circuit
- * When in doubt: ventilate with bag-valve-device if unable to oxygenate/ventilate with ventilator

Additional Considerations

- * CPAP
 - For COPD, asthma, bronchospasm, or reactive airways disease, apply positive end-expiratory pressure by starting at 3 – 5 cm H₂O of pressure and slowly titrating to achieve a desirable and tolerated positive pressure reading
 - Maximum 10 cm H₂O
- * The benefits of administering supplemental oxygen to patients with exacerbated COPD outweigh the risks of suppressing the hypoxic respiratory drive
 - This phenomenon does not occur in the acute care or prehospital setting
- * Bronchospasm may be severe enough – especially in pediatric patients – that no wheezing is heard on auscultation as air flow is minimal
 - This represents significant exacerbation and warrants aggressive therapy
- * When patients present with severe respiratory distress, impending respiratory failure or are deteriorating, treatment should be initiated before transport
- * Consider the patient's history of or risk for coronary artery disease prior to the administration of epinephrine
 - Consider decreasing dose or contact medical control prior to IM epinephrine administration to patients with a known cardiac history or patients > 55-years of age with known coronary artery disease risk factors
 - However, there is no contraindication to the administration of epinephrine in a life-threatening respiratory situation
- * For intubated patients:
 - Allow for adequate time for exhalation with increased I:E ratios
 - Plan for lower respiratory rates and lower tidal volumes than typical normal levels in patients with asthma/COPD exacerbations
 - Goal of treatment is to maximize medical therapy early to avoid intubation
- * Consider acute myocardial ischemic event, especially in patients with any chest pain or cardiac disease risk factors
- * Epiglottitis
 - Bacterial infection involving the epiglottis causing it to swell and partially or totally obstruct the upper airway
 - Typically presents with sudden onset of sore throat, drooling, stridor, and fever
 - Total airway occlusion is a catastrophic possibility that can be precipitated by invasive oral exams (using tongue blades or laryngoscopes), finger sweeps, and/or supine positioning
 - Prehospital treatment includes quiet transportation with the patient in position of comfort and parent or guardian accompanying the child
 - Oxygen should be utilized as tolerated

Tracheostomy Tube Emergencies (AR-10)

Differential Diagnosis

- * Allergic reaction
- * Aspiration
- * Asthma
- * Foreign body obstruction
- * Infection / Sepsis
- * Trauma
- * Ventilator failure

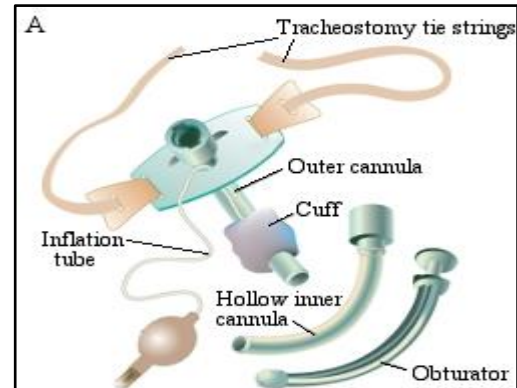

Basic Medical Care

1. Assess vital signs
2. Provide supplemental oxygen per patient condition to maintain $SpO_2 = 94 - 97\%$
3. Provide suctioning as indicated per patient condition
4. Maintain patient in position of respiratory comfort
5. Assist ventilations with BVM as indicated per patient condition

Advanced Medical Care

1. Assess tracheostomy tube
2. For tube not in place; place tube via standard technique
 - A. Prepare and check necessary equipment including device of the same size and 0.5 size smaller than patients existing device
 - B. Have standard airway management equipment available
 - C. Appropriately lubricate the replacement tube
3. Ensure obturator removed following tracheostomy tube insertion
4. Ensure inner cannula properly placed
5. Provide suctioning as indicated per patient condition
 - A. Limit suctioning attempt to < 10 seconds
 - B. May instill 2 – 3 ml of saline as needed before suctioning
6. Replace tube if indicated per [Airway: Tracheostomy Tube Change Protocol](#)
7. If unable to place new smaller device, use standard airway procedures to assist patient
 - A. [Airway: Adult Protocol](#); [Airway: Pediatric Protocol](#)

Additional Considerations

- * Utilize family members as appropriate for assistance in the care of the tracheostomy
- * Anticipate more difficult tube changing with tracheostomies < 2-weeks old
- * Potential complications
 - Airway obstruction
 - Airway device misplacement
 - Bleeding

Burns

Clinical Presentation

- * Superficial burns
 - Erythematous patches
 - Minimal tissue injury of the outermost layers of epidermis
- * Partial thickness burns
 - Vesicle formation
 - Tissue damage extends into dermis
- * Full thickness burns
 - Charred, leathery or pearly white surface
 - Destruction of all layers of skin including nerve endings
- * Rule of nines for estimation of % total body surface area – **Adult**
 - Head = 9% (face 4.5%, scalp 4.5%)
 - Anterior torso = 18%
 - Posterior torso = 18%
 - R Arm = 9% (anterior 4.5%, posterior 4.5%)
 - L Arm = 9% (anterior 4.5%, posterior 4.5%)
 - R Leg = 18% (anterior 9%, posterior 9%)
 - L Leg = 18% (anterior 9%, posterior 9%)
 - Genitalia = 1%
- * Rule of nines for estimations of % total body surface area – **Pediatric**
 - Head = 18% (face 9%, scalp 9%)
 - Chest = 13%
 - Back = 13%
 - R Arm = 9%
 - L Arm = 9%
 - R Leg = 18%
 - L Leg = 18%
 - Genitalia = 1%
- * ***Only partial-thickness (2nd degree) and full-thickness (3rd degree) burns should be considered when calculating the Total Body Surface Area (TBSA) extent of burns***
 - As an estimate, the size of the patient's palm can be considered 1% TBSA in calculating scattered areas of burn
 - Refer to attached figures for further assistance in calculating TBSA extent of burn
- * TBSA estimation of burn size can only be utilized for thermal burns
- * For electrical burns: exterior burns CANNOT be utilized to determine extent of injury or needed fluid resuscitation

Burns – Thermal (TB-9)

Basic Medical Care

1. Ensure scene safety
2. Remove patient from source of injury
3. [Trauma Initial Assessment Protocol](#) or [Pediatric Trauma Assessment Protocol](#)
4. [Airway: Adult Protocol](#); [Airway: Pediatric Protocol](#)
5. Assess vital signs
6. Provide supplemental oxygen per patient condition to maintain SpO₂ = 94 – 97%
7. Assess extent and depth of burns
8. Assess for signs of airway burns / inhalational injury
 - A. Carbonaceous sputum
 - B. Intra-oral burns
 - C. Singed nasal hair
 - D. Stridor, dyspnea
9. For multi-trauma [Spinal Motion Restriction Protocol](#) as per patient history
10. Remove any constricting clothing, jewelry, watches, etc. on any affected extremity
11. Attempt to cool burn with saline or clean water (only if < 1 – 2 minutes from injury)
12. Dress burns with clean, DRY dressings

Advanced Medical Care

1. Apply cardiac monitor
2. [Airway: Adult Protocol](#); [Airway: Pediatric Protocol](#)
3. IVF as indicated per patient condition
 - A. Adult
 - i. Hemodynamically unstable or \geq 25% TBSA: IVF wide open
 - ii. Hemodynamically stable & < 25% TBSA: IVF @ maintenance rate
 - B. Pediatrics
 - i. Hemodynamically unstable or \geq 25% TBSA: IVF @ 20 ml/kg bolus
 - ii. Hemodynamically stable and < 25% TBSA: IVF @ maintenance rate
4. Fentanyl for pain control
 - A. Adult
 - i. 1 – 2 mcg/kg IN (maximum 200 mcg)
 - ii. 0.5 – 1 mcg/kg IV, IM, IO (maximum 100 mcg)
 - iii. May repeat x1 in 15 minutes as indicated (maximum 100 mcg any route)
 - B. Pediatric
 - i. 0.5 – 1 mcg/kg IN, IV, IM (maximum 100 mcg)
 - ii. Contact medical control for repeat dosing
5. Alternative analgesic: Nitrous oxide via patient-controlled inhalation
6. Advanced Airway management as indicated
 - A. [Airway: Intubation Protocol](#)
 - B. [Airway: BIAD Protocol](#)
7. Ensure proper tube placement using capnometry, SpO₂ and ventilate with 100% oxygen

Additional Considerations

- * Always ensure that the scene is safe before approaching the patient
- * Cooling with water is considered useless and potentiates hypothermia if performed beyond the first 1 – 2 minutes from time of exposure
- * Do **NOT** apply ice
- * Carbon monoxide, cyanide, or other toxic gases may exacerbate the patient's clinical condition
 - Consider associated carbon monoxide toxicity
 - High flow oxygen via face mask
 - Consider associated cyanide toxicity
 - Symptoms
 - Altered mental status
 - Chest pain
 - Dizziness
 - Headache
 - Nausea, vomiting
 - Syncope
 - High flow oxygenation is paramount for these patients
 - Pulse oximetry measurements may be falsely elevated
 - Treatment: sodium thiosulfate
 - Adults: 12.5 grams IV over 10 minutes
 - Pediatrics: 250 mg/kg IV (maximum 12.5 grams) over 10 minutes
- * Always consider the possibility of abuse, particularly in pediatric patients
- * It is acceptable to initiate an IV or IO over a superficial or partial thickness burn area
- * Avoid IM medications in patients with significant thermal burns

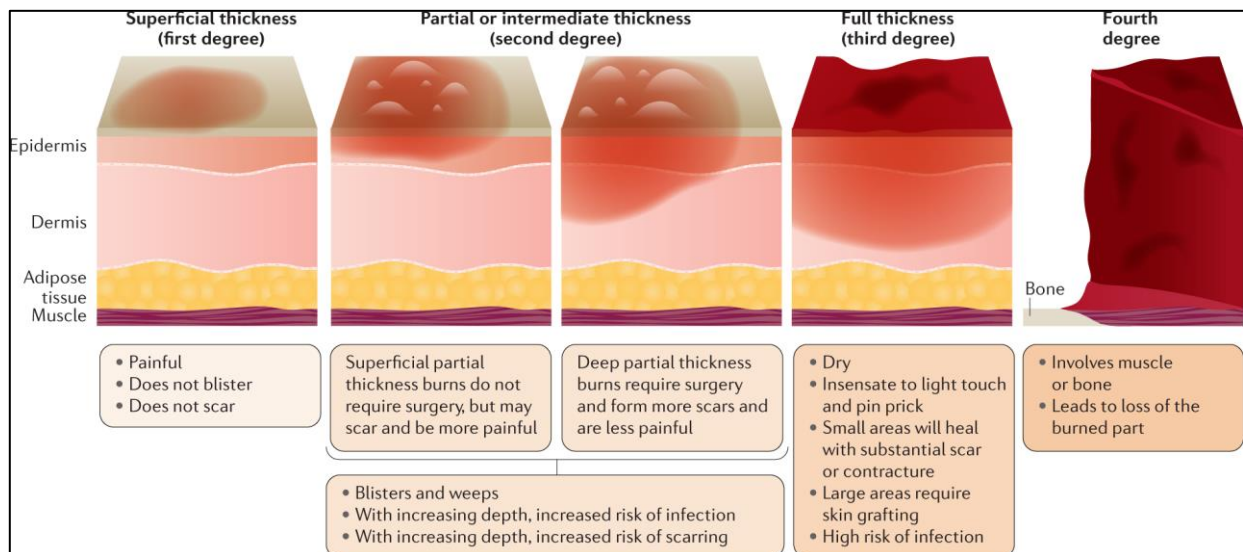

Burns – Chemical and Electrical (TB-2)

Current

- * Alternating Current (AC)
 - Lower voltage, household current
 - Flow of electrons switches from positive to negative
 - Tends to cause continuous muscle contraction (tetany), longer exposure time
 - Classically cardiac arrest due to ventricular fibrillation
- * Direct Current (DC)
 - Higher voltage, power lines, lightning
 - Flow of electrons in one direction
 - Tends to cause single muscle spasm, shorter exposure time and “throw” victim from source
 - Classically cardiac arrest due to asystole

Clinical Presentation

- * Variable entrance and exit wounds
- * Cardiac dysrhythmia
- * Muscle pain

Basic Medical Care

1. Ensure scene safety
 - A. Ensure patient no longer in contact with power source
 - B. Ensure power source turned off
2. [Trauma Initial Assessment Protocol](#) or [Pediatric Trauma Assessment Protocol](#)
3. [Airway: Adult Protocol](#); [Airway: Pediatric Protocol](#)
4. Assess vital signs
5. Initiate spinal motion restriction as indicated
6. Provide copious water / saline irrigation to the site of any chemical burn / exposure after brushing away any dry compounds that may be present
7. Apply sterile dressing to involved site(s)
8. Remove any constricting clothing, jewelry, watches, etc. on any affected extremity
9. Provide supplemental oxygen per patient condition to maintain SpO₂ = 94 – 97%
10. Assess extent and depth of burns
 - A. Rule of nines **CANNOT** be utilized to assess extent of injury with electrical burns
11. Consider blunt trauma as suggested by mechanism of injury
12. Note neurovascular status of distal extremities
13. If chemicals are involved, attempt to identify source
 - A. Any chemical information or copy of the data sheet (MSDS) should be brought to the hospital with the patient
 - B. Decontaminate as indicated based on exposure history
 - C. Copiously irrigate any eye exposure with sterile saline

Advanced Medical Care

1. Obtain 4-lead ECG and refer to appropriate protocol as indicated
2. Obtain 12-lead ECG as per patient history on all patients with electrical injury
3. [Airway: Adult Protocol](#); [Airway: Pediatric Protocol](#)
4. IVF as indicated per patient condition
 - A. Adult
 - i. Hemodynamically unstable: IVF wide open
 - ii. Hemodynamically stable: maintenance rate
 - B. Pediatrics
 - i. Hemodynamically unstable: IVF @ 20 mg/kg bolus
 - ii. Hemodynamically stable: maintenance rate
5. Fentanyl for pain control
 - A. Adult
 - i. 1 – 2 mcg/kg IN (maximum 200 mcg)
 - ii. 0.5 – 1 mcg/kg IV, IM, IO (maximum 100 mcg)
 - iii. May repeat x1 in 15 minutes as indicated (maximum 100 mcg any route)
 - B. Pediatric
 - i. 0.5 – 1 mcg/kg IN, IV, IM (maximum 100 mcg)
 - ii. Contact medical control for repeat dosing
6. Alternative analgesic: nitrous oxide via patient-controlled inhalation
7. Advanced Airway management as indicated
 - A. [Airway: Intubation Protocol](#)
 - B. [Airway: BIAD Protocol](#)
8. Ensure proper tube placement using capnometry, SpO₂ and ventilate with 100% oxygen

Additional Considerations

- * Always ensure that the scene is safe before approaching the patient
- * Carbon monoxide, cyanide, or other toxic gases may exacerbate the patient's condition
 - Consider associated carbon monoxide toxicity
 - High flow oxygen via face mask
 - Consider associated cyanide toxicity
 - Patient may complain of headache, nausea, vomiting, chest pain, dizziness, altered mental status, or a syncopal event
 - High flow oxygenation is paramount for these patients
 - Pulse oximetry measurements may be falsely elevated
 - Treatment: sodium thiosulfate
 - Adults: 12.5 grams IV over 10 minutes
 - Pediatrics: 250 mg/kg IV (maximum 12.5 grams) over 10 minutes
- * Always consider the possibility of abuse, particularly in pediatric or elderly patients
- * It is acceptable to initiate an IV or IO over a superficial or partial thickness burn area

Burn Charts for Estimating Burn Size (Rule of Nines Charts)

Estimation of burn size (Adult)

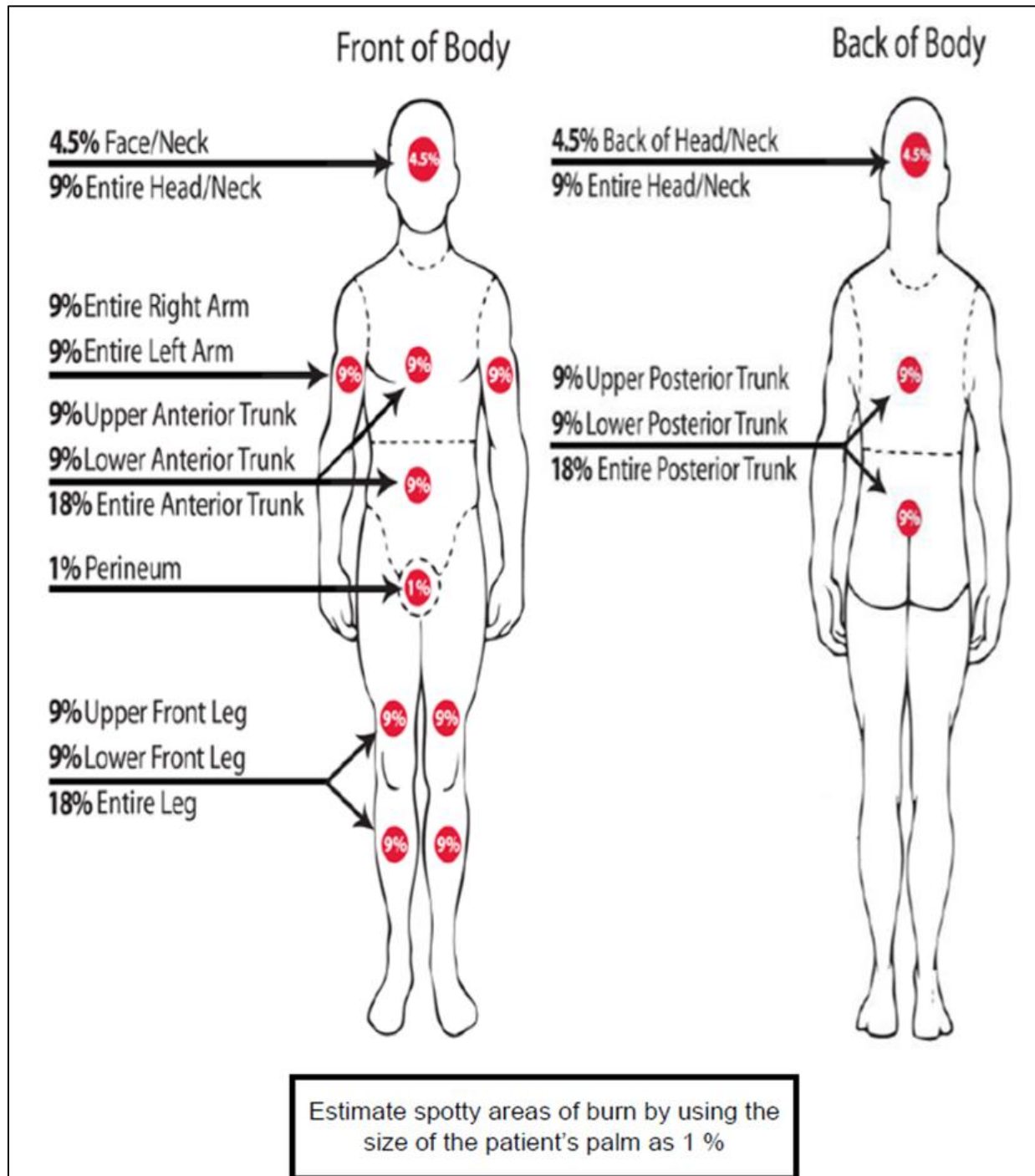

Estimation of burn size (pediatric)

A

Rule of Nines

- Seldom do you find a complete isolated body part that is injured as described in the Rule of Nines.
- More likely, it will be portions of one area, portions of another, and an approximation will be needed.
- For the purpose of determining the extent of serious injury, differentiate the area with minimal or 1st degree burn from those of partial (2nd) or full (3rd) thickness burns.
- For the purpose of determining Total Body Surface Area (TBSA) of burn, include only Partial and Full Thickness burns. Report the observation of other superficial (1st degree) burns but do not include those burns in your TBSA estimate.
- Some texts will refer to 4th 5th and 6th degree burns. There is significant debate regarding the actual value of identifying a burn injury beyond that of the superficial, partial and full thickness burn at least at the level of emergent and primary care. For our work, all are included in Full Thickness burns.
- Other burn classifications in general include:
 - 4th referring to a burn that destroys the dermis and involves muscle tissue.
 - 5th referring to a burn that destroys dermis, penetrates muscle tissue, and involves tissue around the bone.
 - 6th referring to a burn that destroys dermis, destroys muscle tissue, and penetrates or destroys bone tissue.

B

Anterior Posterior

Relative percentage of body surface area (% BSA) affected by growth

Body Part	Age				
	0 yr	1 yr	5 yr	10 yr	15 yr
a = 1/2 of head	9 1/2	8 1/2	6 1/2	5 1/2	4 1/2
b = 1/2 of 1 thigh	2 3/4	3 1/4	4	4 1/4	4 1/2
c = 1/2 of 1 lower leg	2 1/2	2 1/2	2 3/4	3	3 1/4

Estimate spotty areas of burn by using the size of the patient's palm as 1 %

Carbon Monoxide / Cyanide / Hazmat Exposure (TE-2)

History

- * Carbon Monoxide
 - Confined space fire exposure
 - Gas powered home appliances exposure
 - Gas powered machinery exposure
 - Smoke inhalation
- * Cyanide
 - Smoke inhalation
 - Industrial exposure

Considerations

- * Accidental/intentional exposure
- * Duration of exposure
- * Past medical history
- * Pregnancy

Signs & Symptoms

- * Altered mental status
- * Chest pain
- * Confusion
- * Dizziness
- * Dyspnea
- * Headache
- * Malaise, weakness, flu-like illness symptoms
- * Nausea
- * Seizure
- * Syncope

Differential Diagnosis

- * Anaphylaxis
- * Cardiogenic syncope
- * Co-ingestant/exposure
- * Epilepsy
- * Hypo/hyperglycemia
- * Myocardial ischemia/infarction
- * Trauma/head injury
- * Viral infection

Basic Medical Care

1. Ensure scene safety and a protective environment for all personnel and patients
 - A. Consider additional precautions (distance and shielding) when radiological agents are involved
2. Ensure fire department resources (Hazardous Materials Team) has been notified
3. Attempt to identify exposure (bystander or worker information, incident location, environmental indicators, container description, placards or labels, shipping papers or Material Safety Data Sheets, patient symptoms)
4. Don appropriate personal protective equipment
 - A. Decision for type and level will be made by the scene Incident Command
5. Immediately remove all patients from the exposure and determine the level of contamination present
 - A. Determine the need for decontamination prior to full assessment and treatment
 - B. Vapor material source: remove from source of contamination
 - C. Liquid material source: remove contaminated equipment and clothing and perform gross and technical decontamination procedures
 - D. Solid material source: remove material by physical measures of brushing away source, then gross and technical decontamination procedures as indicated
6. [Medical Initial Assessment Protocol](#) or [Pediatric Initial Assessment Protocol](#)
7. [Airway: Adult Protocol](#); [Airway: Pediatric Protocol](#)
8. Assess vital signs
9. Provide supplemental oxygen per patient condition to maintain SpO₂ = 94 – 97%
10. Remove appropriate clothing to fully inspect the chest, abdomen, and extremities for any significant thermal injuries
11. Remove constricting jewelry, watches, etc.
12. If available, utilize a Rad 57 to obtain carboxyhemoglobin level

<ol style="list-style-type: none"> A. <u>Initial SpCO level</u> <ol style="list-style-type: none"> i. < 3% ii. 3% to 12% and no symptoms iii. > 3% and symptoms; or > 12% B. Symptoms of CO toxicity: <ol style="list-style-type: none"> i. Headache, vertigo, confusion, loss of consciousness ii. Shortness of breath iii. Nausea 	<table border="0"> <tr> <td style="text-align: right;"><u>Protocol</u></td> <td></td> </tr> <tr> <td style="text-align: right;">i.</td> <td>Continue to monitor</td> </tr> <tr> <td style="text-align: right;">ii.</td> <td>Oxygen via NRB mask</td> </tr> <tr> <td style="text-align: right;">iii.</td> <td>Oxygen via NRB & transport</td> </tr> </table>	<u>Protocol</u>		i.	Continue to monitor	ii.	Oxygen via NRB mask	iii.	Oxygen via NRB & transport
<u>Protocol</u>									
i.	Continue to monitor								
ii.	Oxygen via NRB mask								
iii.	Oxygen via NRB & transport								
13. For eye exposure, copiously irrigate with sterile saline
14. Provide copious water / saline irrigation to the any site of liquid chemical exposure burn
15. Dry/powder chemical should be brushed-off
 - A. Brushing away from potential inhalation of substance
16. Apply sterile dressing to involved site(s)
17. Any chemical information or copy of the data sheet (MSDS) should be brought to the hospital with the patient

Advanced Medical Care

1. Obtain 4-lead ECG and refer to appropriate protocol as indicated
2. Obtain 12-lead ECG as per patient history
3. [Airway: Adult Protocol](#); [Airway: Pediatric Protocol](#)
4. IVF as indicated per patient condition
 - A. Adult
 - i. Hemodynamically unstable: IVF wide open
 - ii. Hemodynamically stable: IVF @ TKO
 - B. Pediatrics
 - i. Hemodynamically unstable: IVF @ 20 mg/kg bolus
 - ii. Hemodynamically stable: IVF @ TKO
1. Albuterol via hand-held or mask nebulizer as per patient condition
 - A. Adults: 5 mg
 - B. Pediatrics: 2.5 – 5 mg
5. CPAP as indicated by patient condition per [Respiratory: NIPPV Protocol](#)
6. Ondansetron (Zofran®) for nausea/vomiting
 - A. Adults: 4 – 8 mg IV, IM, PO
 - B. Pediatrics: 0.15 mg/kg IV, IM, PO (maximum 4 mg)
7. Advanced Airway management as indicated
 - A. [Airway: Intubation Protocol](#)
 - B. [Airway: BIAD Protocol](#)
8. Ensure proper tube placement using capnometry, SpO₂ and ventilate with 100% oxygen
9. Consider affiliated treatment for cyanide toxicity as indicated per patient presentation

Additional Considerations

- * Carbon Monoxide ½ life
 - Room air = 4 – 6 hours
 - Face mask O₂ @ 15 LPM = 90 minutes
- * Contact Poison Control as needed
 - **800-222-1222**

Cyanide (TE 2)

Toxicity

- * Mild – no symptoms
- * Moderate – anxiety, nausea/vomiting, weakness, dizziness
- * Severe – syncope, loss of consciousness, seizures, apnea

Basic Medical Care

1. Assess vital signs
2. Provide supplemental oxygen
 - A. High flow oxygenation is paramount for these patients
 - B. Pulse oximetry measurements may be falsely elevated
3. Assist ventilations as indicated by patient presentation
4. Assess blood glucose level for any altered mental status

Advanced Medical Care

1. [Airway: Adult Protocol](#); [Airway: Pediatric Protocol](#)
2. IVF as indicated by patient condition
 - A. Adult
 - i. Hemodynamically unstable: IVF wide open
 - ii. Hemodynamically stable: maintenance rate
 - B. Pediatrics
 - i. Hemodynamically unstable: IVF @ 20 mg/kg bolus
 - ii. Hemodynamically stable: maintenance rate
3. Sodium thiosulfate:
 - A. Adults 12.5 grams IV over 10 minutes
 - B. Pediatrics: 250 mg/kg IV (maximum 12.5 grams) over 10 minutes

Additional Considerations

- * Always ensure scene safety
- * Always ensure appropriate personal protection
- * Copiously irrigate exposed patient to prevent cross contamination of providers or other patients
 - Protect patient from hypothermia as a result of irrigation

Vesicants

Agents

- * Mustard gas

Symptoms

- * Skin - erythema, burning, itching, vesicles, blisters, bulla
- * Eyes - conjunctivitis, lid inflammation and edema, blepharospasm, corneal effects
- * Respiratory - epistaxis, sinus pain, pharyngitis, cough, dyspnea, pulmonary edema
- * Other system effects - gastrointestinal tract (nausea, vomiting)

Basic Medical Care

1. Ensure scene safety
2. Skin exposure
 - A. Standard burn therapy
3. Eye exposure
 - A. Copious irrigation
4. Respiratory tract exposure
 - A. Provide supplemental oxygen per patient condition to maintain SpO₂ = 94 – 97%
 - B. Albuterol via hand held or mask nebulizer as indicated
 - i. Adults: 5 mg
 - ii. Pediatric 2.5 – 5 mg
5. Acetaminophen (Tylenol®) for pain control
 - A. Adult: 650 – 975 mg PO
 - B. Pediatric: 15 mg/kg PO (maximum 650 mg)

Advanced Medical Care

1. Additional care as per appropriate medical or trauma condition protocol
2. Fentanyl for pain control
 - A. Adult
 - i. 1 – 2 mcg/kg IN (maximum 200 mcg)
 - ii. 0.5 – 1 mcg/kg IV, IM, IO (maximum 100 mcg)
 - iii. May repeat x1 in 15 minutes as indicated (maximum 100 mcg any route)
 - B. Pediatric
 - i. 0.5 – 1 mcg/kg IN, IV, IM (maximum 100 mcg)

Additional Considerations

- * Copiously irrigate exposed patient to prevent cross contamination of providers or other patients (protect patient from hypothermia as a result of irrigation)

Pulmonary agents

Agents

- * Hydrogen sulfide
- * Ammonia
- * Chlorine

Symptoms

- * Eyes - irritation and burning
- * Respiratory - cough, shortness of breath, dyspnea, chest pain

Basic Medical Care

1. Skin exposure
 - A. Irrigation and standard burn therapy
2. Eye exposure
 - A. Copious irrigation
3. Respiratory tract exposure
 - A. Provide supplemental oxygen per patient condition to maintain SpO₂ = 94 – 97%
 - B. Suction as indicated
 - C. Albuterol via hand held or mask nebulizer as indicated
 - i. Adults: 5 mg
 - ii. Pediatric 2.5 – 5 mg

Advanced Medical Care

1. Additional care as per appropriate medical or trauma condition protocol
2. Fentanyl for pain control
 - A. Adult
 - i. 1 – 2 mcg/kg IN (maximum 200 mcg)
 - ii. 0.5 – 1 mcg/kg IV, IM, IO (maximum 100 mcg)
 - iii. May repeat x1 in 15 minutes as indicated (maximum 100 mcg any route)
 - B. Pediatric
 - i. 0.5 – 1 mcg/kg IN, IV, IM (maximum 100 mcg)

Additional Considerations

- * Always ensure scene safety
- * Always ensure appropriate personal protection
- * Copiously irrigate exposed patient to prevent cross contamination of providers or other patients
 - Protect patient from hypothermia as a result of irrigation

Riot Control Agents

Agents

- * Pepper spray – OC (Oleoresin Capsicum)
- * Mace – CN (chloroacetophenone)
- * Tear gas – CS (chlorobenzylidenemalononitrile)

Symptoms

- * Skin - burning, redness, blisters
- * Eyes - blepharospasm (eyelid closure), transient blindness, tearing, conjunctival injection
- * Respiratory - nasal discharge, sneezing, burning, cough, shortness of breath, chest tightness, bronchospasm and wheezing

Basic Medical Care

1. Skin exposure
 - A. Irrigation and standard burn therapy
2. Eye exposure
 - A. Copious irrigation with normal saline or water
3. Respiratory tract exposure
 - A. Provide supplemental oxygen per patient condition to maintain SpO₂ = 94 – 97%
 - B. Suction as indicated
 - C. Albuterol via hand held or mask nebulizer as indicated
 - i. Adults: 5 mg
 - ii. Pediatric 2.5 – 5 mg
4. Acetaminophen (Tylenol®) for pain control
 - A. Adult: 650 – 975 mg PO
 - B. Pediatric: 15 mg/kg PO (maximum 650 mg)

Advanced Medical Care

1. Additional care as per appropriate medical or trauma condition protocol

Additional Considerations

- * Always ensure scene safety
- * Always ensure appropriate personal protection
- * Copiously irrigate exposed patient to prevent cross contamination of providers or other patients
 - Protect patient from hypothermia as a result of irrigation

WMD - Nerve Agent Exposure (TE-8)

Chemical Nerve Agents, Organophosphates, Carbamates

Symptoms

- * SLUDGE syndrome: salivation, lacrimation, urination, defecations, gastric hypermobility (diarrhea), vomiting
- * Muscle fasciculations, muscle twitching, weakness, flaccid paralysis
- * Loss of consciousness, seizures
- * Hypertension, bradycardia or tachycardia, ventricular dysrhythmias, apnea
- * Vapor exposure: miosis, blurred vision, eye pain

Basic Medical Care

1. Initiate decontamination procedures
2. Airway protection; may need frequent suctioning
3. Provide supplemental oxygen per patient condition to maintain SpO₂ = 94 – 97%
4. Treatment Adult:
 - A. Mild effects (miosis, rhinorrhea, nausea, vomiting)
 - i. 1 – atropine/2-Pralidoxime IM via auto-injector
 - B. Moderate effects (shortness of breath)
 - i. 2 – atropine/2-Pralidoxime IM via auto-injector
 - C. Severe effects (seizures, vomiting, apnea)
 - i. 3 – atropine/2-Pralidoxime IM via auto-injector
5. Treatment Pediatric:
 - A. < 7 years of age: 1 – atropine/2-Pralidoxime IM via auto-injector
 - B. 7 – 14 years of age: 2 – atropine/2-Pralidoxime IM via auto-injector
 - C. > 14 years of age: 3 – atropine/2-Pralidoxime IM via auto-injector

Advanced Medical Care

1. Treatment Adult
 - A. Mild effects: atropine 2 mg IV, IM, IO
 - B. Moderate effects: atropine 4 mg IV, IM, IO
 - C. Severe effects: atropine 6 mg IV, IM, IO
 - D. Seizures: midazolam 10 mg IM, IN
2. Treatment Pediatric
 - A. Mild – moderate symptoms
 - i. Atropine 0.02 – 0.05 mg/kg IV, IM, IO (maximum 4 mg)
 - ii. Repeat 0.02 mg/kg IV, IM, IO in 5 minutes as indicated (maximum 2 mg)
 - B. Severe symptoms
 - i. Atropine 0.02 – 0.05 mg/kg IV, IM, IO (maximum 6 mg)
 - A. Seizures: midazolam 0.15 mg/kg IM (max 10 mg); 0.2 mg/kg IN (max 10 mg)
3. Repeat atropine every 3-5 minutes as indicated

CHEMPACK Program

- * For multiple patients, call for CHEMPACK deployment per local emergency management and Metrolina Healthcare Coalition
- * 1 EMS CHEMPACK supports 454 patients
- * Medication in CHEMPACK may be used regardless of expiration date

EMS Type CHEMPACK Container 454 Person Treatment Capacity			
Product	Cases	Units per case	Total Units
Mark 1 Auto-injector	5	240	1,200
-OR-			
ATNA Auto-injector	6	200	1,200
-OR-			
Atropen 2mg Auto-injector	9	136	1,224
Pralidoxime 300mg Auto-injector	5	240	1,200
-AND-			
Diazepam 10mg Auto-injector	2	300	600
Seizalam (Midazolam) 5mg/ml vial 10ml	1	100	100
Atropen 0.5mg Auto-injector	1	225	225
Atropen 1mg Auto-injector	1	225	225
Atropine Sulfate 0.4mg/ml vial 20ml	1	100	100
Pralidoxime 1gm inj. 20ml	1	276	276
Sterile Water 20ml vials	1	150	150

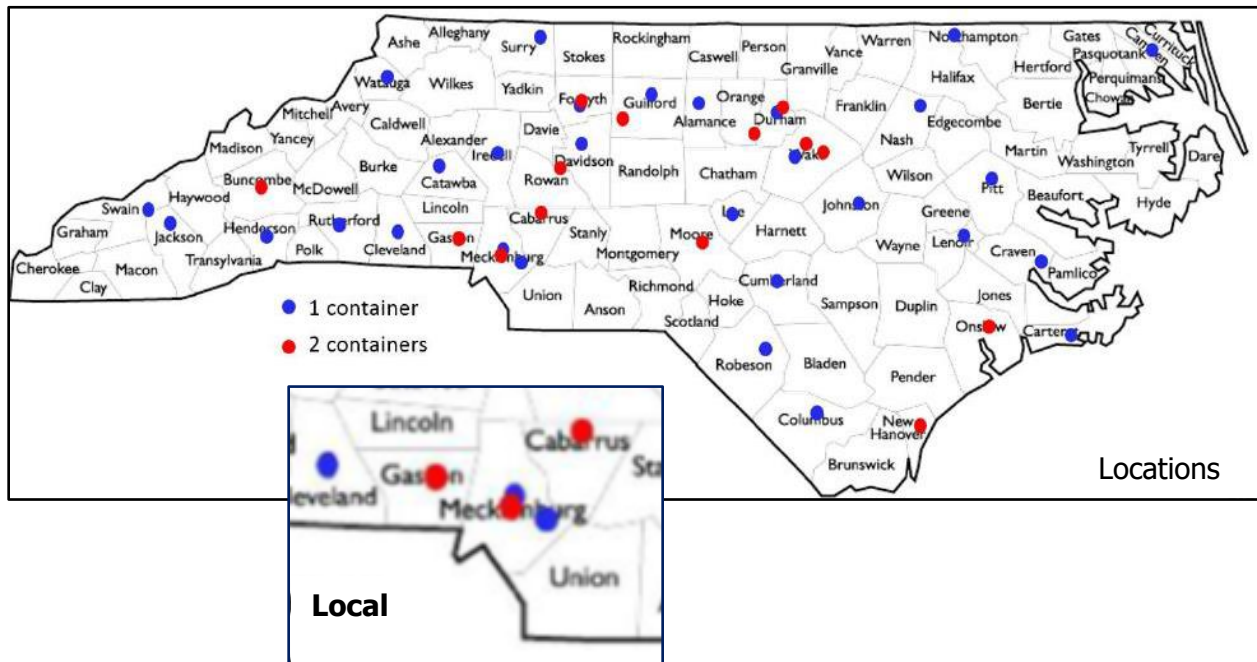

Radiation Incident (TB-7)

Basic Medical Care

1. Ensure scene safety
2. [START Triage Protocol](#)
3. [Medical Initial Assessment](#) or [Trauma Initial Assessment Protocol](#) as indicated
4. [Pediatric Initial Assessment](#) or [Pediatric Trauma Assessment Protocol](#) as indicated
5. Attempt to assess the type and duration of exposure
6. Decontaminate with copious amounts of normal saline irrigation
7. Additional care as per appropriate associated protocol

Additional Considerations

Time Phases of Radiation Injury (Exposure Dose vs Clinical Outcome)					
Exposure Dose (Gy)	Prodrome Severity	Manifest Illness - Symptom Severity			Prognosis
		Hematologic	Gastrointestinal	Neurologic	
0.5 to 1.0	+	+	0	0	Survival almost certain
1.0 to 2.0	+/**	+	0	0	Survival >90 percent
2.0 to 3.5	**	**	0	0	Probable survival
3.5 to 5.5	***	***	+	0	Death in 50% at 3.5 to 6 wks
5.5 to 7.5	***	***	**	0	Death probable in 2-3 wks
7.5 to 10	***	***	***	0*	Death probable in 1-2.5 wks
10 to 20	***	***	***	***	Death certain in 5-12 days
> 20	***	***	***	*****	Death certain in 2-5 days

Abbreviations: Gy: dose in Grey;
0: no effects; +: mild; **: moderate; ***: severe or marked

* Hypotension
** Also cardiovascular collapse, fever, shock

Modified from : Waselenko, JK, MacVittie, TJ, Blakely, WF, et al. Medical management of the acute radiation syndrome: Recommendations of the strategic national stockpile radiation working group. Ann Int Med 2004; 140:1039.

- * Classes of radiation
 - Ionizing
 - Greater energy, most dangerous
 - Alpha particles, beta particles, gamma rays
 - Non-ionizing
 - Lower energy
 - Microwaves, radios, lasers, visible light
- * Mechanisms of protection from radiation sources
 - Limit time of exposure
 - Increase distance from source
 - Shield from source

Cardiac Arrest (AC-3)

Differential Diagnosis

- * Asystole
- * Pulseless Electrical Activity
- * Ventricular fibrillation
- * Ventricular tachycardia without a pulse

Considerations

- | | |
|------------------------|-----------------------------------|
| * Medical vs. trauma | * Events preceding cardiac arrest |
| * Past medical history | * Estimated downtime |
| * Current medications | * Pre-arrival treatment |
| * DNR order | |

Basic Medical Care

1. [Medical Initial Assessment Protocol](#) or [Pediatric Initial Assessment Protocol](#)
2. Immediately following arrival on the scene, the attending paramedic (or EMTCC) will proceed directly to the patient
 - A. Once at the patient's side, check for pulses and breathing
 - i. If absent, will begin chest compressions
 - ii. Compressions: \geq 2-inch depth & permit full chest recoil
 - iii. Compression rate = 110/minute
 - B. If bystander chest compressions are being administered, proceed to perform airway interventions (be certain to ensure chest compressions are being performed appropriately)
3. EMT or non-attending paramedic will bring in equipment, proceed directly to the patient's airway and check for breathing & if absent:
 - A. Insert BIAD airway device and begin ventilations or
 - B. Utilize BVM with OPA/NPA as indicated and 100% oxygen for ventilations
 - C. Insert orogastric tube and connect to suction
 - D. Provide one ventilation every 20th compression
 - i. Pediatrics (\leq 14-years) provide one ventilation every 10th compression
 - E. Apply Zoll Monitor/Defibrillator
 - i. If only BLS providers on scene ensure AED mode & follow AED prompts
 - F. After 200 compressions, relieve paramedic with chest compressions
 - i. The paramedic will continue with Advanced Medical Care
4. With First Responder performing compressions and AED in place
 - A. Complete current 200 compressions cycle on the AED
 - B. Analyze and follow AED recommendation
 - C. Post AED recommendation, immediately resume CPR with CPR feedback device in place and swap pads deploying Zoll monitor/defibrillator

Advanced Medical Care

1. Upon Paramedic crew arrival
 - A. Paramedic will proceed to the patient's side and initiate intravenous (IV) line
 - i. If unable to quickly place IV access; initiate intraosseous (IO) line as indicated per [Parenteral Access: IO Protocol](#) and ACLS interventions
 - B. EMT-Basic or Non-Crew Chief Paramedic will deploy the ALS monitor including defibrillation pads, CPR feedback device, SpO₂ monitor and ETCO₂ adaptor
2. If BIAD placement unsuccessful or ineffective – perform endotracheal intubation (adults)
 - A. Compressions must NOT be interrupted for any attempt at intubation
 - B. Confirm placement via standard technique
3. EMT-Basic or Non-Crew Chief will prepare IVF for infusion then assume ready position to assume ventilations at the next position change following 200 compressions cycle and enter same rotation through positions with first responders
4. While rapid defibrillation is the treatment of choice for ventricular fibrillation, CPR should be performed on all adult unwitnessed cardiac arrests regardless of initial rhythm for 200 compressions prior to defibrillation attempt
5. For pediatric ventricular fibrillation arrest, early defibrillation is important
 - A. Ventricular fibrillation is seen in cardiomyopathies, myocarditis, hypoxia, or intoxication
 - B. Airway control and oxygenation are of paramount importance
 - C. Pediatric patients in cardiac arrest from a medical etiology should NOT be expeditiously carried to the ambulance when it arrives
 - i. For maximum survival benefit, resuscitative efforts should be conducted on the scene with two or more rescuers performing CPR
 - D. Resuscitation and transport should be performed on all pediatric cardiac arrest patients regardless of etiology – medical or trauma
 - E. Indicated ALS medications should be administered for both pediatric medical and trauma arrest
6. After each defibrillator shock, chest compressions should commence immediately
7. Additional care as per specific dysrhythmia protocol

Additional Considerations

- * For suspicion of opioid associated cardiac arrest: administer naloxone (Narcan®) 2 mg IV
 - Attention must be on airway, oxygenation, ventilation, and cardiac arrest care
 - Naloxone (Narcan®) has not been associated with improved outcome once cardiac arrest has occurred and therefore is not indicated in all cardiac arrest events
- * Ensure hyper/over ventilation does NOT occur
 - Feedback in the form of end-tidal CO₂ and verbal queues are important to the provider administering the ventilations to avoid hyperventilation
- * With ETCO₂ spike consider return of spontaneous circulation
- * Maximum total epinephrine (1:10,000) dosage during cardiac arrest care = 5 mg
- * Maternal cardiac arrest: follow appropriate protocol
 - Manually displace uterus to the patient's left

Ventricular Fibrillation, Pulseless VT (AC-9/PC-6)

Witnessed by EMS provider:

1. Immediately initiate CPR as defibrillation pads are applied and defibrillator charged
 - A. Adults: defibrillate @ 150 Joules as soon as pads are applied & charged
 - B. Pediatrics: defibrillate @ 2 Joules/kg as soon as pads are applied & charged
2. If defibrillation pads are already in place → immediately defibrillate
3. Immediately resume CPR post-shock delivery
4. Perform ventilations
 - A. Adults: one ventilation every 20th compression
 - B. Pediatrics: one ventilation every 10th compression

Unwitnessed by EMS provider

1. Perform CPR for 200 compressions
 - A. Rate: 110 compressions per minute
2. Pre-charge defibrillator at compression #180
 - A. Adults: 150 Joules
 - B. Pediatrics: 2 Joules/kg (maximum 150 Joules)
 - C. May utilize first responder AED if applied and nearing end of 200 compression cycle
3. Perform defibrillation
4. Immediately resume CPR post-shock delivery
5. Perform ventilations at rate of 6 ventilations/minute for adults
 - A. One ventilation should occur each 20th compression
6. Perform ventilations at rate of 12 ventilations/minute for pediatric patients (\leq 14-years)
 - A. One ventilation should occur each 10th compression

Additional Considerations

- * Ensure hyperventilation / over-ventilation does not occur

VF, Pulseless VT Present/Persisting after Initial Intervention

1. Continue CPR for 200 compressions
2. Pre-charge defibrillator at compression #180
3. Check rhythm
 - A. Organized → check pulses
 - i. No pulse present → continue CPR for cycle of 200 compressions
 - ii. Pulse present → referred to [Post-Resuscitation Protocol](#)
 - B. Persistent VF/VT without pulse → Perform defibrillation
 - i. Adults: 200 Joules
 - ii. Pediatrics: 4 Joules/kg (maximum 150 Joules)
4. Immediately resume CPR post-shock delivery
5. Continue with cycles of 200 compressions between rhythm/pulse checks
6. Epinephrine (1:10,000) every 5 minutes
 - A. Adults: 1 mg IV, IO
 - B. Pediatrics: 0.01 mg/kg; (0.1 ml/kg) IV, IO (maximum: 1 mg; 1 ml)
7. For persistent VF/VT
 - A. Lidocaine 1.5 mg/kg IV, IO
 - B. Repeat x1 additional dose at 0.5 mg/kg in 5 – 10 minutes as indicated
 - C. Magnesium sulfate
 - i. Adults: 2 grams IV, IO over 2 minutes
 - ii. Pediatrics: 50 mg/kg IV, IO over 2 minutes (maximum 2 grams)
8. Total arrest time > 15 minutes
 - A. Sodium bicarbonate
 - i. Adults: 50 mEq (50 ml) IV, IO
 - ii. Pediatrics: 1 mEq/kg (1 ml/kg); max 50 mEq (50 ml) IV, IO
 - iii. Repeat every 10 minutes
9. If rhythm converts to organized rhythm with palpable pulses and lidocaine has not previously been administered: lidocaine at dose outlined above
10. Total ACLS resuscitation time > 20 minutes, no ROSC, and ETCO₂ < 20 mmHg
 - A. Patients with refractory/recurrent ventricular fibrillation/tachycardia should be transported to the closest emergency department with continued resuscitative efforts
11. Any time rhythm changes to alternate rhythm refer to the appropriate protocol

Additional Considerations

- * Following three (3) unsuccessful defibrillation attempts, (any combination of AED and/or manual defibrillation) change location of defibrillation pads (from right upper-apex to anterior-posterior)

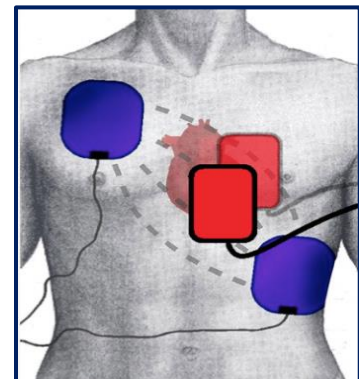

Torsades de Points (AC-8)

1. Pulseless and witnessed by EMS provider:
 - A. Initiate CPR as defibrillation pads are applied and defibrillator charged
 - i. Adults: defibrillate @ 150 Joules as soon as pads are applied & charged
 - ii. Pediatrics: defibrillate @ 2 Joules/kg as soon as pads are on & charged
 - B. If defibrillation pads are already in place → immediately defibrillate
 - C. Immediately resume CPR post-shock delivery
 - D. Perform ventilations at rate of 6 ventilations per minute
2. Pulseless and unwitnessed by EMS provider
 - A. Perform CPR for 200 compressions
 - B. Perform defibrillation
 - i. Adults: 150 Joules
 - ii. Pediatrics: 2 Joules/kg (maximum 150 Joules)
 - C. Immediately resume CPR post-shock delivery
 - D. Perform ventilations at rate of 6 ventilations per minute (adult)
 - i. Rate of 12 ventilations per minute (pediatrics ≤ 14-years)
3. Magnesium sulfate
 - A. Adults: 2 grams IV, IO
 - B. Pediatrics: 50 mg/kg IV, IO (maximum 2 grams)
 - C. Repeat in 5 – 10 minutes if Torsades persists
4. Epinephrine (1:10,000) every 5 minutes
 - A. Adults: 1 mg IV, IO
 - B. Pediatrics: 0.01 mg/kg; (0.1 ml/kg) IV, IO (maximum 1 mg; 1 ml)
5. Continue CPR for 200 compressions
6. Pre-charge defibrillator at compression #180
7. Check rhythm
 - A. Organized → check pulses
 - i. No pulse present → continue CPR for cycle of 200 compressions
 - ii. Pulse present → referred to [Post-Resuscitation Protocol](#)
 - B. Persistent VF/VT without pulse → Perform defibrillation
 - i. Adults: 200 Joules
 - ii. Pediatrics: 4 Joules/kg (maximum 150 Joules)
8. Immediately resume CPR post-shock delivery
9. Continue with cycles of 200 compressions between rhythm/pulse checks
10. Total arrest time > 15 minutes
 - A. Sodium bicarbonate (repeat every 10 minutes)
 - i. Adults: 50 mEq (50 ml) IV, IO
 - ii. Pediatrics: 1 mEq/kg (1 ml/kg); max 50 mEq (50 ml) IV, IO
11. If rhythm converts to organized rhythm with palpable pulses and lidocaine has not previously been administered: lidocaine at dose outlined above
12. Total ACLS resuscitation time > 20 minutes, no ROSC, and ETCO₂ < 20 mmHg
 - A. Patients with refractory/recurrent Torsades should be transported to the emergency department with continued resuscitative efforts
13. ALL pediatric patients should be transported to the closest emergency department

Pulseless Electrical Activity (AC-1/PC-1)

1. Perform CPR for 200 compressions
2. Epinephrine (1:10,000)
 - A. Adults: 1 mg IV, IO
 - B. Pediatrics: 0.01 mg/kg; (0.1 ml/kg) IV, IO
 - i. Administration early as possible in resuscitation of non-shockable rhythms
3. Check rhythm
 - A. Organized → check pulses
 - B. No pulse present → continue CPR for next cycle of 200 compressions
 - C. Pulse present → referred to [Post-Resuscitation Protocol](#)
4. Continue with cycles of 200 compressions between rhythm/pulse checks
 - A. Pre-charge defibrillator at compression #180
5. Epinephrine (1:10,000) every 5 minutes
 - A. Adults: 1 mg IV, IO
 - B. Pediatrics: 0.01 mg/kg; (0.1 ml/kg) IV, IO (maximum 1 mg; 1 ml)
6. Consider administration of dopamine @ 10 – 20 mcg/kg/min
 - A. **ONLY** if concern for pseudo-PEA (extreme hypotension)
7. Total arrest time > 15 minutes
 - A. Sodium bicarbonate
 - i. Adults: 50 mEq (50 ml) IV, IO
 - ii. Pediatrics: 1 mEq/kg (1 ml/kg) maximum 50 mEq (50 ml) IO, IV
 - iii. Repeat every 10 minutes
8. Consider causes of PEA and their associated treatment:
 - A. Hypoxia: oxygenation
 - B. Hypovolemia: IVF bolus
 - C. Hyperkalemia: Calcium gluconate
 - i. Adult: 2 grams of 10% solution IV (20 ml)
 - ii. Pediatric: 20 mg/kg IO, IV (0.2 ml/kg); maximum 2 grams (20 ml)
 - D. Hypothermia: active rewarming
 - E. Acidosis: sodium bicarbonate 1 mEq/kg (maximum 50 mEq) IV, IO
 - F. Overdose: drug specific therapies
 - i. Tricyclic Antidepressant (TCA): sodium bicarbonate
 - ii. Opioid: Naloxone (Narcan®) 2 mg IV, IO
 - Consider post-resuscitation in other cases if patient hypoventilating
 - G. Acute Myocardial infarction: [Chest Pain: Cardiac & STEMI Protocol](#)
 - H. Cardiac tamponade: IVF bolus
 - I. Tension pneumothorax: chest needle decompression
 - J. Pulmonary embolus: maximize oxygenation
9. Total ACLS resuscitation time > 20 minutes, no ROSC, and ETCO₂ < 20 mmHg
 - A. May pronounce dead on scene (adults only)
 - B. Notify police if not already on scene
10. Total ACLS resuscitation time > 20 minutes: ALL pediatric patients and adults not pronounced on scene should be transported to the closest emergency department
11. Any time rhythm changes to alternate rhythm refer to the appropriate protocol

Asystole (AC-1/PC-2)

1. Initiate CPR for 200 compressions
2. Epinephrine (1:10,000)
 - A. Adults: 1 mg IV, IO
 - B. Pediatrics: 0.01 mg/kg; (0.1 ml/kg) IV, IO
 - i. Administration early as possible in resuscitation of non-shockable rhythms
3. Check rhythm
 - A. Organized → check pulses
 - B. No pulse present → continue CPR for next cycle of 200 compressions
 - C. Pulse present → referred to Post-Resuscitation Protocol
4. Continue with cycles of 200 compressions between rhythm/pulse checks
 - A. Compressions must NOT be interrupted for airway management
 - B. Limit time off the chest to < 10 seconds during rhythm checks
5. Epinephrine (1:10,000) every 5 minutes
 - A. Adults: 1 mg IV, IO
 - B. Pediatrics: 0.01 mg/kg; (0.1 ml/kg) IV, IO (maximum 1 mg; 1 ml)
6. Total arrest time > 15 minutes
 - A. Sodium bicarbonate
 - i. Adults: 50 mEq (50 ml) IV, IO
 - ii. Pediatrics: 1 mEq/kg (1 ml/kg); maximum 50 mEq (50 ml) IV, IO
 - iii. Repeat every 10 minutes
7. Dextrose (D10) IV for hypoglycemia
 - A. Adults: 100 ml IV, IO
 - B. Pediatrics:
 - i. ≥ 8 years: 5 ml/kg IV, IO (maximum 100 ml)
 - ii. 31 days – 8 years: 2 ml/kg IV, IO (maximum 100 ml)
 - iii. 0 – 30 days of age: 2 ml/kg IV, IO
8. Total ACLS resuscitation time > 20 minutes, no ROSC, and ETCO₂ < 20 mmHg
 - A. May pronounce dead on scene (adults only)
 - B. Notify police if not already on scene
9. Naloxone (Narcan®) 2 mg IV for suspicion of opioid associated cardiac arrest
 - Attention must be on airway, oxygenation, ventilation, and cardiac arrest care
 - Naloxone (Narcan®) has not been associated with improved outcome once cardiac arrest has occurred and therefore is not indicated in all cardiac arrest events
10. Total ACLS resuscitation time > 20 minutes: ALL pediatric patients and adult patients not pronounced on scene should be transported to the closest emergency department
11. Any time rhythm changes to alternate rhythm refer to the appropriate protocol

Pulseless Wide-complex bradycardia, prolonged QT-interval, or sine wave possibly resulting from hyperkalemia

1. Initiate CPR
2. Calcium gluconate (10%)
 - A. Adult: 2 grams (20 ml) IV, IO over 2 minutes
 - B. Pediatric: 20 mg/kg IV, IO (0.2 ml/kg) maximum 2 grams (20ml) over 2 minutes
 - C. Repeat in 10 minutes as indicated by patient condition and rhythm
3. Sodium bicarbonate
 - A. Adult: 50 mEq (50 ml) IV, IO
 - B. Pediatric: 1 mEq/kg (1 ml/kg) maximum 50 mEq (50 ml) IV, IO
4. Epinephrine (1:10,000) every 5 minutes
 - A. Adults: 1 mg IV, IO
 - B. Pediatrics: 0.01 mg/kg; (0.1 ml/kg) IV, IO (maximum 1 mg; 1 ml)
5. Total ACLS resuscitation time > 20 minutes, no ROSC, and ETCO₂ < 20 mmHg
 - A. May pronounce dead on scene (adults only)
 - B. Notify police if not already on scene
6. Total ACLS resuscitation time > 20 minutes: ALL pediatric patients and adults not pronounced on scene should be transported to the closest emergency department
7. Any time rhythm changes to alternate rhythm refer to the appropriate protocol

Additional Considerations

- * Patients at risk for hyperkalemia
 - Renal failure (especially if patient has missed scheduled dialysis)
 - DKA
 - Crush syndrome/rhabdomyolysis
 - Severe burns
- * Rate of rhythm associated with hyperkalemia may be slow, normal, or fast

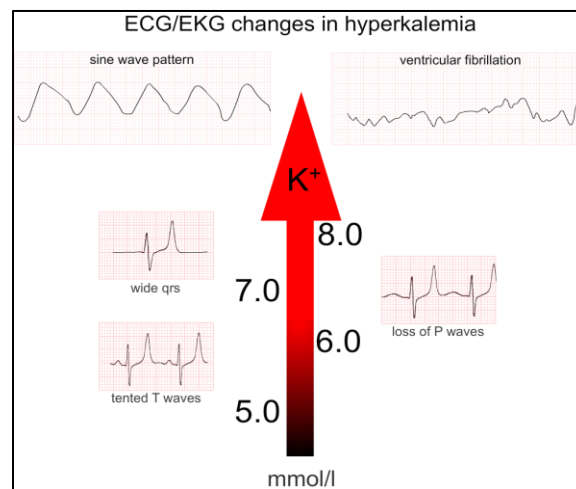

Adult Blunt Trauma Arrest (TB-10)

1. For patient found to be pulseless, apneic, and without signs of life, may pronounce dead on scene
2. If patient noted at any time to have palpable pulse attempt resuscitation & transport
3. If patient becomes pulseless and apneic on scene:
 - A. For blunt trauma to the torso with suspicion for tension pneumothorax perform chest needle thoracostomy bilaterally
 - B. For asystole or wide complex PEA, no signs of life, and transport to trauma center is > 5 minutes, may pronounce dead on the scene
 - C. For narrow complex PEA or shockable rhythm, initiate/continue resuscitative efforts and transport to the trauma center
4. If the patient becomes pulseless and apneic during transport:
 - A. Perform bilateral needle decompression – for blunt chest trauma
 - B. For asystole or wide complex PEA, no signs of life, and transport to trauma center is > 5 minutes, may pronounce dead
 - C. For narrow complex PEA or shockable rhythm, initiate/continue resuscitative efforts and transport to the trauma center
 - D. Notify receiving facility and continue transport
5. Advanced Airway management as indicated
 - A. [Airway: BIAD Protocol](#)
 - B. [Airway: Intubation Protocol](#)
6. Ensure proper tube placement using capnometry, SpO₂ and ventilate with 100% oxygen

Adult Penetrating Trauma Arrest

1. For patient found to be pulseless, apneic, and without signs of life, may pronounce dead on the scene
2. If patient noted at any time to have palpable pulses, continue resuscitation and transport
3. If patient becomes pulseless and apneic and transport time to trauma center is < 15 minutes, continue resuscitation and transport
4. For penetrating trauma to the upper torso with suspicion for tension pneumothorax perform chest needle thoracostomy
 - A. Notify receiving facility and continue transport
 - B. If patient becomes pulseless and apneic and transport time to trauma center is > 15 minutes, contact medical control
5. Advanced airway management as indicated
 - A. [Airway: BIAD Protocol](#)
 - B. [Airway: Intubation Protocol](#)
6. Ensure proper tube placement using capnometry, SpO₂ and ventilate with 100% oxygen

Pediatric Blunt or Penetrating Trauma Arrest

1. Initiate resuscitation and transport
2. Evaluate rhythm and treat per appropriate protocol
3. Advanced Airway management as indicated
 - A. **Airway: BIAD Protocol**
4. Ensure proper tube placement using capnometry, SpO₂ and ventilate with 100% oxygen
5. For blunt or penetrating trauma to the torso with suspicion for tension pneumothorax perform chest needle thoracostomy
6. Epinephrine (1:10,000) 0.01 mg/kg IV, IO (max. 1 mg) every 5 minutes
7. Total arrest time > 15 minutes
 - A. Sodium bicarbonate 1 mEq/kg (1 ml/kg) maximum 50 mEq (50 ml) IO, IV

Additional considerations

- * Epinephrine and/or atropine are NOT indicated in the resuscitation of **ADULT** cardiac arrest as the result of blunt or penetrating trauma
 - Exception: For the traumatic event believed to be the result of a cardiac event – treat dysrhythmia as per medical cardiac arrest guidelines
- * Unlike adult traumatic cardiac arrest, ACLS medications may be indicated in pediatric traumatic cardiac arrest
- * For traumatic cardiac arrest transport should be expedited with resuscitation efforts performed enroute vs. remaining on scene
 - Traumatic arrest requires expedited transport for definitive care
 - This may include operative intervention, massive blood transfusion protocols, or emergency department thoracotomy
 - Traumatic arrest etiology is distinctly different from that of medical arrests for whom performing resuscitative efforts on scene is more beneficial for patients

Post-Resuscitation Care (AC-9/PC-7/AC-10)

Traumatic Cardiac Arrest

1. Post resuscitation from traumatic cardiac arrest continue with destination as per [Trauma Triage Destination](#) and with trauma care as per appropriate protocol

Medical Cardiac Arrest – PRIOR to Patient Movement from Point of Resuscitation

1. Assess mental status
2. Obtain 12-lead ECG
3. Assess cardiac rhythm and vital signs (ensure manual BP measurement)
4. Provide supplemental oxygen to maintain SpO₂ = 94 – 97%
5. Ensure adequate IV access (2 sites)
6. Assess blood glucose level: D10 as indicated
7. Hypotension
 - A. Ensure adequate volume resuscitation
 - B. Adult: IVF at wide open rate (2 liters chilled normal saline initial choice)
 - C. Pediatric: 20 ml/kg IVF bolus
 - D. Dopamine @ 10 – 20 mcg/kg/min IV, IO
8. Adult Bradycardia (symptomatic)
 - A. Atropine 0.5 mg IV, IO
9. Pediatric Bradycardia
 - A. Epinephrine (1:10,000) 0.01 mg/kg IV, IO (maximum 1 mg)
 - B. For continued bradycardia: atropine 0.02 mg/kg IV, IO (min 0.1 mg, max 1 mg)
 - C. HR < 60: initiate chest compressions
10. Adult 2nd degree type II or 3rd degree heart block
 - A. [Transcutaneous Pacing Protocol](#)
11. Continue to treat dysrhythmias as per appropriate protocol
12. Do NOT hyperventilate
 - A. Ensure ventilation rate maintained @ 6 – 10 per minute
 - B. For pediatrics (≤ 14-years) ensure rate maintained @ 12 – 20 per minute
 - C. Goal is normalization of ETCO₂ 35 – 45 mmHg
13. Plan/arrange for most appropriate method for transition from scene to ambulance
14. Do not attempt scene transition until full patient assessment and resuscitation has been completed (ECG, BP, IVF, vasopressor, anti-dysrhythmic, transcutaneous pacing)
15. Ensure consistent palpation of pulse during patient transition from scene to ambulance
 - A. Reassess at multiple points during egress from scene
16. Ensure consistent evaluation of rhythm during patient transition from scene to ambulance
 - A. Reassess at multiple points during egress from scene
17. Continue to treat any presumptive diagnosis being treated prior to cardiac arrest
18. Reassess frequently during transport
19. Plan/arrange for most appropriate method for transition from ambulance to hospital
20. Ensure consistent evaluation of pulse and rhythm during transition from ambulance

Additional Considerations

- * For cardiac arrest from a medical etiology, it is better to attempt resuscitation and stabilization on the scene rather than in a moving ambulance
- * For cardiac arrest from a trauma etiology, it is better to attempt resuscitation as indicated during transport to the trauma center
- * While rapid defibrillation is the treatment of choice for ventricular fibrillation, CPR should be performed on all adult unwitnessed cardiac arrests prior to administering shock
- * Chest compressions should be hard and fast, bringing the hand the upstroke off the chest for maximum recoil
 - Chest compressions should be started immediately after each shock
- * Chest compressions should NEVER be interrupted except when performing rhythm analysis or delivering defibrillation shock
 - When compressions are interrupted for rhythm analysis or defibrillation shock this time should be limited to < 6 seconds
 - Provider performing compressions must count aloud every 20th compression
 - Defibrillator should be pre-charged at compression #180
 - Providers must change positions every 200 compressions
- * Feedback in the form of end-tidal CO₂ and verbal queues are important to the provider administering the ventilations to avoid hyperventilation
- * In any patient in cardiac arrest, consider hypoglycemia
 - Assess glucose level or consider administration of D10 IV
- * Use of magnesium sulfate is contraindicated in patients with renal insufficiency or on dialysis except in cases of Torsades de Points
- * If peripheral access is unobtainable and the patient has access via a central intravenous line or dialysis catheter, this may be used for fluid and medication administration
- * If the patient < 70-years of age, the cardiac arrest was witnessed, and the suspected etiology of cardiac arrest is a pulmonary embolism (based on risk factors, sudden onset of symptoms, young age, absent premorbid conditions), MEDIC should consider continued resuscitation, transport, and not pronounce dead
 - The patient should be prepared for transport as expeditiously as possible for possible thrombolytic administration immediately following hospital arrival
- * For suspicion of opioid associated cardiac arrest: administer naloxone (Narcan®)
 - Attention must be on airway, oxygenation, ventilation, and cardiac arrest care

Focused Cardiac Arrest (AC-11)

First Responder Arrives Prior to Medic

1. [Medical Initial Assessment Protocol](#) or [Pediatric Initial Assessment Protocol](#)
2. Firefighter-1 or designee will check for pulses
 - A. If absent, will begin chest compressions.
3. Firefighter-2 or designee will check for responsiveness and breathing
 - A. If absent will perform the following:
 - i. Adult: Insert the blind insertion airway device and begin ventilations
 - Insert orogastric tube and connect to suction
 - ii. Pediatric: Provide assisted ventilations with BVM and 100% oxygen
4. The Captain or designee will attach the automatic external defibrillator, deploy the QCPR meter, and activate immediately for first responder witnessed arrests or after 200 chest compressions have been performed for arrests not witnessed by First Responder
5. Ensure CPR is being performed for 200 compressions while applying defibrillator (AED)
6. Follow AED prompts for potential defibrillation in coordination with compression cycles
7. Provider performing compressions will count aloud the first compression "1" and subsequently count aloud every 20th compression (i.e. "20", "40", "60", ...)
8. Provider performing ventilations will provide one ventilation with every 20th chest compression (provide one ventilation every 10 compressions for pediatrics \leq 14-years)
9. Captain: check for femoral pulse during compressions "180" through "200" and perform defibrillation as indicated by the AED rhythm analyzation after compression "200"
 - A. Ensure timely defibrillation after analyzation and immediately resume compressions post-shock
10. The engineer will take a ready position to assume compressions following the initial set of 200 chest compressions
11. After each defibrillator shock, chest compressions should commence immediately
12. Following 200 compressions each provider will move to the next role
 - A. As provider performing compressions announces "180", providers will prepare to move to the next role
 - B. Immediately after compression 200, provider performing compressions will move to the head of the patient to assume ventilations
 - C. Immediately after compression 200, provider performing ventilations will move the patient's side ("on deck") and prepare for assuming compressions at the next position change
 - D. Captain will perform defibrillation as indicated by the AED
 - E. The provider who was "on deck" and is now prepared to provide compressions will perform compressions after AED analyzation and shock (if shock indicated)
 - F. Provider now performing compressions will count aloud the first compression "1" and subsequently count aloud every 20th compression
13. Perform ventilations at a rate of 6 ventilations per minute (every 20th compression)
 - A. Provide one ventilation every 10 compressions for pediatrics < 14-years
14. Analyze rhythm after every 200 compressions cycle of CPR
15. Repeat defibrillation as indicated
16. Each provider will change rotated position after every 200-compression cycle of CPR

Advanced Medical Care

1. Upon Paramedic crew arrival
 - A. Attending paramedic will proceed to the patient's side and initiate intravenous (IV) or **Parenteral Access: Venous-Extremity** intraosseous (IO) line per **Parenteral Access: Venous-Extremity** and ACLS interventions as indicated
 - B. After current round of compressions completed and AED has delivered shock or noted non-shockable rhythm, EMT-Basic or Non-Crew Chief Paramedic will deploy the cardiac monitor including Medic defibrillation pads, CPR feedback device, SpO₂ monitor and ETCO₂ adaptor
2. EMT-Basic or Non-Crew Chief will prepare IVF for infusion then assume ready position to assume ventilations at the next position change following 200 compressions cycle of CPR and enter same rotation through positions with first responders
3. While rapid defibrillation is the treatment of choice for ventricular fibrillation, CPR should be performed on all adult unwitnessed cardiac arrests regardless of initial rhythm for at least 200 compressions prior to defibrillation attempt
4. For pediatric ventricular fibrillation arrest, early defibrillation is more important
 - A. Ventricular fibrillation is seen in cardiomyopathies, myocarditis, hypoxia, or intoxication
 - B. Airway control and oxygenation are of paramount importance
 - C. Pediatric patients in cardiac arrest from a medical etiology should not be expeditiously carried to the ambulance when it arrives
 - i. For maximum survival benefit, resuscitative efforts should be conducted on the scene with two or more rescuers performing CPR
 - D. Resuscitation and transport should be performed on all pediatric cardiac arrest patients regardless of etiology – medical or trauma
 - E. Indicated ALS medications should be administered for both pediatric medical and trauma arrest
5. Ensure every 20th compression is being counted aloud ("20", "40", "60", ...)
6. "Pre-charge defibrillator" with compression #180
7. Palpate femoral pulse compressions #180 – 200
8. Analyze rhythm immediately following compression #200:
 - A. For ventricular fibrillation or ventricular tachycardia without a pulse immediately defibrillate @ 150 J
 - B. For asystole or PEA immediately resume compressions and disarm defibrillator
 - i. Ensure providers have rotated positions
 - A. For perfusing rhythm, immediately initiate post-resuscitation care
9. Repeat 5 through 8 as indicated by rhythm every 200 compressions
10. Perform ventilations at a rate of 6 ventilations/minute (adults) 12/minute pediatrics \leq 14-years
11. The Captain or designee will initiate documentation and continue throughout the resuscitation period on the scene

Medic Arrives Prior to First Responder

1. **Medical Initial Assessment Protocol or Pediatric Initial Assessment Protocol**
2. Immediately following arrival on the scene, the attending Paramedic or EMTCC will proceed directly to the patient
 - A. Once at the patient's side, check for pulses and breathing
 - i. If absent, will begin chest compressions
3. The non-attending EMT or Paramedic will bring in equipment, proceed directly to the patient's airway and check for breathing
 - A. If absent, perform the following:
 - i. Adult
 - Insert BIAD airway device and begin ventilations
 - Utilize BVM and 100% oxygen for ventilations
 - Insert orogastric tube and connect to suction
 - ii. Pediatric
 - Provide ventilations with BIAD or bag-valve-mask & 100% oxygen
 - B. Do NOT interrupt compression for airway management
4. For BLS crew: apply AED
 - A. Follow AED prompts for potential defibrillation in coordination with compression cycles
5. For ALS crew: deploy the cardiac monitor including defibrillation pads, CPR meter, SpO₂ monitor and ETCO₂ adaptor
6. Ensure every 20th compression is being counted aloud ("20", "40", "60", ...)
7. "Pre-charge defibrillator" with compression #180
8. Palpate femoral pulse compressions #180 – 200
9. Analyze rhythm immediately following compression #200:
 - A. For ventricular fibrillation or ventricular tachycardia without a pulse immediately defibrillate @ 150 J
 - B. For asystole or PEA immediately resume compressions and disarm defibrillator
 - i. Ensure providers have rotated positions
 - C. For perfusing rhythm, immediately initiate post-resuscitation care
10. Repeat 5 through 8 as indicated by rhythm every 200 compressions
11. Perform ventilations at a rate of 6 ventilations/minute – adults
 - A. Perform ventilations at 12 ventilations/minute – pediatrics ≤ 14-years
12. Upon arrival of first responder have personnel proceed immediately to their pre-designated positions as in **First Responder Arrives Prior to Medic** (see above)

Additional Considerations

- * For cardiac arrest witnessed by EMS provider immediately initiate chest compressions while AED/cardiac monitor and pads are deployed
 - For initial rhythm that is shockable (ventricular fibrillation, pulseless ventricular tachycardia), defibrillate immediately then resume chest compressions for 200 compression cycle
 - For rhythm that is NON-shockable perform 200 compression cycle and continue as outlined above
- * Chest compressions goals:
 - Limit time to defibrillation to < 6 seconds
 - There is an 18% increase in survival to hospital discharge for every 5 second decrease in time to defibrillation following chest compressions
 - Compressions should be performed $\geq 90\%$ of the time during the resuscitation efforts
 - Limit time "off the chest" to < 6 seconds for position rotations
 - Utilize CPR feedback to ensure adequate rate, depth, and release of chest
- * Ventilation goals:
 - Hyper/over ventilation must be avoided
 - Must avoid any increase in intrathoracic pressure which will in turn decrease coronary perfusion
 - Maintain ETCO₂ 35 – 45 mmHg
 - For First Responder or BLS only crews on scene, ventilate at rate of 6 breaths per minute (every 20th compression) – adults
 - Provide one ventilation every 10th compression for pediatrics ≤ 14 -years
- * Epinephrine during cardiac arrest care:
 - Maximum total amount for adult cardiac arrest = 5 mg
- * Documentation
 - Witnessed or unwitnessed
 - Record initial rhythm
 - Record any change in rhythm during the resuscitation
 - Medication(s) administered
 - Defibrillation(s) performed
 - Record the final rhythm
- * Opioid associated cardiac arrest:
 - Naloxone (Narcan[®]) is only indicated for patients with suspicion of narcotic overdose as the cause of their cardiac arrest
 - Attention must be on airway, oxygenation, ventilation, and cardiac arrest care

Chest Pain (non-cardiac etiology)

Differential Diagnosis

- * Angina
- * Aortic dissection
- * Asthma
- * Bronchitis
- * Bronchospasm
- * Cocaine abuse
- * COPD
- * Dysrhythmia
- * Esophageal spasm
- * Esophagitis
- * Marijuana abuse
- * Musculoskeletal pain
- * Myocardial infarction
- * Pericarditis
- * Pneumonia
- * Pneumothorax
- * Pulmonary embolus
- * Rib contusion/fracture
- * Sickle cell anemia crisis

Basic Medical Care

1. [Medical Initial Assessment Protocol](#) or [Pediatric Initial Assessment Protocol](#)
2. [Trauma Initial Assessment Protocol](#) or [Pediatric Trauma Assessment Protocol](#)
3. Maintain airway; suction as needed
4. Assess vital signs
5. Provide supplemental oxygen per patient condition to maintain SpO₂ = 94 – 97%
6. Provide assisted ventilations with bag-valve mask and 100% oxygen if breathing or ventilatory compromise is apparent
7. Allow all conscious patients to sit in a position of comfort
8. For chest pain considered to be of cardiac etiology refer to [Heart Problems Protocol](#)
9. Acetaminophen (Tylenol®) for pain control
 - A. Adult: 650 – 975 mg PO
 - B. Pediatric: 15 mg/kg PO (maximum 650 mg)

Advanced Medical Care

1. Obtain 4-lead ECG and refer to appropriate protocol as indicated
2. Obtain 12-lead ECG as per patient history
3. IVF bolus for signs of hypotension/dehydration
 - A. Adult: 500 – 1000 ml as per patient condition
 - B. Pediatric: 10 – 20 ml/kg
4. Dopamine @ 10 – 20 mcg/kg/min for persistent hypotension
5. Ondansetron (Zofran®) for nausea/vomiting
 - A. Adult: 4 – 8 mg IV, PO
 - B. Pediatric dose = 0.15 mg/kg IV, PO (maximum 4 mg)
6. Fentanyl for pain control
 - A. Indicated for significant non-cardiac chest pain or pain of presumed cardiac etiology pain persistent following 2 doses nitroglycerin administration
 - B. Adult
 - i. 1 – 2 mcg/kg IN (maximum 200 mcg)
 - ii. 0.5 – 1 mcg/kg IV, IM (maximum 100 mcg)
 - iii. May repeat x1 in 15 minutes as indicated (maximum 100 mcg any route)
 - C. Pediatric
 - i. 0.5 – 1 mcg/kg IV, IM, IN (maximum 100 mcg)
7. For chest pain considered to be of cardiac etiology refer to [Heart Problems Protocol](#)

Additional Considerations

- * Patients with suspected cardiac chest pain should have the 12-lead ECG performed immediately while on the scene
- * Patients above the age of 30-years with chest pain or any patient with a recent history of cocaine or crack use with chest pain should be considered at risk for cardiac disease
 - These patients should have a 12-lead ECG performed
 - ECG interpretation should be noted during radio report to medical control
 - Paramedic interpretation that is different than the computer interpretation should also be verbalized
- * An on-scene 12-lead ECG that appears normal or interpreted as unremarkable should never be used to convince a patient that their condition is stable
 - ~ 50% of acute myocardial infarctions will present with an unremarkable ECG
- * Pain from an aortic dissection may be described as ripping or tearing in nature
 - In this context, the examination should include bilateral blood pressures along with upper and lower extremity pulse assessments
- * Patients at risk for pulmonary embolism (patients on oral contraceptives, prolonged immobilization, recent surgery, prior history of clotting disorders) may show signs of tachycardia and tachypnea
 - The ECG may reflect the S1, Q3, T3 pattern
 - Although pattern is classical it may not be present in patients with a PE
 - Patients may also have an ECG reflecting incomplete RBBB or right heart strain

Choking

Differential Diagnosis

- * Anaphylaxis
- * Angioedema
- * Asthma
- * Cerebrovascular accident
- * Croup
- * Epiglottitis
- * Foreign body aspiration
- * Upper respiratory infection

Basic Medical Care

1. [Medical Initial Assessment Protocol](#) or [Pediatric Initial Assessment Protocol](#)
2. Maintain airway; suction as needed
3. Assess vital signs
4. Provide supplemental oxygen per patient condition to maintain SpO₂ = 94 – 97%
5. Provide assisted ventilations with bag-valve mask and 100% oxygen if breathing or ventilatory compromise is apparent
6. Partial or complete airway obstruction due to foreign body
 - A. Patient conscious
 - i. Encourage coughing
 - ii. Coughing ineffective → deliver 5 sub diaphragmatic abdominal thrusts
 - iii. Sub diaphragmatic thrusts ineffective (or pregnant patient) → deliver chest thrusts
 - iv. Continue thrusts until obstruction is relieved or unconsciousness occurs
 - B. Infant < 1 year of age conscious
 - i. If child coughing or making sounds, observe for further obstruction
 - ii. If choking progresses and cough is ineffective → deliver 5 back blows then 5 less forceful chest thrusts
 - iii. Continue cycle of back blows and chest thrusts until obstruction relieved
 - C. Patient unconscious
 - i. Open airway using head tilt-chin lift and check oral cavity for foreign body
 - ii. Use finger sweep as indicated if material is visualized
 - Do not perform blind finger sweeps
 - iii. Attempt ventilations
 - iv. Reposition airway as indicated to optimized ventilations
 - v. Repeat above until obstruction relieved or intubation equipment prepped
 - vi. Initiate CPR as indicated by patient condition

Advanced Medical Care

1. For unconscious patients with airway obstruction unrelieved by methods outlined above, use laryngoscope to visualize posterior pharynx and larynx
 - A. Remove any observed foreign material with suction or Magill forceps
2. Advanced Airway management as indicated
 - A. [Airway: Intubation Protocol](#)
 - B. [Airway: BIAD Protocol](#)
3. Ensure proper tube placement using capnometry, SpO₂ and ventilate with 100% oxygen
4. Obtain rhythm strip and refer to appropriate protocol as indicated

Additional Considerations

- * Many choking episodes will be resolved prior to EMS arrival on the scene
 - A thorough assessment should be performed on all patients regardless of symptoms
- * Blind finger sweeps without direct visualization of foreign material is contraindicated in all patients
- * Any infant choking episode associated with a period of apnea or cyanosis should be transported regardless of appearance on arrival
- * Choking may be an early sign for stroke onset
- * Aspiration is often associated with a choking episode
- * In situations where a complete obstruction is below the level of the vocal cords, the only option may be to perform intubation via standard technique and advance the endotracheal tube into a mainstem bronchus in effort to advance the foreign body into that bronchus
 - Then withdrawal the endotracheal tube so the distal end is at typical depth within the trachea and ventilate as usual
 - Provider will only be ventilating one lung in this instance, but effective oxygenation and ventilation can still occur utilizing a single lung

Convulsions-Seizures (UP-13)

Introduction

- * Potential causes
 - CNS mass lesions
 - CNS trauma
 - CVA
 - Drug intoxication/overdose
 - Drug withdrawal
 - Eclampsia
 - Epilepsy
 - Fever (age: 6 mos. – 6 years)
 - Hyperthermia
 - Hypoglycemia
 - Hyponatremia
 - Hypotension/Hypertension
 - Hypoxia
 - Infection (meningitis/encephalitis)
 - Metabolic
- * Status epilepticus = continuous seizure activity lasting > 5 minutes or recurrent seizure activity without clearing to normal mental status between episodes

Clinical Presentation

- * Involuntary, non-purposeful, tonic-clonic muscle activity (Grand Mal Seizure)
- * Unconsciousness or inability to respond (Absence or Petit Mal seizure)
- * Breath-holding spells
- * Bowel / Bladder incontinence
- * Focal or generalized
- * Tongue biting
- * Post-ictal confusion

Basic Medical Care

1. [Medical Initial Assessment Protocol](#) or [Pediatric Initial Assessment Protocol](#)
2. Maintain airway; suction as needed
3. Assess vital signs
4. Provide supplemental oxygen per patient condition to maintain SpO₂ = 94 – 97%
5. Provide assisted ventilations with bag-valve mask and 100% oxygen if breathing or ventilatory compromise is apparent
6. Assess blood glucose level
 - A. Oral glucose for hypoglycemia and patient alert with intact gag reflex
7. For patient actively seizing, ensure patient's safety
 - A. Do not attempt to restrain seizure activity
 - B. Protect patient from potential injury by surroundings
8. Allow conscious patients to maintain in position of comfort

Advanced Medical Care

1. Midazolam (Versed®) for actively seizing or status epilepticus
 - A. Adults: 10 mg IM, IN
 - B. Pediatrics: 0.2 mg/kg IM, IN (maximum 10mg)
2. Assess blood glucose level after midazolam (Versed®) administration
 - A. For continued seizure activity 5-minutes after initial midazolam dose and glucose > 60 mg/dL; repeat midazolam (Versed®) administration IM, IN
3. D10 for hypoglycemia
 - B. Adults: D10 @ 100 ml IV, IO
 - i. Reassess mental status/recheck glucose
 - ii. As indicated repeat D10 @ 100 ml IV, IO
 - iii. If unable to establish IV access: glucagon 1 mg IM
 - C. Pediatrics \geq 8 years: D10 @ 5 ml/kg IV, IO (maximum 100 ml)
 - i. Reassess mental status/recheck glucose
 - ii. As indicated repeat D10 @ 5 ml/kg IV, IO (maximum 100 ml)
 - iii. If unable to establish IV access: glucagon 1 mg IM
 - D. Pediatrics: 31 days – 8 years: D10 @ 2 ml/kg IV, IO (maximum 100 ml)
 - i. Reassess mental status/recheck glucose
 - ii. As indicated repeat D10 @ 2 ml/kg IV, IO (maximum 100 ml)
 - iii. If unable to establish IV access: glucagon
 - \leq 20 kg: 0.5 mg IM
 - > 20 kg: 1 mg IM
 - E. Neonates (0 – 30 days of age): D10 @ 2 ml/kg IV, IO
 - i. Reassess/recheck glucose
 - ii. Repeat D10 @ 2 ml/kg IV, IO as indicated per mental status and blood glucose level
4. For suspected eclampsia (patient 20 weeks pregnant or \leq 1-month post-partum):
 - F. Magnesium sulfate 4 grams IV over 15 minutes
 - G. Midazolam (Versed®) 10mg IM, IN
5. Naloxone (Narcan®) for suspected narcotic overdose
 - H. Adults: 2 mg IV, IO, IN
 - I. Pediatrics: 0.1 mg/kg IV, IO, IN (maximum 2 mg)
6. Advanced Airway management as indicated
 - J. [Airway: Intubation Protocol](#)
 - K. [Airway: BIAD Protocol](#)
7. Ensure proper tube placement using capnometry, SpO₂ and ventilate with 100% oxygen
8. Obtain 4-lead ECG and refer to appropriate protocol as indicated
9. For patient with a vagus nerve stimulator (VNS) implanted for refractory seizures
 - A. Place magnet over the VNS for recurrent/continued seizures
 - i. This will turn the VNS on



Additional Considerations

- * Administration of midazolam is indicated for patients actively seizing or in status epilepticus
 - Status = continuous seizure activity for greater than 5 minutes or 2 or more sequential seizures without full recovery of consciousness between episodes
 - Since seizure activity often prompts the 911 call, give midazolam immediately to the patient if they are having continuous seizure activity upon arrival
- * Continuous nasal cannula ETCO₂ monitoring should be utilized following midazolam (Versed®) administration
- * Treatment for status seizures should be initiated on scene with transport initiated as soon as possible
- * Do not force objects into the oral cavity during a seizure or during the post-ictal period
- * Partial seizures may involve muscle twitching in an isolated digit or extremity, various neurological complaints (auditory or visual hallucinations), or repetitive movements (chewing, repetitive hand movements or speech patterns)
- * Complex or generalized seizures are more common and involve full-body movements
- * Partial and complex seizures should be treated the same by administering midazolam and then reassessing as above
- * Suspect cardiac etiology or stroke in patient > 50-years of age with seizure activity

Diabetic Problems (AM-2/PM-2)

Diabetic Ketoacidosis (DKA)

- * Results from inadequate supply of insulin
- * Results in hyperglycemia, osmotic diuresis, dehydration, electrolyte abnormalities, ketone production, and metabolic acidosis
- * Causes:
 - Burns
 - Infection
 - Myocardial infarction
 - Non-compliance
 - Pregnancy
 - Stroke
 - Surgery
 - Trauma
- * Clinical Presentation (DKA)
 - Acidosis
 - Hyperglycemia
 - Hyperkalemia
 - Hypotension
 - Ketonuria
 - Kussmaul respirations
 - Polydipsia
 - Polyuria
 - Tachycardia
 - Tachypnea

Hyperglycemic Nonketotic Hyperosmolar Coma (HDKH)

- * Results from inadequate supply of insulin
- * Results in severe hyperglycemia, hyperosmolality, osmotic diuresis, dehydration without ketone production or acidosis
- * Causes:
 - Same as DKA
- * Clinical Presentation (HDKH)
 - Altered mental status
 - Dehydration
 - Hyperglycemia
 - Hyperosmolality
 - Hypotension
 - Nausea/vomiting
 - Tachycardia

Hypoglycemia

- * Definition: serum glucose < 60 mg/dl
- * Causes:
 - Adrenal insufficiency
 - Hypothermia
 - Inadequate intake
 - Infection (sepsis)
 - Insulinoma
 - Medication overdose
- * Clinical Presentation
 - Altered mental status
 - Coma
 - Diaphoresis
 - Disorientation
 - History of diabetes
 - Hypothermia
 - Lethargy
 - Seizure
 - Tachycardia
 - Tremors

Hypoglycemia

Basic Medical Care

1. [Medical Initial Assessment Protocol](#) or [Pediatric Initial Assessment Protocol](#)
2. Maintain airway; suction as needed
3. Assess vital signs
4. Provide supplemental oxygen per patient condition to maintain SpO₂ = 94 – 97%
5. Provide assisted ventilations with bag-valve mask and 100% oxygen if breathing or ventilatory compromise is apparent
6. Assess blood glucose level
 - A. Oral glucose for hypoglycemia and patient alert with intact gag reflex

Advanced Medical Care

1. D10
 - A. Adults: D10 @ 100 ml IV, IO
 - i. Reassess mental status/recheck glucose
 - ii. Repeat D10 @ 100 ml IV, IO as indicated
 - iii. If unable to establish IV access: glucagon 1 mg IM
 - B. Pediatrics ≥ 8 years: D10 @ 5 ml/kg IV, IO (maximum 100 ml)
 - i. Reassess mental status/recheck glucose
 - ii. Repeat D10 @ 5 ml/kg IV, IO (maximum 100 ml) as indicated
 - iii. If unable to establish IV access: glucagon 1 mg IM
 - C. Pediatrics: 31 days – 8 years: D10 @ 2 ml/kg IV, IO (maximum 100 ml)
 - i. Reassess mental status/recheck glucose
 - ii. Repeat D10 @ 2 ml/kg IV, IO (maximum 100 ml) as indicated
 - iii. If unable to establish IV access: glucagon
 - ≤ 20 kg: 0.5 mg IM
 - > 20 kg: 1 mg IM
 - D. Neonates (0 – 30 days of age): D10 @ 2 ml/kg IV, IO
 - i. Reassess/recheck glucose
 - ii. Repeat D10 @ 2 ml/kg IV, IO as indicated per mental status and blood glucose level
2. Obtain rhythm strip and refer to appropriate protocol as indicated
3. Considers causes of hypoglycemia and treat per appropriate protocol

*** If D10 unavailable:**

- Dilute D50 to D25 (D12.5 for neonates < 30 days old)
 - Adults = D25 @ 50 ml, IV, IO
 - > 8 years = D25 @ 50ml IV, IO
 - 31 days – 8 years = D25 @ 2 ml/kg IV, IO (maximum 50ml)
 - < 30 days old = D12.5 @ 2 ml/kg IV, IO
- Reassess and repeat as indicated based on patient condition and blood glucose level

Hyperglycemia

Basic Medical Care

1. [Medical Initial Assessment Protocol](#) or [Pediatric Initial Assessment Protocol](#)
2. Maintain airway; suction as needed
3. Assess vital signs
4. Provide supplemental oxygen per patient condition to maintain SpO₂ = 94 – 97%
5. Provide assisted ventilations with bag-valve mask and 100% oxygen if breathing or ventilatory compromise is apparent
6. Assess blood glucose level

Advanced Medical Care

1. Adults: normal saline IVF 500 – 1000 ml bolus and reassess
2. Pediatrics: normal saline IVF 10 – 20 ml/kg bolus and reassess
3. Ondansetron (Zofran®) for nausea and/or vomiting
 - A. Adults: 4 – 8 mg IV, IM, PO
 - B. Pediatrics: 0.15 mg/kg IV, IM, PO (maximum 4 mg)
4. Advanced Airway management as indicated
 - A. [Airway: Intubation Protocol](#)
 - B. [Airway: BIAD Protocol](#)
5. Ensure proper tube placement using capnometry, SpO₂, and ventilate with 100% oxygen
6. Considers causes of hyperglycemia and treat per appropriate protocol
7. Obtain 12-lead ECG if patient presentation consistent with DKA
8. Administer calcium gluconate 2 grams IV for ECG changes of suspected hyperkalemia

Additional Considerations

- * Blood glucose should be assessed on all patients with an altered level of consciousness
- * For hypoglycemic patients post treatment and refusing transport ensure the following:
 - Glucose level > 80
 - History of diabetes on insulin therapy
 - Not on oral agents
 - Patient access to food and ability to eat
 - Capacity to make an informed healthcare decision
 - If all the above are not met, contact medical control
- * Patients on oral hypoglycemic agents are at increased risk for recurrent hypoglycemia and therefore should be transported for further evaluation and/or treatment
- * Hyperglycemia resulting in diabetic ketoacidosis may be associated with hyperkalemia
 - This may result in cardiac dysrhythmias, therefore cardiac monitoring is essential in these patients
- * If intravascular access is required for resuscitative purposes and peripheral intravenous lines are unobtainable after two attempts, and glucagon is ineffective, an intraosseous line should be initiated

Hypoglycemic Agents

* Oral agents

Agent	Duration of Action
Glyburide (Diabeta, Micronase, Glynase)	24 hours
Glipizide (Glucotrol)	24 hours
Glimepiride (Amaryl)	> 24 hours
Pioglitazone (Acots)	Unknown
Rosiglitazone (Avandia)	Unknown
Metformin (Glucophage)	Unknown
Acabose (Precose, Prandase)	6 hours
Sitagliptin (Januvia)	24 hours

* Insulins

Agent	Peak	Duration of Action
Regular (Humulin, Novolin)	1 – 2 hours	6 – 8 hours
Lispro (Humalog)	1 – 2 hours	4 – 6 hours
Aspart (NovoLog)	1 – 2 hours	4 – 6 hours
NHP	4 – 6 hours	12 hours
Glargine (Lantus)		12 – 24 hours
Detemir (Levemir)		12 – 24 hours
Novolog 70/30		12 – 24 hours

Submersion-Drowning / Diving Accident (TE-3)

Definitions

- * Fatal drowning = death by suffocation from submersion event
- * Non-fatal drowning = survival, at least temporarily, following suffocation by submersion

Basic Medical Care

1. Confirm scene safety and ensure a protective environment for yourself and the patient
2. For patient still in water, prepare for resuscitation once rescue is affected
 - A. Always ensure that the scene is safe before approaching the patient
 - B. For patient in cool, adverse environment, move to appropriate warmer setting
3. [Medical Initial Assessment Protocol](#) or [Pediatric Initial Assessment Protocol](#)
4. [Trauma Initial Assessment Protocol](#) or [Pediatric Trauma Assessment Protocol](#)
5. Maintain airway; suction as needed
6. Assess vital signs
7. If apneic and pulseless, initiate CPR for the following conditions:
 - A. Submersion time < 30 minutes in all patients
 - B. Submersion time < 45 minutes and water temperature is less than 50° F
 - C. If submersion time unclear initiate resuscitative efforts
8. Provide supplemental oxygen per patient condition to maintain SpO₂ = 94 – 97%
9. Provide assisted ventilations with bag-valve mask and 100% oxygen if breathing or ventilatory compromise is apparent
10. Albuterol 2.5 – 5 mg via nebulizer for respiratory distress related to reactive airway disease
11. Assess blood glucose level
 - A. Oral glucose for hypoglycemia and patient alert with intact gag reflex
12. For suspected trauma to head or spine (history of fall from height, boating or other watercraft accident, diving accident), protect and maintain control of the cervical spine, and the thoracolumbar spine (with manual spinal motion restriction) until cervical collar placed and patient firmly secured to transport stretcher
 - A. Attempt to remove patient from water in a horizontal position
13. Remove appropriate clothing to fully inspect extremities, chest, and abdomen for any significant injuries
 - A. For any illnesses or trauma is noted, refer to appropriate protocol
14. For patient determined to be hypothermic, provide the following:
 - A. Place patient in most comfortable position and remove any wet or damp clothes
 - B. Insulate patient as much as possible with blanket
 - C. Move patient to warm ambulance as soon as possible

Advanced Medical Care

1. Obtain rhythm strip and refer to appropriate protocol as indicated
4. Albuterol via hand held or mask nebulizer for bronchospasm
 - A. Adults: 5 mg
 - B. Pediatrics: 2.5 – 5
 - C. Repeat as indicated per patient condition
5. For persistent respiratory distress:
 - A. CPAP if patient is awake and not responding to above treatment
 - B. Continue albuterol in-line via CPAP as indicated by patient condition
6. For hypoglycemia treat as per [Diabetic Problems Hypoglycemia Protocol](#)
7. Advanced Airway management as indicated
 - A. [Airway: Intubation Protocol](#)
 - B. [Airway: BIAD Protocol](#)
 - C. Ensure proper tube placement using capnometry and SpO₂, and ventilate with 100% oxygen
8. Additional care per appropriate protocol based on patient's presentation

Additional Considerations

- * Consider pre-existing medical condition as precipitant to submersion episode
 - Drug intoxication / overdose
 - Hypoglycemia
 - Seizure
 - Syncope
 - Trauma
- * Intubated patients may likely require elevated levels of PEEP
- * Document length of time under water and temperature of water (if known)
- * Some patients, particularly children, can survive extended periods of submersion in very cold water
 - Even in situations where the patient's pupils were fixed and dilated, and the resuscitation was prolonged, patients have had good clinical outcomes
 - Rewarming techniques must be initiated to achieve core body temperature greater than 86° F before resuscitation can be stopped
- * All non-fatal patients, with or without aspiration, should be transported to the hospital for observation and to evaluate for laryngospasm, pulmonary edema, and Acute Respiratory Distress Syndrome (ARDS)
 - Any submersion event patient should be encouraged re: transport to an ED
- * When using CPAP for non-fatal drowning with possible aspiration, apply positive end-expiratory pressure by starting at 0 cmH₂O of pressure and slowly titrating to achieve a desirable and tolerated positive pressure reading (usually 5-10 cmH₂O; maximum 10 cmH₂O)
- * Foam often is present in airway and may be copious, DO NOT waste time attempting to suction
 - Ventilate with BVM through foam (suction water and vomit only when present)

Electrocution

Current

- * Alternating Current (AC)
 - Lower voltage, household current
 - Flow of electrons switches from positive to negative
 - Tends to cause continuous muscle contraction (tetany), therefore longer exposure
 - Cardiac arrest due to ventricular fibrillation
- * Direct Current (DC)
 - Higher voltage, power lines, lightning
 - Flow of electrons in one direction
 - Tends to cause single muscle spasm, therefore short exposure time and throw victim from the source
 - Cardiac arrest due to asystole

Clinical Presentation

- * Cardiac dysrhythmia
- * Muscle pain
- * Variable wounds (external wounds can NOT be used to estimate extent of injury)

Basic Medical Care

1. Confirm scene safety
2. Ensure a protective environment for yourself and the patient
 - A. For patient still near or in contact with electrical source, prepare for resuscitation once rescue is affected
 - B. Ensure power source is off prior to contact with the patient
3. [Trauma Initial Assessment Protocol](#) or [Pediatric Trauma Assessment Protocol](#)
4. Maintain airway; suction as needed
5. Assess vital signs
6. Provide supplemental oxygen per patient condition to maintain SpO₂ = 94 – 97%
7. Provide assisted ventilations with bag-valve mask and 100% oxygen if breathing or ventilatory compromise is apparent
8. For suspected trauma to head or spine, protect and maintain control of the cervical spine, (with manual motion restriction), and the thoracolumbar spine until cervical collar placed and patient secured to the transport stretcher
9. Remove appropriate clothing to fully inspect for any potential injuries
10. Cover burned skin with a clean, dry sheet
11. Keep patient as warm as possible
12. Splint any long bone deformities or areas where crush injury has occurred
13. Consider additional blunt trauma as suggested by mechanism of injury
14. Acetaminophen (Tylenol®) for pain control
 - A. Adult: 650 – 975mg PO
 - B. Pediatric: 15 mg/kg PO (maximum 650 mg)

Advanced Medical Care

1. Apply cardiac monitor and obtain 4-lead ECG and refer to appropriate protocol as indicated
2. Obtain 12-lead ECG as indicated
3. For ECG changes consistent with hyperkalemia
 - A. Calcium gluconate (10% solution)
 - i. Adult: 2 grams (20ml) IO, IV over 2 minutes
 - ii. Pediatric: 20 mg/kg IO, IV (0.2 ml/kg); maximum 2 grams (20 ml)
 - iii. Repeat in 10 minutes as indicated by patient condition and rhythm
 - B. Sodium bicarbonate
 - i. Adult: 50 mEq (50 ml) IO, IV
 - ii. Pediatric: 1 mEq/kg (1 ml/kg) maximum 50 mEq (50 ml) IO, IV
4. IVF resuscitation
 - A. Adults:
 - i. Hemodynamically unstable: IVF wide open
 - ii. Hemodynamically stable: TKO
 - B. Pediatrics
 - i. Hemodynamically unstable: 10 – 20 ml/kg bolus and reassess
 - ii. Hemodynamically stable: TKO
5. Fentanyl for pain control
 - A. Adults:
 - i. 1 – 2 mcg/kg IN (maximum 200 mcg)
 - ii. 0.5 – 1 mcg/kg IV, IM (maximum 100 mcg)
 - iii. May repeat x1 in 15 minutes as indicated (maximum 100 mcg any route)
 - B. Pediatrics:
 - i. 0.5 – 1 mcg/kg IV, IM, IN (maximum 100 mcg)
 - ii. Contact Medical Control for repeat dosing
6. Alternative analgesic: nitrous oxide via patient-controlled inhalation
7. Advanced Airway management as indicated
 - A. [Airway: Intubation Protocol](#)
 - B. [Airway: BIAD Protocol](#)
8. Ensure proper tube placement using capnometry, SpO₂ and ventilate with 100% oxygen

Additional Considerations - Lightning

- * Some victims who have been struck by lightning and have prolonged cardiac or respiratory arrest have been resuscitated with good clinical outcomes
- * It is imperative to continue ALS care until patient arrives at the hospital
- * Lightning strike should be suspected in all patients found to be confused, unconscious, in respiratory or cardiac arrest, or injured in the appropriate setting and conditions
- * Additional signs & symptoms:
 - Cool pulseless extremities secondary to vasospasm
 - Extremity paralysis/paresthesia
 - Lichtenberg figures [ferning – see below]
 - Tympanic membrane rupture
- * Lightning strike involving multiple patients requires a reverse triaging technique
 - Patients awake, and breathing will not likely experience an acute dysrhythmia
 - Patients who are unresponsive should be evaluated initially and resuscitative measures instituted
- * Typical series of events is cardiac arrest with apnea, patient's heart automaticity often restarts a perfusing rhythm, however neurologic control of breathing centers is delayed, and apnea continues resulting in a secondary cardiac arrest from hypoxia
- * Examples of Lichtenburg lines (ferning) from lightning strike

**Additional Considerations – Electrical shocks**

- * Attempt to ascertain the voltage delivered, current type, duration of exposure, and the suspected pathway of the current through the body (based on entry and exit burns that may or may not be present)
- * Entrance wounds from electrical shocks appear as painless, sharp, well-demarcated, inflammatory lesion
- * Exit wounds are often described as having an “exploded” and more ragged appearance
- * Electrical burns that do not appear to be severe externally may have caused severe damage internally

Eye Problems

Differential Diagnosis

- | | |
|----------------|-----------------------|
| * Allergies | * Infection |
| * CVA | * Trauma |
| * Foreign body | * Vision blurred/loss |
| * Glaucoma | |

Basic Medical Care

1. [Medical Initial Assessment Protocol](#) or [Pediatric Initial Assessment Protocol](#)
2. Maintain airway; suction as needed
3. Assess vital signs
4. Provide supplemental oxygen per patient condition to maintain SpO₂ = 94 – 97%
5. Provide assisted ventilations with bag-valve mask and 100% oxygen if breathing or ventilatory compromise is apparent
6. For suspected trauma to head or spine, protect and maintain control of the cervical spine, (with manual spinal motion restriction), and the thoracolumbar spine until cervical collar placed and patient secured to the transport stretcher
7. For chemical burn, riot control agent exposure, or foreign body in eye, copiously irrigate gently with normal saline
8. For open globe injury or globe protruding/not appropriately in the socket, cover the affected eye with a sterile, moist dressing
 - A. Be sure to NOT apply any direct pressure to the globe
 - B. Then cover uninjured eye
9. For foreign body protruding from the eye, stabilize object as possible and cover both eyes
 - A. Attempts to remove any large foreign body from the eye should not be performed
10. Acetaminophen (Tylenol®) for pain control
 - A. Adults: 650 – 975 mg PO
 - B. Pediatrics: 15 mg/kg PO (maximum 650 mg)

Advanced Medical Care

1. Fentanyl for pain control
 - A. Adults:
 - i. 1 – 2 mcg/kg IN (maximum 200 mcg)
 - ii. 0.5 – 1 mcg/kg IV, IM (maximum 100 mcg)
 - iii. May repeat x1 in 15 minutes as indicated (maximum 100 mcg any route)
 - B. Pediatrics:
 - i. 0.5 -1 mcg/kg IV, IM, IN (maximum 100 mcg)
 - ii. Contact Medical Control for repeat dosing
2. Alternative analgesic: nitrous oxide via patient-controlled inhalation
3. Ondansetron (Zofran®) for nausea and/or vomiting
 - A. Adults: 4 – 8 mg IV, IM, PO
 - B. Pediatrics: 0.15 mg/kg IV, IM, PO (maximum 4 mg)

Additional Considerations

- * When impalement injuries are noted to one eye, both eyes should be covered
 - This limits bilateral or consensual eye movements
 - Ensure that pressure is not being applied to the injured eye by the covering

Do not apply pressure directly to the eye



- * Chemical injuries
 - Bases (lye) cause more severe injuries than acids
 - In both circumstances, the eyes should be flushed gently with copious amounts of normal saline
- * A retinal detachment is a serious threat to the patient's vision, and may or may not result from a traumatic insult
 - The patient may describe seeing flashes of light, floating strands or particles, or a visual field defect described as a shadow or a curtain
 - Detachment is typically not painful
- * Unilateral, transient, painless blurred vision may be the warning sign for impending cerebrovascular accident (amaurosis fugax)
 - Unilateral, painless blindness may be the result of an embolic event to the retinal artery
 - This must be evaluated immediately
- * Acute glaucoma is an emergency
 - Patient will complain of severe pain, headache, blurred vision, halos around lights, and nausea and vomiting
 - Typically dilated pupil with cloudy appearing cornea
 - Blindness may result



Falls / Back Injury

Introduction

- * Consider history of events precedent to fall / back injury
 - Assault/trauma
 - Heavy lifting
 - Hypoglycemia
 - Near syncope/syncope
 - Seizure
 - Slip/trip
 - Vertigo

Basic Medical Care

1. Ensure scene safety
2. [Trauma Initial Assessment Protocol](#) or [Pediatric Trauma Assessment Protocol](#)
3. Maintain airway; suction as needed
4. Control any active bleeding sites with manual direct pressure and/or pressure dressing
5. Assess vital signs
6. Provide supplemental oxygen per patient condition to maintain SpO₂ = 94 – 97%
7. Provide assisted ventilations with bag-valve mask and 100% oxygen if breathing or ventilatory compromise is apparent
8. For suspected trauma to head or spine, protect and maintain control of the cervical spine, (with manual motion restriction), and the thoracolumbar spine until cervical collar placed and patient secured to the transport stretcher
 - A. Assess neurological status before and after motion restriction
9. Remove appropriate clothing to fully inspect extremities, chest, and abdomen for any significant injuries
10. Splint any long bone deformities or areas where crush injury has occurred
 - A. Dislocated joints should be splinted in position of deformity
 - B. Fractures should be realigned and splinted from joint above through joint below
 - C. Distal pulses should be assessed before and after realignment and splinting
11. Apply appropriate dressing to any open wounds
12. Assess blood glucose level as indicated per patient presentation
 - A. Oral glucose for hypoglycemia and patient alert with intact gag reflex
13. Follow the appropriate protocol for any medical cause of fall as identified
14. Acetaminophen (Tylenol®) for pain control
 - A. Adults: 650 – 975 mg PO
 - B. Pediatrics: 15 mg/kg PO (maximum 650 mg)

Advanced Medical Care

1. Obtain 4-lead ECG and refer to appropriate protocol as indicated
2. IVF as per patient condition
 - A. Adults:
 - i. Hemodynamically unstable: IVF wide open
 - ii. Hemodynamically stable: TKO
 - B. Pediatrics
 - i. Hemodynamically unstable: 10 – 20 ml/kg bolus and reassess
 - ii. Hemodynamically stable: TKO
3. Fentanyl for pain control
 - A. Adults:
 - i. 1 – 2 mcg/kg IN (maximum 200 mcg)
 - ii. 0.5 – 1 mcg/kg IV, IM (maximum 100 mcg)
 - iii. May repeat x1 in 15 minutes as indicated (maximum 100 mcg any route)
 - B. Pediatrics:
 - i. 0.5 – 1 mcg/kg IV, IM, IN (maximum 100 mcg)
 - ii. Contact Medical Control for repeat dosing
 - C. Avoid in cases involving exacerbation of chronic back pain
4. Alternative analgesic: nitrous oxide via patient-controlled inhalation
5. For adult with suspected open fracture: cefazolin (Ancef®)
 - A. > 120 kg: 3 grams IV over 3 – 5 minutes
 - B. 40 – 120 kg: 2 grams IV over 3 – 5 minutes
6. Advanced Airway management as indicated
 - A. [Airway: Intubation Protocol](#)
 - B. [Airway: BIAD Protocol](#)
7. Ensure proper tube placement using capnometry, SpO₂ and ventilate with 100% oxygen
8. Follow the appropriate protocol for any medical cause of fall as identified

Additional Considerations

- * Determine if any clinical condition is present that may have led to the fall
 - Chest pain
 - Dizziness
 - Hypoglycemia
 - Syncope
 - Trauma
 - Vertigo
- * Anticipate potential injuries based on the body area sustaining impact
 - Supine impact: central and peripheral skeletal, blunt chest or abdominal injuries
 - Prone impact: central and peripheral skeletal, blunt chest or abdominal injuries
 - Head impact: traumatic brain injury, cervical spine fractures
 - Upright impact: leg, foot, ankle fractures, lumbar and thoracic spine fractures
- * Estimate distance of the fall
- * Some patient populations may sustain significant injury with relatively minor falls
 - Anticoagulation
 - Chronic alcohol abuse
 - Elderly
 - Post-menopausal women
- * Neurogenic shock
 - Signs: Hypotension with bradycardia
 - IVF bolus
 - Dopamine @ 10 – 20 mg/kg/min and titrate to systolic BP > 90 mmHg
- * Patients should have cervical collar placed and transported in supine position firmly secured to the transport stretcher if any of the following are present:
 - Abnormal mental status
 - Intoxicated or under the influence of mind-altering substance
 - Age < 5 years or > 65 years (with any evidence of trauma above the clavicles)
 - Any posterior midline tenderness
 - Presence of distracting injury
 - Cervical pain with cervical range of motion
 - Patient unable to rotate neck 45 degrees to the left and to the right
 - Do NOT assess range of motion if the patient has any midline cervical spine tenderness to palpation
 - Any focal neurological deficit
 - High risk mechanism of injury
 - Fall > 3 feet (5 stairs)
 - Diving injury
- * Long spine boards are intended to be utilized as a patient extrication/movement device and it is not intended for the patient to be transported on a long spine board
- * LSB should be removed once the patient is placed on the transport stretcher

Headache

Differential Diagnosis

- * Brain abscess
- * Brain tumor
- * Cerebrovascular accident
- * Cluster headache
- * Encephalitis
- * Epidural hemorrhage
- * Hypertensive crisis
- * Intracerebral hemorrhage
- * Meningitis
- * Migraine
- * Sinus infection
- * Subarachnoid hemorrhage
- * Subdural hemorrhage
- * Tension headache

Basic Medical Care

1. [Medical Initial Assessment Protocol](#) or [Pediatric Initial Assessment Protocol](#)
2. Maintain airway; suction as needed
3. Assess vital signs
4. Provide supplemental oxygen per patient condition to maintain SpO₂ = 94 – 97%
5. Provide assisted ventilations with bag-valve mask and 100% oxygen if breathing or ventilatory compromise is apparent
6. Acetaminophen (Tylenol®) for pain control
 - A. Adults: 650 – 975 mg PO
 - B. Pediatrics: 15 mg/kg PO (maximum 650 mg)

Advanced Medical Care

1. Apply monitor and obtain rhythm strip and refer to appropriate protocol as indicated
2. CAUTIOUSLY consider fentanyl for pain control (administer acetaminophen as first line)
 - A. Adults:
 - i. 1 – 2 mcg/kg IN (maximum 200 mcg)
 - ii. 0.5 – 1 mcg/kg IV, IM, IO (maximum 100 mcg)
 - iii. May repeat x1 in 15 minutes as indicated (maximum 100 mcg any route)
 - B. Pediatrics:
 - i. 0.5 – 1 mcg/kg IV, IN, IM, IO (maximum 100 mcg)
 - ii. Contact Medical Control for repeat dosing
 - C. Avoid in patients with exacerbation of chronic headaches
3. Ondansetron (Zofran®) for nausea and/or vomiting
 - A. Adults: 4 – 8 mg IV, IM, PO
 - B. Pediatrics: 0.15 mg/kg IV, IM, PO (maximum 4 mg)
4. Advanced Airway management as indicated
 - A. [Airway: Intubation Protocol](#)
 - B. [Airway: BIAD Protocol](#)
5. Ensure proper tube placement using capnometry, SpO₂ and ventilate with 100% oxygen

Additional Considerations

- * Migraine headache
 - Typically, unilateral and described as pounding or throbbing pain
 - Often associated with photophobia or sensitivity to noise or odors
 - Often associated with blurred vision, nausea or vomiting
 - Sometimes preceded by an aura
- * Tension headache
 - Typically, constant band-like pain or pressure
 - Affects the front, top or sides of the head
 - Usually begins gradually, and often occurs in the middle of the day
- * Cluster headache
 - Recurs over a period of time
 - Typically, intense one-sided pain described as having a burning or piercing
 - Usually located behind one eye or in the eye region, without changing sides
 - Persons experience an episode one to three times per day during a period of time (the cluster period), which may last from two weeks to three months
 - Headaches may disappear completely for months or years, only to recur
 - Often respond to high flow oxygen via non-rebreather
- * Sinus infection headache
 - Typically associated with a deep and constant pain in the cheekbones, forehead, or bridge of the nose
 - Pain usually intensifies with sudden head movement or leaning forward
 - Usually accompanied by nasal discharge, fever, and/or facial swelling
- * Subarachnoid hemorrhage
 - Classically presents as a sudden onset of “the worst headache of my life”
 - Usually caused by ruptured aneurysm
 - May occur as the result of head trauma
 - Often associated with nausea or vomiting
 - May present with photophobia, altered mental status, or focal neurologic deficit
- * Meningitis, encephalitis, brain abscess
 - Associated symptoms of include sudden fever, headache, vomiting, photophobia, stiff neck, confusion, impaired judgment, and/or altered mental status
 - Necessary precautions should be considered
- * Epidural, subdural hemorrhage
 - Result of head trauma (subdural may occur with minor head trauma in patients on anticoagulation)
 - Epidural: classically loss of consciousness, a lucid interval, then decline in mental status as hemorrhage enlarges
 - Subdural: may be slowly progressive or associated with rapid symptoms; typically older patients; may present with frequent falls

Heart Problems

Differential Diagnosis

- * Angina
- * Aortic dissection
- * Asthma
- * Cardiac arrest
- * Chest wall injury
- * Cocaine abuse
- * Congenital heart abnormality
- * COPD
- * Esophageal spasm
- * Electrolyte abnormality
- * GI pathology
- * Marijuana abuse
- * Methamphetamine abuse
- * Musculoskeletal pain
- * Myocardial infarction
- * Pericarditis
- * Pneumothorax
- * Pulmonary embolus

Considerations

- * History
 - Age
 - Cardiac risk factors
 - Medications
 - Onset of discomfort
 - Provocation/relief
 - Social history
- * Signs and symptoms
 - Chest pain
 - Chest pressure, tightness,
 - Diaphoresis
 - Jaw pain
 - Nausea/vomiting
 - Shortness of breath, dyspnea

Basic Medical Care

1. [Medical Initial Assessment Protocol](#) or [Pediatric Initial Assessment Protocol](#)
2. Maintain airway; suction as needed
3. Assess vital signs
4. Provide supplemental oxygen per patient condition to maintain SpO₂ = 94 – 97%
5. Provide assisted ventilations with bag-valve mask and 100% oxygen if breathing or ventilatory compromise is apparent
6. Additional care as per specific presumptive diagnosis, patient condition, cardiac disorder

Advanced Medical Care

1. Obtain 4-lead ECG and refer to appropriate protocol as indicated
2. Obtain 12-lead ECG
 - A. Scene to ECG time should be < 8 minutes
3. Additional care per specific entity
4. Advanced Airway management as indicated
 - A. [Airway: Intubation Protocol](#)
 - B. [Airway: BIAD Protocol](#)
5. Additional Care as per specific presumptive diagnosis, patient condition, cardiac disorder

Chest Pain Considered due to Myocardial Ischemia (AC-4)

Basic Medical Care

1. Aspirin 324 mg PO
2. Nitroglycerin 0.4 mg SL (EMT may administer if patients prescribed nitroglycerin)
 - A. Repeat 0.4 mg SL every 5 minutes until pain resolves
 - B. Hold for SBP < 100 mm Hg

Advanced Medical Care

1. ECG: normal or non-specific ST-segment/T-wave changes, or ST-segment depression of > 1 mm in two or more contiguous leads (inferior, septal, anterior, or lateral)
2. For patient unable to tolerate SL nitroglycerin, apply nitro paste to upper chest
 - A. SBP > 200 mm Hg: apply 2 inches
 - B. SBP 150 – 200 mm Hg: apply 1.5 inches
 - C. SBP 100 – 150 mm Hg: apply 1 inch
 - D. Hold/remove for SBP < 100 mm Hg
3. Fentanyl for pain control if pain persists following 2 doses of nitroglycerin
 - A. 1 – 2 mcg/kg IN (maximum 200 mcg)
 - B. 0.5 – 1 mcg/kg IV, IM (maximum 100 mcg)
 - C. May repeat x1 in 15 minutes as indicated (maximum 100 mcg any route)
4. IVF as per patient condition
 - A. Hemodynamically unstable: IVF wide open
 - B. Hemodynamically stable: TKO
5. Ondansetron (Zofran®) for nausea and/or vomiting
 - A. Adults: 4 – 8 mg IV, IM, PO
6. Advanced Airway management as indicated
 - A. [Airway: Intubation Protocol](#)
 - B. [Airway: BIAD Protocol](#)

Additional Considerations

- * Patients with suspected cardiac chest pain should have the 12-lead ECG performed immediately while on the scene
- * Any patient > of 30-years of age with chest pain or any patient with a recent history of cocaine or crack use with chest pain should be considered at risk for cardiac disease
 - These patients should have a 12-lead ECG performed
- * Female, geriatric, and patients with diabetes with myocardial ischemia (or infarction) often present with atypical symptoms and not frank chest pain
 - Dyspnea, weakness/fatigue, jaw pain
- * Patients considered to have an Acute Coronary Syndrome should have aspirin and nitroglycerin administered immediately and transport performed expeditiously
- * Nitroglycerin is contraindicated for any patient who has taken sildenafil (Viagra®), tadalafil (Cialis®), or vardenafil (Levitra®) within the past 24 hours

Chest Pain Considered due to Myocardial Infarction (AC-4)

Advanced Medical Care

1. ECG
 - A. ST-segment elevation > 1 mm in two or more continuous leads (inferior, septal, anterior, or lateral)
 - B. R-wave and ST-segment depression in V1, V2 suggesting posterior MI
 - C. Computer ECG interpretation reports **“***STEMI***”**
2. Repeat ECG as indicated per patient presentation / change in presentation
3. Aspirin 324 mg PO
4. Nitroglycerin 0.4 mg SL
 - A. Repeat 0.4 mg SL every 5 minutes until pain resolves
 - B. Hold for SBP < 100 mm Hg
 - C. EMT may administer to patients with a current prescription for nitroglycerin
5. For patient unable to tolerate SL nitroglycerin, apply nitro paste to upper chest
 - A. SBP > 200 mm Hg: apply 2 inches
 - B. SBP 150 – 200 mm Hg: apply 1.5 inches
 - C. SBP 100 – 150 mm Hg: apply 1 inch
 - D. Hold/remove for SBP < 100 mm Hg
6. Fentanyl for pain control if pain persists following 2 doses of nitroglycerin
 - A. 1 – 2 mcg/kg IN (maximum 200 mcg)
 - B. 0.5 – 1 mcg/kg IV, IM (maximum 100 mcg)
 - C. May repeat x1 in 15 minutes as indicated (maximum 100 mcg any route)
7. Establish IV access
 - A. LEFT arm preferred as catheterization often performed via right radial artery
8. IVF resuscitation
 - A. Hemodynamically unstable: IVF wide open
 - B. Hemodynamically stable: TKO
9. Consider placing defibrillation/pacing pads on patient
 - A. Should be placed on all patients with an anterior or septal STEMI
 - These patients are at increased risk of heart blocks necessitating TCP
10. Lidocaine 1.5 mg IV for significant ventricular ectopy:
 - A. Repeat lidocaine 0.5 mg /kg IV every 5 minutes for dysrhythmia that continues until dysrhythmia resolves or a total of 3 mg/kg has been administered
11. Contact Medical Control at destination PCI hospital for notification of **CODE STEMI** as soon as STEMI is identified (prior to scene departure)

Additional Considerations

- * During the radio report to medical control, the ECG interpretation should be verbalized
 - The paramedic interpretation should be reported & emphasized if STEMI
- * ECG findings which warrant discussion with medical control at a PCI facility (see below)
 - **aVR ST-segment elevation with widespread ST depression**
 - Suggestive of multi-vessel or left main coronary artery disease
 - Patient should be transport to a PCI facility
 - Even though NOT a code STEMI, should be transported to a PCI center
 - **DeWinter T-wave**
 - Anterior STEMI equivalent without obvious ST segment elevation
 - Tall, prominent, symmetrical T waves in precordial leads
 - Upsloping ST segment depression > 1mm at the J point in precordial leads
 - Absence of ST elevation in the precordial leads
 - **Modified Sgarbossa Criteria Left bundle branch block (LBBB) or Paced**
 - New LBBB does NOT equal STEMI
 - Concordant ST elevation > 1mm in leads with positive QRS
 - Concordant ST depression in lead V1 – V3
 - *Proportionally* excessive discordant STE in ≥ 1 lead anywhere with ≥ 1 mm STE, as defined by ≥ 25% of the depth of the preceding S-wave
 - ECG should be faxed to and discussed with medical control physician
 - **Wellens' syndrome**
 - Biphasic or deep inverted T-wave V2 – V3; potential proximal LAD disease
- * Chest pain is the most common manifestation of acute MI
 - May be described as burning, heavy, pain, pressure, squeezing, or tightness
- * 12-lead ECG assessment
 - Inferior – leads II, III, aVF
 - Septal – leads V1, V2
 - Anterior – leads V3, V4
 - Lateral – leads V5, V6, I, aVL
 - Posterior – leads V1, V2, V3
- * Patients with myocardial chest pain & 12-lead ECG that reflects > 1 mm of ST-segment elevation in > 2 contiguous precordial leads, should be transported immediately
 - Scene to ECG time should be < 8 minutes
 - Total scene time should be < 15 minutes
- * An on-scene 12-lead ECG that is interpreted as normal or unremarkable should never be used to convince a patient that their condition is stable
 - 50% of acute myocardial infarctions will initially present with an unremarkable ECG (non-ST elevation MI)
- * Patients with an inferior MI are at risk for right ventricle infarct and nitroglycerin should be used with caution as patients are prone to develop hypotension
 - Nitroglycerin is NOT contraindicated, but increased caution must be used
 - Inferior infarctions typically require normal saline IVF boluses

Special ECG Considerations

* aVR Sign

- aVR ST elevation with widespread ST depression

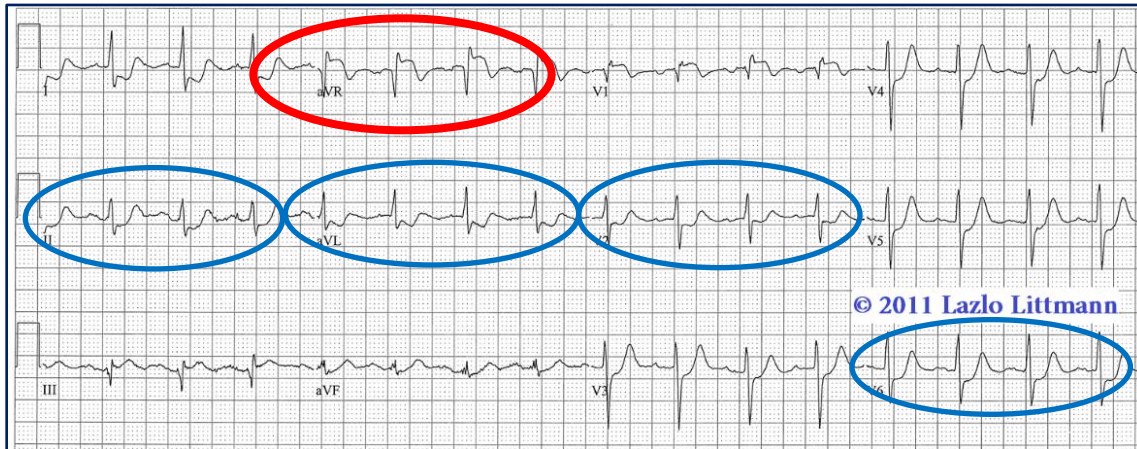

* DeWinter T-wave

- Tall, prominent, symmetrical T waves with upsloping ST segment depression in precordial leads

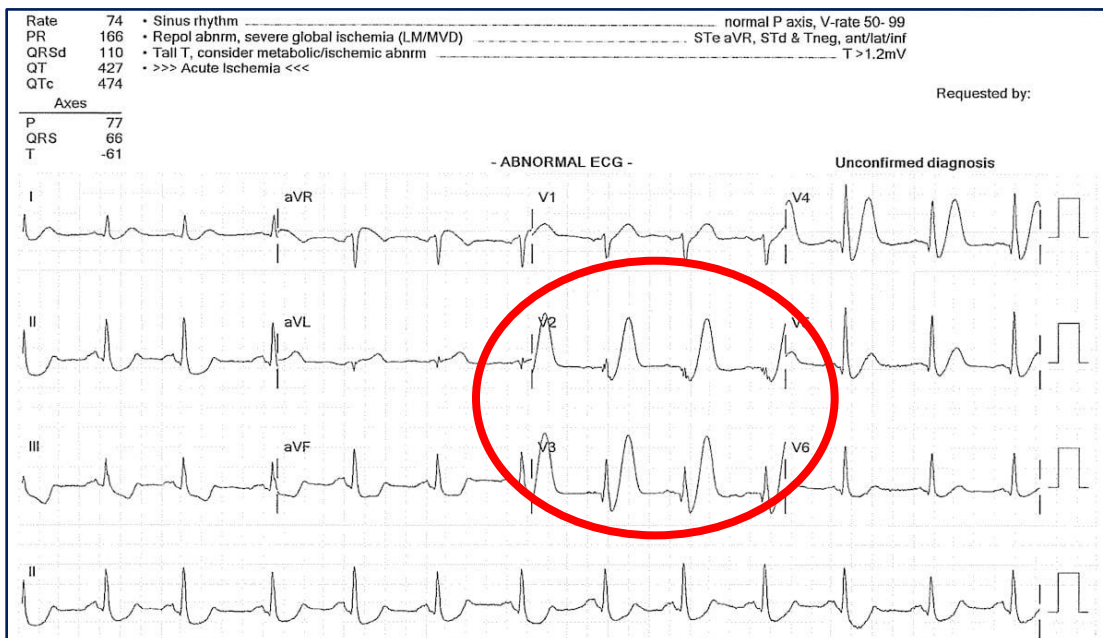

* Modified Sgarbossa criteria

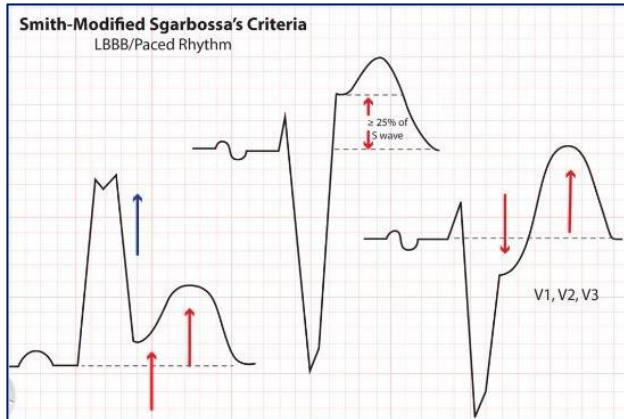

Concordant ST elevation > 1mm in leads with positive QRS

Concordant ST depression in lead V1 – V3

Discordant ST elevation \geq 25% of the depth of the preceding S-wave

* Wellens' criteria

- Biphasic or deep inverted T-wave V2 – V3

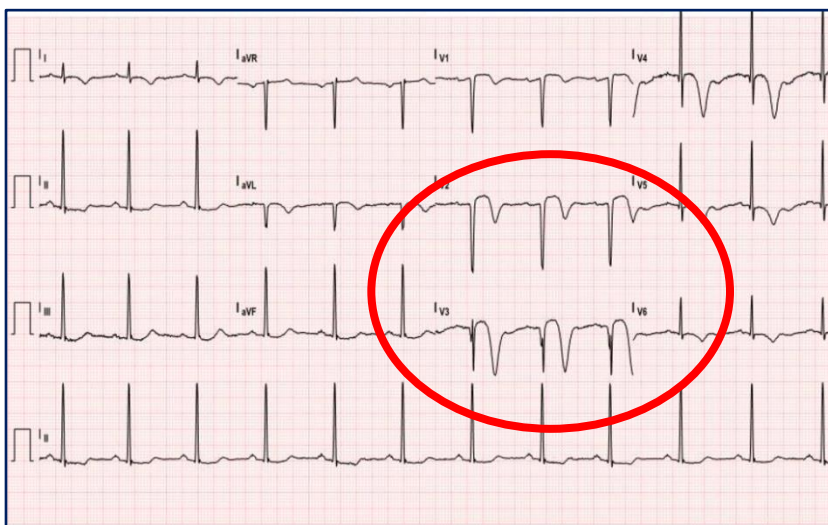
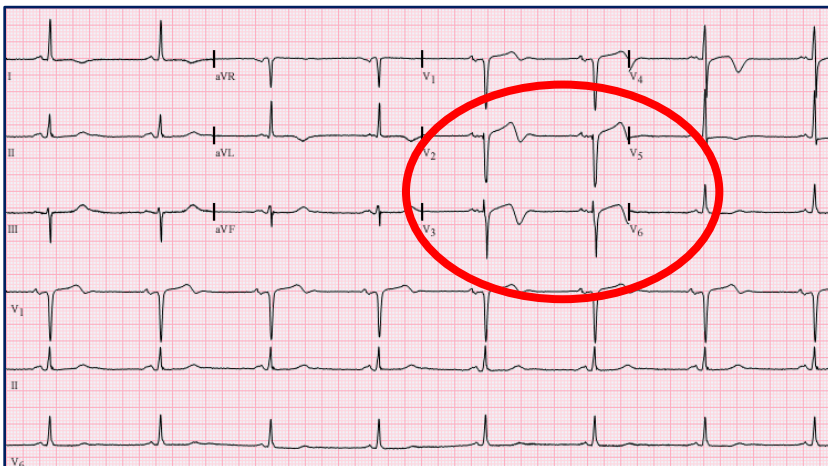

Chest Pain Associated with Cocaine Use

Advance Medical Care

1. Obtain 12-lead ECG with further management as per interpretation
2. IVF: 500 – 1000 ml bolus
3. Midazolam (Versed®) 5 mg IV, IM or 10 mg IN
4. Reassess with repeat treatment as indicated

Additional Considerations

- * Patients must also be evaluated for risk factors for coronary artery disease unrelated to cocaine usage
 - Age
 - Diabetes
 - Family history
 - Hypercholesterolemia
 - Hypertension
 - Known coronary artery disease
 - Smoking
- * Patients at risk for coronary artery disease should be treated as any patient with suspected myocardial ischemia
 - Aspirin 324 mg PO
 - Nitroglycerin 0.4 mg SL
 - Repeat 0.4 mg SL every 5 minutes until pain resolves
 - Hold for SBP < 100 mm Hg
 - EMT may administer to patients with a current prescription for nitroglycerin
 - For patient unable to tolerate SL nitroglycerin, apply nitro paste to upper chest
 - SBP > 200 mm Hg: apply 2 inches
 - SBP 150 – 200 mm Hg: apply 1.5 inches
 - SBP 100 – 150 mm Hg: apply 1 inch
 - Hold/remove for SBP < 100 mm Hg

Supraventricular Tachycardia – Stable (AC-6/PC-5) [Including undifferentiated REGULAR wide complex]

SVT (Narrow) Differential Diagnosis

- | | |
|---|---------------------------------|
| * Sinus tachycardia | * Atrial fibrillation |
| * AV-Nodal reentrant tachycardia ("PSVT") | * Atrial flutter |
| | * Multifocal atrial tachycardia |

Advanced Medical Care

1. Obtain 4-lead ECG
2. Obtain 12-lead as indicated
3. Adult: perform vagal maneuvers
 - A. Valsalva maneuver
 - i. Breath holding and bearing down or have patient blow into syringe
 - B. Modified Valsava maneuver:
 - i. Have patient blow into a syringe while witting upright for 10-15 seconds
 - ii. Quickly lay patient supine and passively elevate legs 45 degrees
4. Adenosine (Adenocard®) – ensure monitor recording strip is printing
 - A. Adults:
 - i. 6 mg IV rapid push followed by saline flush
 - Transport and monitor if rhythm converts
 - ii. 12 mg IV rapid push followed by saline flush if SVT continues and no AV-block was achieved with previous dose
 - Transport and monitor if rhythm converts
 - iii. 12 mg IV rapid push followed by saline flush if SVT continues and no AV-block was achieved with previous dose
 - Transport and monitor if rhythm converts
 - iv. If no conversion occurs but AV block was achieved, assess underlying rhythm evident during AV block and treat per appropriate protocol
 - B. Pediatrics:
 - i. 0.1 mg/kg IV (maximum 6 mg) rapid push followed by saline flush
 - Transport and monitor if rhythm converts
 - ii. 0.2 mg/kg IV (maximum 12 mg) rapid push followed by saline flush if SVT continues and no AV-block was achieved with previous dose
 - Transport and monitor if rhythm converts
 - iii. 0.2 mg/kg IV (maximum 12 mg) rapid push followed by saline flush if SVT continues and no AV-block was achieved with previous dose
 - Transport and monitor if rhythm converts
 - iv. If no conversion occurs but AV block was achieved, assess underlying rhythm evident during AV block and treat per appropriate protocol
5. Additional care as per specific rhythm protocol
6. If any rhythm change occurs refer to appropriate protocol
7. Contact Medical Control if rhythm fails to convert following 3rd dose of adenosine

Supraventricular Tachycardia – Unstable (AC-6/PC-5)

1. Midazolam (Versed®) sedation as patient status permits
 - A. Adult:
 - i. 5 mg IV, IM or 10 mg IN
 - B. Pediatrics:
 - i. 0.15 mg/kg IV, IM (max 5 mg) or 0.2 mg/kg IN (max 10 mg)
2. Fentanyl for pain control as patient status permits
 - A. Adult: 0.5 – 1 mcg/kg IV, IO, IN (maximum 100 mcg)
 - B. Pediatric: 0.5 – 1 mcg/kg IV, IO, IN (maximum 100 mcg)
3. Synchronized cardioversion
 - A. Adults:
 - i. 50 Joules
 - ii. 100 Joules if dysrhythmia continues
 - iii. 150 Joules if dysrhythmia continues
 - Initial setting for unstable atrial fibrillation
 - B. Pediatrics:
 - i. 0.5 J/kg
 - ii. 1 J/kg if dysrhythmia continues
 - iii. 2 J/kg if dysrhythmia continues
4. Contact Medical Control if dysrhythmia persists following above treatment

Additional Considerations

- * Do **NOT** administer adenosine to any heart transplant patient
- * Diltiazem may be harmful in patients with a history of pre-excitation syndromes (WPW)
- * Judicious use of cardioversion should be used in patients currently on digitalis or digoxin
- * Contact medical control prior to attempting cardioversion in a patient who has been in chronic atrial fibrillation (> 48^o) without therapeutic anticoagulation as restoration of normal sinus rhythm increases the risk for embolization in this patient group
- * Sedation with midazolam (Versed®) & fentanyl should be attempted before cardioversion unless the patient is extremely unstable or unconscious
- * If cardioversion performed, ensure equipment for airway management readily available
- * Rapid ventricular response with possible accessory pathway conduction that is irregular & wide complex or polymorphic (WPW with atrial fib) do **NOT** treat with adenosine, beta blockers, or calcium channel blockers which may increase conduction through the accessory pathway
 - If unstable – synchronized cardioversion @ 150 Joules
 - If unable to synchronize – defibrillate @ 150 Joules
- * Supraventricular tachycardia is the most common dysrhythmia causing cardiovascular instability during infancy
 - Supraventricular tachycardia with aberrant conduction that produces a wide complex tachycardia is rare in infants and children
 - Wide complex tachycardia should be treated as ventricular in origin
- * In older children, may consider Valsalva while setting up for more aggressive therapy

Atrial Fibrillation or Atrial Flutter with RVR (AC-6)

Advanced Medical Care

Stable

1. Obtain 4-lead ECG
2. Obtain 12-lead ECG as indicated
3. Adults:
 - A. Diltiazem (Cardizem®) 15 mg IV over 2 minutes
 - B. For no response within 15 minutes: diltiazem (Cardizem®) 20 mg IV over 2 minutes
2. For no response: contact Medical Control
3. IVF: TKO

Unstable

1. Obtain 4-lead ECG
2. Obtain 12-lead ECG as indicated
3. Adults:
 - A. Midazolam (Versed®) 5 mg IV, IM or 10 mg IN
 - B. Fentanyl for pain control as patient status permits
 - i. 0.5 – 1 mcg/kg IV, IO, IN (maximum 100 mcg)
 - C. Synchronized cardioversion
 - i. Atrial fibrillation: @ 150 Joules
 - ii. Atrial flutter: @ 50 Joules
 - D. Contact medical control prior to attempting cardioversion in a patient who has been in chronic atrial fibrillation (> 48^o) without therapeutic anticoagulation
 - i. Restoration of normal sinus rhythm increases the risk for embolization in this patient group
4. IVF for hypotension: wide open
5. For unstable dysrhythmia that continues perform synchronized cardioversion @ 150 Joules
6. If any rhythm change occurs refer to appropriate protocol
7. Contact Medical Control for rhythm fails to convert

Additional Considerations

- * Signs of instability
 - Acute congestive heart failure
 - Altered mental status
 - Hypotension
 - Ischemic chest pain
 - Seizure
 - Syncope

Bradycardia (AC-2/PC-2)

Advanced Medical Care

Symptomatic sinus bradycardia or Type-I 2nd heart block

1. Obtain 4-lead ECG
2. Obtain 12-lead ECG as indicated
3. Ensure adequate oxygenation
4. Adults:
 - A. Atropine 0.5 mg IV, IO
 - B. Repeat atropine 0.5 mg IV every 5 minutes until dysrhythmia resolves or total dose of 3 mg (or 0.04 mg/kg) has been administered
 - i. Hold if occurs in the setting of acute MI and wide-complex rhythm
 - ii. Hold if occurs in the setting of cardiac transplantation
5. Pediatrics:
 - A. Epinephrine (1:10,000) 0.01 mg/kg (0.1 ml/kg) IV, IO
 - B. Atropine 0.02 mg/kg IV, IO (minimum 0.1 mg, max 0.5 mg)
 - C. Repeat atropine 0.02 mg/kg IV, IO (minimum 0.1 mg, max 0.5 mg) in 5 minutes x1 additional dose
 - D. Initiate CPR for continued bradycardia and heart rate < 60 bpm
6. IVF as indicated per patient hemodynamics
 - A. Adults: IVF wide open
 - B. Pediatrics: 10-20 ml/kg bolus
7. Consider dopamine 10 – 20 mcg/kg/min IV, IO

Type-II 2nd degree or 3rd degree heart block

1. Ensure adequate oxygenation
2. Obtain 4-lead ECG
3. Obtain 12-lead ECG as indicated
4. Adult:
 - A. Midazolam (Versed®) 5 mg IV, IM or 10 mg IN
 - B. Transcutaneous pacing per [Cardiac: External Pacing Protocol](#)
 - C. Dopamine @ 10 – 20 mcg/kg/min IV, IO for continued hypotension
 - D. Calcium gluconate 2 grams (20 ml of 10% solution) for continued hemodynamically unstable and patient on calcium channel blocker medication
5. Pediatric:
 - A. Midazolam 0.15 mg/kg IV, IM (max 5 mg) or 0.2 mg/kg IN (max 10 mg)
 - B. Transcutaneous pacing per [Cardiac: External Pacing Protocol](#)
 - C. Initiate CPR for continued bradycardia & heart rate < 60 bpm
 - D. Dopamine @ 10 – 20 mcg/kg/min IV, IO for continued hypotension

Additional Considerations

- * Asymptomatic sinus bradycardia and/or first-degree heart block does not require any treatment
- * Symptoms necessitating treatment
 - Altered mental status
 - Hypotension
 - Ischemic chest pain
 - Syncope
- * Always consider early application of pacing pads in elderly patients having bradycardic rhythms
- * Any patient noted to be hemodynamically unstable and in Type II second degree or third-degree heart block should be paced immediately
 - Provide sedation and analgesia in patients undergoing transcutaneous pacing
- * 2° AVB type II and 3° AVB may deteriorate to asystole
 - Lidocaine is contraindicated with these blocks
- * Patients at risk for brady-dysrhythmias
 - Anterior MI
 - Inferior MI
 - Patients taking: beta-blockers, calcium channel blockers, or digoxin
- * Consider treatable causes for bradycardia
 - Beta Blocker OD
 - Calcium Channel Blocker OD
- * Hypoxia is a common etiology for symptomatic bradycardia in children, therefore, attention to airway and oxygenation is of paramount importance
- * Sinus bradycardia is a common pre-terminal event in children, therefore attention to airway and oxygenation is of paramount importance
- * Most maternal medications pass through breast milk to the infant so maintain high-index of suspicion for OD-toxins
- * Hypoglycemia, severe dehydration and narcotic effects may produce bradycardia
 - Many agents a child ingests can cause bradycardia, often in a single dose

Wide Complex Tachycardia (VT) (AC-7)

Advanced Medical Care

1. Obtain 4-lead ECG
2. Obtain 12-lead ECG as indicated

Stable

1. Adult:
 - A. Lidocaine 1.5 mg/kg IV, IO
 - B. Repeat lidocaine 0.5 mg/kg IV, IO every 5 minutes for ventricular tachycardia that continues until tachycardia resolves or total of 3 mg/kg has been given
 - C. Magnesium sulfate 2 grams IV, IO over 2 minutes for ventricular tachycardia that continues or is polymorphic
2. Pediatric:
 - A. Lidocaine 1 mg/kg IV, IO
 - B. Repeat lidocaine 0.5 mg/kg IV, IO every 5 minutes for ventricular tachycardia that continues until tachycardia resolves or total of 3 mg/kg has been given
3. For any rhythm change occurs refer to appropriate protocol

Unstable (with a pulse)

1. Adults:
 - A. Midazolam (Versed®): 5 mg IV, IM; 10 mg IN
 - B. Fentanyl: 1 mcg/kg IV, IO, IN (max 100 mcg) as patient condition permits
 - C. Synchronized cardioversion @ 100 Joules
 - D. For ventricular tachycardia that resolves: lidocaine 1.5 mg/kg IV, IO
 - E. Repeat cardioversion @150 Joules for VTach that continues
 - F. Magnesium sulfate 2 grams IV, IO over 2 minutes for ventricular tachycardia that continues or is polymorphic
 - G. For ventricular tachycardia that is polymorphic (Torsades) or monitor cannot synchronize, perform defibrillation @ 150 Joules
 - i. Magnesium sulfate 2 grams IV
 - H. Contact Medical Control
2. Pediatric:
 - A. Midazolam: 0.15 mg/kg IV, IM (max 5 mg) or 0.2 mg/kg IN (max 10 mg)
 - B. Fentanyl: 1 mcg/kg IV, IO, IN (max 100 mcg) as patient condition permits
 - C. Synchronized cardioversion @ 0.5 J/kg
 - D. For ventricular tachycardia resolves: lidocaine 1 mg/kg IV, IO
 - E. Repeat cardioversion @ 1 Joules/kg for VT that continues
 - F. Repeat cardioversion @ 2 Joules/kg for VT that continues
 - G. For ventricular tachycardia that is polymorphic (Torsades) or monitor cannot synchronize, perform defibrillation @ 4 Joules/kg (maximum 150 Joules)
 - i. Magnesium sulfate 50 mg/kg IV (maximum 2 grams)
 - H. Contact Medical Control
3. For any rhythm change occurs refer to appropriate protocol

Wide-complex, prolonged QT-interval, or sine-wave consistent with hyperkalemia

1. Adult:
 - A. Calcium gluconate 2 grams (20 ml of 10% solution) IV over 2 minutes
 - B. Repeat calcium gluconate 2 grams for dysrhythmia that continues
 - C. Sodium bicarbonate 50 mEq (50 ml) IV, IO
 - D. Albuterol 5 mg via nebulizer
2. Pediatric:
 - A. Calcium gluconate 20 mg/kg IO, IV (0.2 ml/kg of 10% solution); maximum 2 grams (20 ml) over 2 minutes
 - B. Albuterol 2.5 – 5 mg via nebulizer
3. If any rhythm change occurs refer to appropriate protocol

Additional Considerations – Dysrhythmias

- * When ventricular escape beats are observed in the presence of bradycardia, do not treat with lidocaine
 - Escape beats are attempting to sustain the patient
 - Treat the bradycardia with atropine
- * If unable to differentiate the rhythm between supraventricular and ventricular, treat as ventricular
- * Bolus of lidocaine is more efficacious and safer than lidocaine drips in suppressing ventricular ectopy
- * Prophylactic lidocaine therapy is NOT indicated for routine use when PVC's are associated with acute MI
- * Any dysrhythmia can provoke a pulmonary edema/CHF exacerbation in a patient with a compromised heart
 - Treat the dysrhythmia first
 - For patient that demonstrates signs of respiratory distress and is determined to be in congestive heart failure or pulmonary edema, obtain 12-lead ECG on-scene
 - For acute injury or infarction noted, immediately transport
- * Patients with a history of congestive heart failure, liver disease, shock, or advanced age (>70 years old) should receive half (0.75 mg/kg) the normal bolus of lidocaine
 - Repeat doses should be reduced to 0.5 mg/kg
- * Consider hypoglycemia in any patient progressing into cardiac arrest
 - Consider D10 @ 25 grams (100 ml) IV, IO
- * Magnesium sulfate is contraindicated in patients with renal insufficiency or on dialysis except in cases of Torsades
- * Hyperkalemia is a dangerous electrolyte abnormality and can lead to peaked T-waves, PR segment prolongation, absent p-waves, widening QRS interval, and heart blocks
 - Causes include renal failure, noncompliance with dialysis, acidosis, medications, and significant crush or burn injuries
 - Calcium gluconate and sodium bicarbonate are emergently required as treatment

Congestive Heart Failure (AC-5/PC-3)

Differential Diagnosis

- * Anaphylaxis
- * Aspiration
- * Asthma
- * Congestive Heart Failure
- * Myocardial Infarction
- * Pericardial effusion/tamponade
- * Pleural effusion
- * Pneumonia
- * Pulmonary embolus
- * Toxic exposure

Advanced Medical Care

1. Obtain 4-lead ECG and refer to appropriate protocol as indicated
2. Obtain 12-lead ECG
3. Adult:
 - A. Nitroglycerin 0.4 mg SL
 - i. Hold for SBP < 100 mm Hg
 - B. For patient unable to tolerate SL nitroglycerin, apply nitro paste to upper chest
 - i. SBP > 200 mm Hg: apply 2 inches
 - ii. SBP 150 – 200 mm Hg: apply 1.5 inches
 - iii. SBP 100 – 150 mm Hg: apply 1 inch
 - iv. Hold/remove for SBP < 100 mmHg
 - C. CPAP per [Respiratory: NIPPV Protocol](#), for patient awake and has not responded to above measures
4. Pediatric:
 - A. Position patient with head of bed elevated 30-45°
 - B. Consider placing patient with hips and knees flexed
5. For cardiogenic shock:
 - A. Adults: Dopamine @ 10 – 20 mcg/kg/min IV
 - B. Pediatrics: Dopamine @ 10 – 20 mcg/kg/min IV
 - C. Discontinue CPAP if already instituted

Additional Considerations

- * Any patient noted to be in congestive heart failure should be considered at risk for coronary artery disease
 - Consideration should be given as to the etiology (ischemia/infarction, dysrhythmia)
- * When hypotension is present in patients suspected of being in congestive heart failure, judicious use of IV fluid is important
 - Dopamine may be considered as initial intervention in these instances
- * Pediatric patient considerations
 - Tetralogy of Fallot, transposition of the great arteries, coarctation of the aorta, ventricular septal defects, atrial septal defects, myocarditis, pericarditis, SVT

Left Ventricular Assist Device (LVAD) (AC14)

Introduction

- * Left Ventricular Assist Device (LVAD's) are placed in patients with severe heart failure
 - Most are awaiting heart transplantation
- * There are internal components (connected to the heart) and external components (batteries, drive-line, controller device)
- * Several types exist
 - Patients should have documentation of the type of their LVAD
 - Contact numbers for coordinator for assistance with management
 - Both patient and at least one family member is extensively educated on LVAD system and alarms before discharge from the hospital
- * Patients may or may not have a palpable pulse
 - Non-pulsatile device (Heartmate II) = may NOT have a pulse and BP may only be measurable via Doppler
 - Pulsatile device (HeartMate III or Total Artificial Heart) = will have a pulse and measurable BP
- * All LVADs are preload dependent, give fluids as needed for hypotension
- * Potential complications include:
 - Bleeding
 - Dysrhythmia
 - Hemolysis
 - Infection
 - Pump failure
 - Thrombosis
- * LVAD patients are anti-coagulated
 - May present with GI bleeding or other significant hemorrhage
- * Ensure both batteries are NEVER disconnected at the same time

Patients with an LVAD or TAH will have a coordinator and their contact information. The coordinator may a resource for device troubleshooting or other recommendations as indicated.

Left Ventricular Assist Devices

HeartMate III (pulsatile flow)



HeartMate II (continuous flow non-pulsatile)



HeartMate XVE (pulsatile)

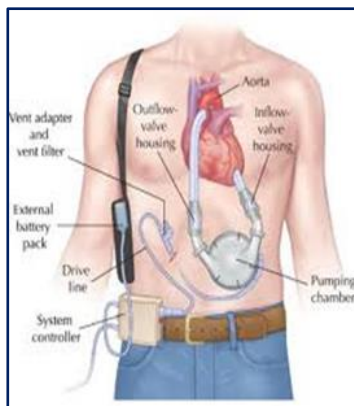

Basic Medical Care

1. [Medical Initial Assessment Protocol](#) or [Pediatric Initial Assessment Protocol](#)
2. Maintain airway; suction as needed
3. Assess level of consciousness
 - A. Patient may be awake and alert despite no palpable pulse
 - i. May or may not have a palpable pulse at baseline
 - ii. Do not rely on pulses to determine if patient has had a cardiac arrest
 - iii. Check to see if patient is breathing, if breathing NO CPR
 - B. If unconscious, pulseless, and apneic
 - i. Initiate focused cardiac arrest protocol and apply AED
 - ii. Do NOT place pads directly over LVAD
4. Assess vital signs
5. Provide supplemental oxygen per patient condition to maintain SpO₂ = 94 – 97%
6. Provide assisted ventilations with bag-valve mask and 100% oxygen if breathing or ventilatory compromise is apparent
7. Additional care as per specific presumptive diagnosis, patient condition, cardiac disorder

Advanced Medical Care











1. Obtain 4-lead ECG as indicated and refer to appropriate protocol
2. Obtain 12-lead ECG as indicated
3. Advanced Airway management as indicated
 - A. [Airway: Intubation Protocol](#)
 - B. [Airway: BIAD Protocol](#)
4. IVF: LVADs are preload dependent and IVF resuscitation is indicated for signs of hypotension and/or volume depletion
 - A. Adult: 500-1000 ml IV, IO as per patient condition
 - B. Pediatric: 10 – 20 ml/kg IV, IO as per patient condition
 - C. Repeat IVF bolus as indicated per patient condition
5. For persistent hypotension following IVF administration
 - A. Dopamine @ 10 – 20 mcg/kg/min IV
6. Dysrhythmias: Treat the patient NOT the monitor
 - A. Defibrillation/cardioversion only if patient compromised
 - i. Do NOT place pads directly over LVAD
 - B. Patient may be awake and alert despite ventricular arrhythmia (VF or VT)
 - C. Ventricular Tachycardia: treat with IV medication per protocol
 - D. Ventricular Fibrillation: treat the patient
 - i. Check to see if patient is breathing, if breathing NO CPR
 - ii. If patient is unresponsive, apneic, and failure of defibrillation attempt (as indicated) initiate CPR
7. Additional Care as per specific presumptive diagnosis, patient condition, cardiac disorder

Additional Considerations

- * Patients are anti-coagulated and prone to bleeding
- * GI bleeding being a common complication
- * Persistent bleeding following minor trauma may occur
- * An LVAD is an invasive device and is prone to infection
 - Source of infection to consider is the "Drive Line" (connects the internal device to the external controller)
 - DO NOT TOUCH the drive line but look for signs of infection at site
- * Bring all LVAD equipment during transport
- * Allow patient's family member who is educated on LVAD use and alarms to accompany patient during ambulance transport
- * Consult LVAD documentation regarding any alarms on controller device
- * HeartMate advisory alarms

Priority	System Controller Screen	Active Symbols	Alarm Means	To Resolve Alarm	
A D V I S O R Y	Connect Power ⊙ :04		One of the two power cables is disconnected	Promptly connect the disconnected power cable to power source (functioning Power Module or two fully-charged HeartMate 14 Volt Lithium-Ion batteries).	
	Replace Power ⊙ :02 + Low Battery ⊙ :06		Low Battery, Power input is low with less than 15 min. remaining	Promptly connect to a working or different power source (Power Module or two fully-charged HeartMate 14 Volt Lithium-Ion batteries).	
	Replace Controller Controller Fault + Call Hospital Contact Controller Fault		System Controller hardware fault	1. Switch to the backup System Controller. 2. Provide patient with a new System Controller.	
	Call Hospital Contact Backup Battery Fault		System Controller Backup Battery fault	Replace the 11 Volt Lithium-Ion backup battery. Note: If replacing the battery does not resolve the alarm, the System Controller may need replaced, or additional steps may be required. Call Thoratec with questions.	
	Low Speed ⊙ :03 + Call Hospital Contact ⊙ :07		Low Speed advisory warning	1. Use the System Monitor to check that the fixed speed and low speed limit have been appropriately set. 2. Replace the System Controller. 3. Clinically evaluate the patient.	
	Call Hospital Contact Driveline Fault		Driveline fault	1. Contact Thoratec to determine best next steps. 2. Use the System Monitor to silence the alarm while awaiting resolution, if needed. Note: The alarm must be active in order to access the alarm silence for this situation.	
			System Controller Backup Battery not installed	1. Install the 11 Volt Lithium-Ion backup battery in the System Controller. 2. Obtain a new backup battery replacement kit. Note: If replacing the battery does not resolve the alarm, the System Controller may need replaced, or additional steps may be required. Call Thoratec with questions.	
			Controller Clock not set	Use the System Monitor to set the System Controller's internal clock. Note: Be sure the System Monitor clock is correct.	
	Important! The pump running symbol is always lit green when the pump is running.				

* HeartMate hazard alarms

Priority	System Controller Screen	Active Symbols	Alarm Means	To Resolve Alarm
H A Z A R D	Low Flow ⊖ :03 + Call Hospital Contact ⊖ :07		Pump is off. The pump running symbol  is black.	<ol style="list-style-type: none"> 1. Check if the fixed speed setting is below 8,000 rpm AND the System Controller's backup battery is not installed. Under these conditions, the pump can only be started from the System Monitor's Clinical or Settings screen by pressing the Pump Start button. Otherwise, press any button on the System Controller to attempt pump start. 2. Switch to backup System Controller and attempt to restart pump. 3. Clinically evaluate patient.
	Connect Driveline ⊖ :02	 + 	Driveline is disconnected. The pump running symbol  is black.	<ol style="list-style-type: none"> 1. Immediately reconnect the driveline to System Controller and move the driveline safety tab on the System Controller to the locked position. 2. If alarm persists after reconnecting the driveline, press any button on the System Controller to attempt pump start. Otherwise, check if the fixed speed setting is below 8,000 rpm AND the System Controller's backup battery is not installed. Under these conditions, the pump can only be started from the System Monitor's Clinical or Settings screen by pressing the Pump Start button. 3. If driveline is connected and alarm persists, replace System Controller with pre-programmed backup System Controller.
	Backup Battery ⊖ :01 + Connect Power Immediately ⊖ :05	 +  + 	Both power cables are disconnected	Immediately connect to a working power source (Power Module or two fully-charged HeartMate 14 Volt Lithium-Ion batteries).
	Low Flow ⊖ :03 + Call Hospital Contact ⊖ :07		Low flow, flow is less than 2.5 lpm	<ol style="list-style-type: none"> 1. Ensure that the driveline is connected to System Controller. 2. Ensure that a power source is connected to System Controller. 3. Clinically evaluate patient.
	Replace Power Immediately ⊖ :02 + Low Battery ⊖ :06		Low Battery, Power input is extremely low with less than 5 min. remaining	Immediately connect to a working power source (Power Module or two fully-charged HeartMate 14 Volt Lithium-Ion batteries).

Important! The pump running  symbol is always lit green when the pump is running.

- * With pulsatile flow devices a systolic and diastolic blood pressure may be obtained
- * With continuous flow devices a mean arterial pressure (MAP) will be the only blood pressure obtained

Total Artificial Heart (AC-15)

Introduction

- * Serves as a bridge to heart transplantation for patients at risk of death from biventricular failure
- * Device features:
 - Both right and left ventricles + all heart valves removed (atria remain)
 - Same blood flow pathway as native heart
 - Patients WILL have a pulse
 - Patients WILL NOT have a cardiac rhythm
- * BP cuff should be utilized for monitoring
- * CPR is NOT effective and should not be performed
- * NO vasopressors should be utilized in the field
- * Patients are anticoagulated

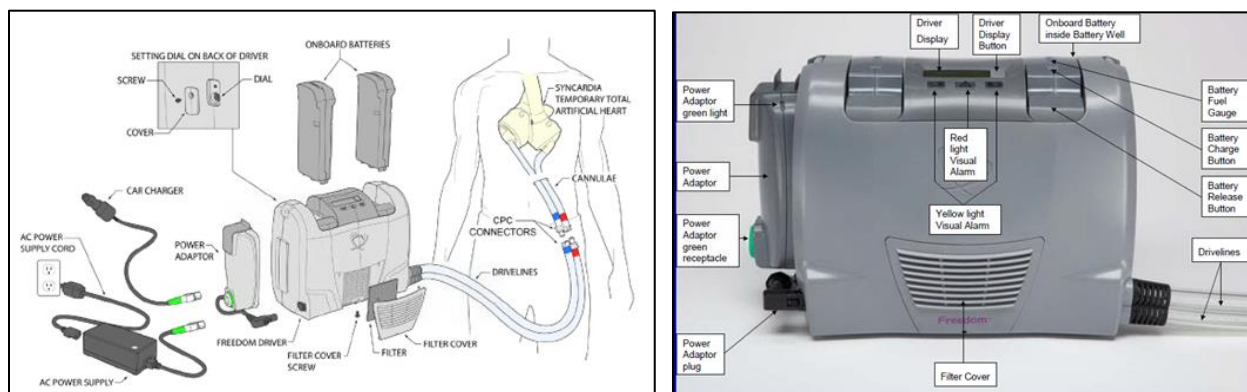

Troubleshooting

- * Alarms
 - Battery: beeping audible alarm and blinking yellow light
 - One or more batteries with < 30% charge or incorrectly installed
 - Replace battery(ies) **ONE AT A TIME** or connect to external power
 - Temperature: beeping audible alarm and blinking red light
 - Remove any debris blocker filter cover and/or fan
 - Move device to a cooler (or warmer) area
 - Fault: constant audible alarm and solid red light
 - If secondary to Valsalva/straining – have patient relax, interrupt Valsalva
 - If secondary to kinked drivelines – straighten drivelines
 - If disconnected from external power without battery – insert battery or connect to external power
 - If 1 or more batteries < 30% charge – replace battery
 - Driver malfunction – transport to hospital

Zoll LifeVest® Wearable Defibrillator (AC-16)

Introduction

- * LifeVest is a wearable cardioverter defibrillator for patients at risk for sudden cardiac arrest
- * The vest is worn under clothes directly against the patient's body
 - o ECG (4) electrodes continuously monitor the heart rhythm
 - o Therapy pads deliver treatment shocks when indicated
 - Therapy pads release a Blue™ gel prior to a treatment shock to improve shock conduction and mitigate burning
- * After LifeVest detects a treatable arrhythmia, the time to treatment will be between 25 and 60 seconds depending on the type and rate of the dysrhythmia and whether the patient presses the "response buttons"
 - o Depression of the response button will prevent a shock from being delivered
 - o Only the patient should ever press the response buttons
- * Emergency personnel can be shocked by the vest if it delivers a shock while personnel are in contact with the patient
 - o No one should touch the patient while a treatment shock is delivered
 - o LifeVest will warn bystanders with both a siren alert and a voice command stating "Bystanders, do not interfere" before a shock is delivered
- * Prior to delivering an external shock the monitor should be disconnected from the electrode belt
 - o The garment and belt do not need to be removed
- * If possible, the patient should bring the LifeVest, charger or charger and hotspot, and extra battery to the hospital

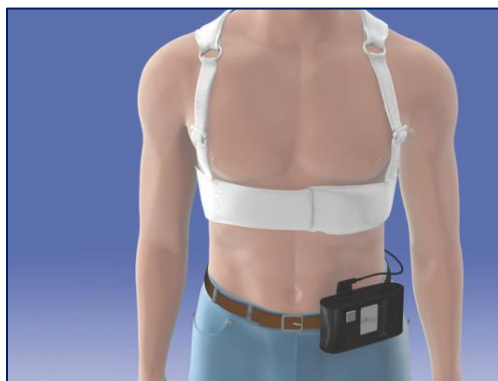

Garment

Monitor

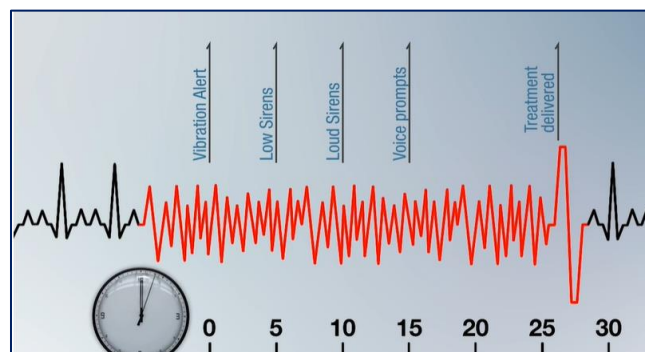
Response
button

LifeVest Alerts Sequence

- * Vibration alert
- * Single tone siren
- * Two tone siren
- * Voice prompt

<p>ALERT:</p> <ul style="list-style-type: none"> • Device Silent OR Gong Alert (SINGLE TONE) <p>VOICE:</p> <ul style="list-style-type: none"> • None — device silent • "Treatment has been given. Call your doctor." <p>STATUS:</p> <ul style="list-style-type: none"> • Device is monitoring the patient • Device may be alerting the patient to follow instructions on the screen 	<p>ALERT:</p> <ul style="list-style-type: none"> • Siren Alert (TWO TONE) <p>VOICE:</p> <ul style="list-style-type: none"> • "If patient is not responsive, call for help. Perform CPR." <p>STATUS:</p> <ul style="list-style-type: none"> • Device cannot detect ECG or the device has delivered the maximum number of treatments 	<p>ALERT:</p> <ul style="list-style-type: none"> • Siren Alert (TWO TONE) <p>VOICE:</p> <ul style="list-style-type: none"> • "Press response buttons to delay treatment." • "Bystanders, do not interfere." <p>STATUS:</p> <ul style="list-style-type: none"> • Device has detected a ventricular arrhythmia • Device is preparing to treat the patient • Shock likely • Stop CPR • Only the patient should press the response buttons (patient consciousness test) • Do not touch patient • Allow device to treat the patient
---	--	---

Management

1. Proceed with standard evaluation and treatment measures
2. CPR can be performed as long as the device is not broadcasting:
 - a. "Press response buttons to delay treatment"
 - b. "Bystanders, do not interfere"
3. When external defibrillation is available, remove the LifeVest wearable defibrillator and monitor/treat the patient with AED or MEDIC monitor/defibrillator
4. To remove the device
 - a. First pull out the battery
 - b. Remove the garment from the patient
5. When performing manual CPR ensure the battery has been removed from the LifeVest to prevent shock delivery during CPR



To disable the LifeVest
– remove the battery

Heat Exposure – Hyperthermia (TE-4)

Introduction

- * Heat illnesses encompass a spectrum of disorders from simple muscle cramps and heat exhaustion to life-threatening heat stroke
- * Temperatures more than 107°F do not occur from infectious sources and require aggressive treatment to cool the patient
- * Differential Diagnosis
 - CNS lesion
 - Dehydration
 - Delirium tremens
 - Environmental exposure
 - Fever
 - Hyperthyroidism
 - Medication intoxication
- * Risk Factors
 - Drugs
 - Amphetamines
 - Anticholinergics
 - Aspirin
 - Cocaine
 - Neuroleptics
 - Endocrine disorders
 - Exertion
 - Heat exposure
 - Hyperthyroidism
 - Status epilepticus
- * Clinical Presentation
 - Heat cramps
 - Benign muscle cramping
 - Body temperature normal, typically no dehydration
 - Warm, moist skin
 - Secondary to hyponatremia
 - Heat exhaustion
 - Dehydration
 - Headache
 - Malaise, irritability
 - Nausea, vomiting
 - Profuse sweating
 - Tachycardia
 - Heat stroke
 - Altered mental status (confusion to coma)
 - Elevated temperature
 - Often dry skin
 - Tachycardia, tachypnea

Basic Medical Care

1. Confirm scene safety
2. Ensure a cool protective environment for yourself and the patient & initiate cooling
3. [Medical Initial Assessment Protocol](#) or [Pediatric Initial Assessment Protocol](#)
4. Maintain airway; suction as needed
5. Assess vital signs including temperature
6. Provide supplemental oxygen per patient condition to maintain SpO₂ = 94 – 97%
7. Provide assisted ventilations with bag-valve mask and 100% oxygen if breathing or ventilatory compromise is apparent
8. As available, an ice water immersion tank should be utilized for patients with heat exhaustion or heat stroke to cool to < 102° F prior to transport
 - A. Must maintain protection of patient from head dropping beneath water surface
9. Immediately initiate cooling central body regions with ice packs
 - A. Axilla, groin, scalp, chest, abdomen
10. Assess blood glucose
 - A. Oral glucose for hypoglycemia and patient alert with intact gag reflex
11. Expose patient and mist skin wet with room temperature saline
 - A. Apply fan / cool air blow-by (hold if patient begins to shiver)

Advanced Medical Care

1. Obtain 4-lead, 12-lead ECG as indicated and refer to appropriate protocol as indicated
2. IVF as indicated per patient condition
 - A. Adults:
 - i. Hemodynamically unstable: IVF wide open
 - ii. Hemodynamically stable: TKO
 - B. Pediatrics
 - i. Hemodynamically unstable: 10 – 20 ml/kg bolus and reassess
 - ii. Hemodynamically stable: TKO
3. Ondansetron (Zofran®) for nausea/vomiting
 - A. Adult: 4 – 8 mg IV, PO
 - B. Pediatric dose = 0.15 mg/kg IV, PO (maximum 4 mg)
4. Fentanyl for pain control
 - A. Adults:
 - i. 1 – 2 mcg/kg IN (maximum 200 mcg)
 - ii. 0.5 – 1 mcg/kg IV, IM (maximum 100 mcg)
 - iii. May repeat x1 in 15 minutes as indicated (maximum 100 mcg any route)
 - B. Pediatrics:
 - i. 0.5 – 1 mcg/kg IV, IM, IN (maximum 100 mcg)
5. Alternative analgesic: nitrous oxide via patient-controlled inhalation
6. Advanced Airway management as indicated
 - A. [Airway: Intubation Protocol](#)
 - B. [Airway: BIAD Protocol](#)
7. Ensure proper tube placement using capnometry, SpO₂ and ventilate with 100% oxygen
8. Additional care as per appropriate protocol

Cold Exposure – Hypothermia (TE-5)

Introduction

- * Definitions
 - Body core temperature < 95°F (35°C)
 - Primary hypothermia = due to cold environment exposure
 - Secondary hypothermia = illness that impairs thermoregulation
 - Mild hypothermia: temperature 90°-95°F (32°-35°C)
 - Moderate hypothermia: temperature 82°-90°F (28°-32°C)
 - Severe hypothermia: temperature < 82°F (28°C)
- * Differential Diagnosis
 - CNS dysfunction
 - Environment exposure
 - Hypoglycemia
 - Hypothyroidism
 - Hypoadrenalism
 - Sepsis
- * Clinical Presentation
 - Cold exposure
 - Shivering (may be absent in severe hypothermia)
 - Altered consciousness
 - Dehydration
 - Tachypnea then bradypnea
 - Bradycardia to cardiac arrest
- * Risk Factors
 - Exhaustion
 - Age extremes
 - Very young age
 - Alcohol and drug use
 - Mental health illnesses
 - Medications
 - Antidepressants
 - Antipsychotics
 - Opioids
 - Sedatives

Basic Medical Care

1. Confirm scene safety
2. Ensure a protective environment for yourself and the patient
3. [Medical Initial Assessment Protocol](#) or [Pediatric Initial Assessment Protocol](#)
4. Maintain airway; suction as needed
5. Assess vital signs including temperature
6. Provide supplemental oxygen per patient condition to maintain SpO₂ = 94 – 97%
7. Provide assisted ventilations with bag-valve mask and 100% oxygen if breathing or ventilatory compromise is apparent
8. Assess blood glucose
 - A. Oral glucose for hypoglycemia and patient alert with intact gag reflex
9. Remove all wet clothing
10. Initiate re-warming
 - A. Passive external: Provide warm environment, insulate from further heat loss
 - B. Active external: Heater, warm blankets
11. Assess for associated trauma
12. Remove rings, bracelets, or constricting items on any extremity with potential frostbite

Advanced Medical Care

1. Obtain 4-lead ECG and refer to appropriate protocol as indicated
2. 12-lead ECG as indicated
3. IVF as indicated per patient condition
 - A. Adults:
 - i. Hemodynamically unstable: IVF wide open
 - ii. Hemodynamically stable: TKO
 - B. Pediatrics
 - i. Hemodynamically unstable: 10 – 20 ml/kg bolus and reassess
 - ii. Hemodynamically stable: TKO
1. For hypoglycemia treat per [Diabetic Problems Hypoglycemia Protocol](#)
4. For suspected narcotic use naloxone (Narcan®)
 - A. Adults: 1 – 2 mg IV, IO, IN
 - B. Pediatrics: 0.01 – 0.1 mg/kg IV, IO, IN
5. Advanced Airway management as indicated
 - A. [Airway: Intubation Protocol](#)
 - B. [Airway: BIAD Protocol](#)
6. Ensure proper tube placement using capnometry, SpO₂ and ventilate with 100% oxygen
7. Assess for associated trauma
8. Additional care as per appropriate protocol

9. For suspected frostbite
 - A. Do not rub affected part
 - B. Do not break or open blisters
 - C. Apply sterile dressing
 - D. Do not attempt to thaw frozen area unless ensured area will not refreeze prior to arrival to definitive care
 - E. Fentanyl for pain control
 - i. Adults:
 - 1 – 2 mcg/kg IN (maximum 200 mcg)
 - 0.5 – 1 mcg/kg IV, IM (maximum 100 mcg)
 - May repeat x1 in 15 minutes as indicated (max 100 mcg any route)
 - ii. Pediatrics:
 - 0.5 – 1 mcg/kg IV, IM, IN (maximum 100 mcg)
 - Contact Medical Control for repeat dosing
10. For patient in cardiac arrest
 - A. Continue CPR until core temperature > 90°F
 - B. Defibrillation typically unsuccessful at temperature < 90°F
 - C. Hold ACLS medications until core temperature > 86°F
 - D. Consider withholding CPR if patient has organized rhythm or has other signs of life
 - i. Contact medical control
 - E. Consider: no patient is dead until warm and dead (temp \geq 93.2°F; 32°C)

Additional Considerations – Heat Exposure

- * Initiate cooling activities immediately
 - An ice water immersion tank should be utilized for patients with heat exhaustion or heat stroke to cool to < 102° F prior to transport
 - Must maintain protection of patient from head dropping beneath water surface
- * Extremes of age are more prone to heat related emergencies
- * Assess for predisposing factors
 - Cocaine, amphetamines, salicylates, tricyclic antidepressants, phenothiazines, anticholinergic medications
- * A thermometer should be used for patients where clinical signs and symptoms of hyperthermia are not apparent, and a body temperature reading would alter clinical decision-making in the prehospital environment
- * There is no role for antipyretics such as acetaminophen or ibuprofen in patients with non-infectious causes of hyperthermia
- * Heat cramps = benign muscle cramping due to dehydration & typically not associated with elevated temperature
- * Heat exhaustion = dehydration, salt depletion, dizziness, fever, cramping, N/V
- * Heat stroke = altered mental status, dehydration, elevated temperature

Additional Considerations – Cold Exposure

- * Extremes of age are more susceptible to cold emergencies
- * Osborn (J) waves = ECG: slow positive deflection at the end of QRS complex, occur at temperature < 90°F (32°C)
- * Dysrhythmias classically progress:
 - NSR → SB → AFIB with slow ventricular response → VFIB → asystole
- * Obtain as much information from bystanders as possible
 - Duration of exposure, any immersion
 - Drug or alcohol history
- * Hypothermic patients should be handled with caution
 - Dysrhythmias, primarily ventricular fibrillation, are commonplace at core temperatures < 86°F, and may be precipitated with careless handling of the patient
- * A thermometer should be used for patients where clinical signs and symptoms of hypothermia are not apparent, and a body temperature reading would alter clinical decision-making in the prehospital environment
- * In cardiac arrest the primary treatment is active core rewarming
 - The hypothermic heart is usually unresponsive to most cardiac medications, defibrillation, and pacing
 - If the patient is below 86°F or 30°C only defibrillate once if defibrillation is required
 - Normal defibrillation procedure may resume once patient reaches 86°F (30°C)
 - Below 86°F (30°C) anti-dysrhythmics may not work and, if given, should be given at reduced intervals contact medical control before they are administered
 - Below 86°F (30°C) or pacing should not be performed

Hemorrhage – Medical Etiology (UP-7/UP-9)

Etiologies

- * Dental hemorrhage
- * Dialysis access hemorrhage
- * Epistaxis
- * Hematemesis
- * Hematochezia / melena
- * Hematuria
- * Hemoptysis
- * Intracranial hemorrhage

Differential Diagnosis

- * Medical Shock
 - Anaphylaxis
 - Cardiogenic
 - Drug induced
 - Hypovolemic
 - Neurogenic
 - Sepsis
- * Traumatic Shock
 - External hemorrhage
 - Internal hemorrhage
 - Cardiac tamponade
 - Neurogenic

Basic Medical Care

1. Confirm scene safety
2. [Medical Initial Assessment Protocol](#) or [Pediatric Initial Assessment Protocol](#)
3. Maintain airway; suction as needed
4. Assess vital signs
5. Provide supplemental oxygen per patient condition to maintain SpO₂ = 94 – 97%
6. Provide assisted ventilations with bag-valve mask and 100% oxygen if breathing or ventilatory compromise is apparent
7. Additional care as per etiology of hemorrhage

Dental Hemorrhage (UP-7)

1. Have patient bite down on gauze packing
2. Assess for trauma and treat as per appropriate protocol
3. For avulsed tooth
 - A. Gently irrigate and attempt to replace into socket
 - i. Do NOT rub or scrub tooth
 - B. If unable to replace into socket have patient hold tooth in their cheek
 - i. Patient must have normal mental status
 - ii. Otherwise place tooth in milk or normal saline

Dialysis Access Hemorrhage

1. Apply direct pressure to site
2. Apply MEDIC tourniquet for presumed life-threatening hemorrhage not controlled with direct pressure
 - A. Be sure to apply proximal to the shunt (**NOT** directly on the shunt)

Epistaxis (UP-9)

1. Have patient forcibly blow nose
 - A. Immediately apply direct pressure by pinching nostrils & tilting head forward
2. Suction as necessary
3. Assess for trauma and treat as per appropriate protocol
4. IVF bolus as indicated per patient condition
 - A. Adult: 500 – 1000 ml
 - B. Pediatric: 10 – 20 ml/kg

Gastrointestinal Hemorrhage

1. Maintain patient in position to maximum airway protection and patient comfort
2. Provide suctioning as indicated
3. IVF bolus for signs of hypotension/dehydration
 - A. Adult: 500 – 1000 ml as per patient condition
 - B. Pediatric: 10 – 20 ml/kg
4. Reassess vital signs following IVF bolus
5. Ondansetron (Zofran®) for nausea/vomiting
 - A. Adult: 4 – 8 mg PO, IV, IM
 - B. Pediatric dose = 0.15 mg/kg PO, IV, IM (maximum 4 mg)

Advanced Medical Care

1. Obtain 4-lead ECG and refer to appropriate protocol as indicated
2. IVF as indicated per patient condition
 - A. Adults:
 - i. Hemodynamically unstable: IVF wide open
 - ii. Hemodynamically stable: TKO
 - B. Pediatrics
 - i. Hemodynamically unstable: 10 – 20 ml/kg bolus and reassess
 - ii. Hemodynamically stable: TKO
3. For persistent hypotension following IVF resuscitation
 - A. Dopamine @ 10 – 20 mcg/kg/min IV
4. Ondansetron (Zofran®) for nausea or vomiting
 - A. Adults: 4 – 8 mg IV, PO
 - B. Pediatrics: 0.15 mg/kg IV, PO (maximum 4 mg)
5. Fentanyl for pain control
 - A. Adults:
 - i. 1 – 2 mcg/kg IN (maximum 200 mcg)
 - ii. 0.5 – 1 mcg/kg IV, IM (maximum 100 mcg)
 - iii. May repeat x1 in 15 minutes as indicated (maximum 100 mcg any route)
 - B. Pediatrics:
 - i. 0.5 – 1 mcg/kg IV, IM, IN (maximum 100 mcg)
 - ii. Contact Medical Control for repeat dosing
6. Advanced Airway management as indicated
 - A. [Airway: Intubation Protocol](#)
 - B. [Airway: BIAD Protocol](#)
7. Ensure proper tube placement using capnometry, SpO₂ and ventilate with 100% oxygen

Additional Considerations

- * Hypertension typically does not cause epistaxis; however, it may worsen the condition
 - Contact Medical Control for labetalol for patient that is significantly hypertensive
- * Primary avulsed teeth (< 5 years of age) are not replaced
- * Secondary (permanent) avulsed teeth may be replanted after irrigating with tap water or saline
 - Irrigation should be done gently without debriding or scrubbing the tooth

Industrial Accident

Basic Medical Care

1. Confirm scene safety
2. [Trauma Initial Assessment Protocol](#) or [Pediatric Trauma Assessment Protocol](#)
3. Maintain airway; suction as needed
4. Assess vital signs
5. Provide supplemental oxygen per patient condition to maintain $SpO_2 = 94 - 97\%$
 - A. Provide assisted ventilations with bag-valve mask and 100% oxygen if breathing or ventilatory compromise is apparent
6. Control any active external bleeding with direct pressure
 - A. Apply MEDIC tourniquet for presumed life-threatening extremity hemorrhage not controlled with direct pressure
7. Splint any long bone deformity or area where crush injury has occurred
 - A. Dislocated joints should be splinted in position of deformity
 - B. Fractures should be realigned and splinted from joint above through joint below
 - C. Distal pulses should be assessed before and after realignment and splinting
8. Ensure spinal motion restriction as indicated by mechanism of injury and presentation
9. Attempt to locate any amputated appendage or part
 - A. Gently irrigate with normal saline and wrap in normal saline moistened gauze
 - B. Place in plastic bag and put bag on ice (as available) and transport with patient
 - C. Amputated parts should never be in direct contact with ice

Advanced Medical Care

1. Obtain 4-lead and refer to appropriate protocol as indicated
2. IVF as indicated per patient condition
 - A. Adults:
 - i. Hemodynamically unstable: IVF wide open
 - ii. Hemodynamically stable: TKO
 - B. Pediatrics
 - i. Hemodynamically unstable: 10 – 20 ml/kg bolus and reassess
 - ii. Hemodynamically stable: TKO
3. Fentanyl for pain control
 - A. Adults:
 - i. 1 – 2 mcg/kg IN (maximum 200 mcg)
 - ii. 0.5 – 1 mcg/kg IV, IM (maximum 100 mcg)
 - B. Pediatrics:
 - i. 0.5 – 1 mcg/kg IV, IM, IN (maximum 100 mcg)
4. Alternative analgesic: nitrous oxide via patient-controlled inhalation
5. Advanced Airway management as indicated
 - A. [Airway: Intubation Protocol](#)
 - B. [Airway: BIAD Protocol](#)
6. Ensure proper tube placement using capnometry, SpO_2 and ventilate with 100% oxygen

Overdose / Toxic Ingestion (TE-7)

Differential Diagnosis

- * Acetaminophen
- * Alcohols
- * Anticholinergics
- * Cardiac medications
- * Caustics
- * Illicit drugs
- * Opioids
- * Organophosphates
- * Solvents
- * Stimulants
- * Tricyclic Antidepressants
- * Other medications

Clinical Presentations

- * Ingestions
 - Abdominal pain
 - Altered mental status
 - Miosis / mydriasis
 - Nausea, vomiting, diarrhea
 - Oral burns
 - Respiratory depression
 - Salivation
 - Seizures
- * Inhalation
 - Cyanosis
 - Dizziness
 - Headache
 - Lethargy
 - Nausea / vomiting
- * Injection
 - Edema
 - Euphoria / drowsiness
 - Hypotension
 - Nausea / vomiting
 - Puncture

Basic Medical Care

1. Confirm scene safety
2. [Medical Initial Assessment Protocol](#) or [Pediatric Initial Assessment Protocol](#)
3. Maintain airway; suction as needed
4. Assess vital signs
5. Provide supplemental oxygen per patient condition to maintain SpO₂ = 94 – 97%
6. Provide assisted ventilations with bag-valve mask and 100% oxygen if breathing or ventilatory compromise is apparent
7. Assess blood glucose level
 - A. Oral glucose for hypoglycemia and patient alert with intact gag reflex
8. Naloxone (Narcan®) for presumed narcotic – opioid overdose
 - A. Adult: 1 – 2 mg IN
 - B. Pediatric: 0.01 – 0.1 mg/kg IN
 - C. May repeat as indicated to maximum of 10 mg
9. Determine nature of ingestion
 - A. Bring any pill bottles found to the emergency department with the patient
10. For evidence of contamination, immediately decontaminate
 - A. Ensure personal protection during decontamination
 - B. Remove patient from source
 - C. Remove clothing
 - D. Wash skin and hair
 - E. Flush eyes and mucous membranes
11. Additional care as per substance ingestion/exposure

Advanced Medical Care

1. Apply monitor and obtain 4-lead and refer to appropriate protocol as indicated
2. 12-lead ECG as indicated per patient's ingestion/exposure
3. For presumed opioid overdose administer naloxone (Narcan®)
 - A. Adults: 1 – 2 mg IN, IV
 - B. Pediatrics: 0.01 – 0.1 mg/kg IN, IV
4. IVF as indicated per patient condition
 - A. Adults:
 - i. Hemodynamically unstable: IVF wide open
 - ii. Hemodynamically stable: TKO
 - B. Pediatrics
 - i. Hemodynamically unstable: 10 – 20 ml/kg bolus and reassess
 - ii. Hemodynamically stable: TKO
5. For hypoglycemia treatment as per [Diabetic Problems Hypoglycemia Protocol](#)
6. Advanced Airway management as indicated
 - A. [Airway: Intubation Protocol](#)
 - B. [Airway: BIAD Protocol](#)
7. Ensure proper tube placement using capnometry, SpO₂ and ventilate with 100% oxygen
8. Additional care as per substance ingestion/exposure

Additional Considerations

- * Consider contacting North Carolina State Poison Control Center
 - **800-222-1222**
- * Do NOT induce vomiting
 - Ipecac is not to be utilized unless directed by Poison Center or Medical Control
- * Secure remaining medications away from patient
- * For incidents involving industrial or chemical spills, radiation accidents, or other incidents where hazardous materials are involved, strict communication with the fire department/hazardous materials team should be established
- * Sedation for patients noted to be extremely agitated should be emergently considered because rapid decompensation is possible
- * Intentional overdoses often involve multiple agents taken simultaneously and providers must keep a degree of suspicion for poly-pharmacy overdose and treat accordingly
- * Consider restraints as per Patient Restraints Protocol
- * Effort should be made to obtain any possible medications on scene of intentional ingestions
- * Airway management and ventilatory assistance remains paramount and must be performed while preparing naloxone for administration
- * Naloxone administration may precipitate narcotic withdrawal in patients who chronically abuse narcotics
 - Providers must be prepared to manage acute agitation and/or nausea/vomiting that may result from narcotic withdrawal following naloxone administration
- * Many overdoses may involve multiple agents and therefore naloxone administration may not fully restore adequate respiratory effort
 - Provider must be prepared to continue to manage the airway and assist ventilations as indicated
- * Signs/symptoms (toxidromes):
 - **Anticholinergics:** AMS, dilated pupils, hyperthermia, dry skin
 - **Aspirin:** tachypnea, altered mental status
 - **Cardiac medications:** dysrhythmias, bradycardia/tachycardia, hypotension
 - **Cyanide:** altered mental status, hypotension, severe acidemia
 - **Depressants:** hypotension, respiratory depression
 - **Opioids:** respiratory depression, miosis, altered mental status
 - **Organophosphates:** salivation, lacrimation, urination, defecation, GI distress, emesis (SLUDGE)
 - **Stimulants:** tachycardia, tachypnea, hypertension, hyperthermia, AMS
 - **TCA's:** dysrhythmia, hypotension, altered mental status, seizure

Poison Specific Therapies

1. Opioids (narcotics)
 - A. Naloxone (Narcan®)
 - i. Adults: 1 – 2 mg IV, IN, IM
 - IM administration should be used only as the last option
 - ii. Pediatrics: 0.01 – 0.1 mg/kg IV, IN, IM (maximum 2 mg)
 - IM administration should be used only as the last option
 - B. May repeat every 5 minutes to maximum of 10 mg
2. Tricyclic antidepressants
 - A. Sodium bicarbonate
 - i. Adults: 50 – 100 mEq (50 – 100 ml) IV, IO
 - ii. Pediatrics: 1 mEq/kg (1 ml/kg) maximum 50 mEq (50 ml) IV, IO
 - B. Give based on presence of tachycardia, hypotension with QRS widening
3. Stimulants/sympathomimetics (cocaine associated agitation)
 - A. Midazolam (Versed®)
 - i. Adults: 2.5 – 5 mg IV, IM or 10 mg IN
 - ii. Pediatrics: 0.15 mg/kg IV, IM (max 5 mg) or 0.2 mg/kg IN (max 10 mg)
 - B. May repeat in 10 – 15 minutes for continued or worsening symptoms
4. Organophosphates
 - A. Duo-dote kit (atropine/Pralidoxime) IM
 - B. Atropine
 - i. Adult: 2 mg IV, IM
 - ii. Pediatric: 0.02 mg/kg IV (minimum 0.1 mg; maximum 1 mg)
 - C. May repeat every 5 minutes until drying of secretions occurs
5. Calcium Channel Blockers / Beta Blockers
 - A. Calcium gluconate (10% solution) over 2 min
 - i. Adults: 2 grams (20 ml) IV
 - ii. Pediatrics: 20 mg/kg IO, IV (0.2 ml/kg); maximum 2 grams (20 ml) IV
 - B. Glucagon
 - i. Adults: 2 mg IV
 - ii. Pediatrics: 0.05 mg/kg IV (maximum 2 mg)
 - C. Dopamine @ 10 – 20 mcg/kg/min IV
6. Cyanide
 - A. Sodium thiosulfate 12.5 grams IV over 10 minutes
 - B. Pediatrics: 250 mg/kg IV (maximum 12.5 grams) over 10 minutes

Additional Considerations

- * Naloxone IM is to be reserved as a last option as its absorption and its anti-opioid effects are inconsistent when given IM and therefore creates difficulty in ascertaining which effect will clear first (opioid vs. naloxone) which then leads to difficulty in determining appropriateness for release

Pregnancy & Childbirth

Pertinent Obstetric History

- * Gravida / parity number
- * Last menstrual period
- * Estimated gestation age
- * Due date
- * Contractions
 - Onset
 - Frequency
 - Duration
- * Gestational complications – prior, current
- * Fetal movement

Differential Diagnosis

- * Vaginal bleeding
 - Labor
 - Placenta previa
 - Placental abruption
 - Trauma
- * Abdominal pain
 - Labor
 - Trauma
 - Differential as per [Abdominal Pain Protocol](#)
- * Hypertension
 - Pregnancy induced hypertension
 - Pre-eclampsia/Eclampsia

Basic Medical Care

1. [Medical Initial Assessment Protocol](#)
2. Maintain airway; suction as needed
3. Assess vital signs
4. Provide supplemental oxygen per patient condition to maintain SpO₂ = 94 – 97%
5. Provide assisted ventilations with bag-valve mask and 100% oxygen if breathing or ventilatory compromise is apparent
6. Maintaining appropriate privacy, remove clothes below waist to visualize delivery progression or any bleeding present as indicated by patient presentation
7. Additional care per appropriate protocol
8. For hypotension, place in the left lateral decubitus position

Advanced Medical Care

1. Obtain rhythm strip and refer to appropriate protocol as indicated
2. IVF as indicated per patient presentation
 - A. Hemodynamically unstable: IVF wide open
 - B. Hemodynamically stable: TKO
3. For hypotension, transport in left lateral decubitus position
4. Advanced Airway management as indicated
 - A. [Airway: Intubation Protocol](#)
 - B. [Airway: BIAD Protocol](#)
5. Ensure proper tube placement using capnometry, SpO₂ and ventilate with 100% oxygen
6. Ondansetron (Zofran®) 4 – 8 mg IV, PO for nausea and/or vomiting
7. Additional care per appropriate protocol
7. Fentanyl for pain control as patient condition permits
 - A. 0.5 – 1 mcg/kg IV, IM (maximum 100 mcg)
 - B. 1 – 2 mcg/kg IN (maximum 200 mcg)
 - C. May repeat x1 in 15 minutes as indicated (maximum 100 mcg any route)

Additional Considerations

- * Decision to transport versus remain and deliver is multifactorial and difficult
 - Generally, it is preferable to transport
 - Factors that will impact decision include:
 - Number of previous deliveries
 - Length of previous labors
 - Frequency of contractions
 - Urge to push
 - Presence of crowning

CHILDBIRTH (AO-1)

Basic Medical Care – No Crowning

1. Observe and reassess

Basic Medical Care – Crowning

1. Gently control the progress of the head
2. Support the head with one hand as it is delivered
3. Clear the infant's airway by suctioning with bulb syringe
 - A. Suction mouth then nose
4. Check to ensure that the umbilical cord is not wrapped around the head / neck (nuchal)
 - A. Gently slip the cord over the head
 - i. If unable to easily slip over the head, it may be possible to slip it back over the shoulders and deliver the body through the loop
 - B. If necessary – unable to slip cord over the head; double-clamp and cut the cord between clamps (must ensure cord is not potentially cord of a twin gestation)
5. Help direct the anterior shoulder under the symphysis pubis with downward pressure on the side of the neonate's head
6. Apply gentle upward pressure to deliver the posterior shoulder
7. Support the infant through the remainder of the delivery
8. Clamp the cord approximately two (2) inches from the infant's abdomen and cut
9. Stimulate the infant and clear the airway
10. Dry and wrap the infant for warmth
11. Assess infants APGAR score at one and five minutes:
12. Deliver the placenta (never pull on umbilical cord to deliver the placenta)
13. Massage the fundus of the uterus
14. Monitor for post-partum hemorrhage

Childbirth Complications

1. For prolapsed cord
 - A. Encourage mother to refrain from pushing
 - B. Place in Trendelenburg position
 - C. Insert fingers into vagina to relieve cord pressure by displacing fetal head up
 - D. Keep cord moist with saline soaked gauze
2. For breech presentation
 - A. Encourage mother to refrain from pushing
 - B. Place in Trendelenburg position
 - C. Support presenting part(s); do NOT pull
3. For Shoulder Dystocia
 - A. Hyperflex the mother's hips and thighs towards her chest and apply anterior to posterior pressure with lateral to medial pressure supra-pubic in attempt to rotate the baby's shoulders off the pelvic rim

NEWLY BORN (AO-2)

Basic Medical Care

1. [Pediatric Initial Assessment Protocol](#)
2. Assess estimated gestational age
3. Suction oropharynx as required for meconium present
 - A. May require positive pressure ventilation with BVM based on patient's condition
4. Dry infant and keep warm
5. Position & clear airway as indicated
6. Assess APGAR score
 - A. Heart rate > 100 BPM
 - i. For color normal = monitor and reassess
 - ii. For color cyanotic = provide supplemental oxygen
 - B. Heart rate 60 – 100
 - i. Provide positive pressure ventilation
 - ii. [Airway: Pediatric Protocol](#)
 - iii. Reassess HR after 30 seconds of BVM ventilation
 - C. Heart rate < 60 BPM
 - i. Initiate CPR (compressions @ 100 – 120 min)
 - ii. Provide positive pressure ventilation
 - iii. Compression to ventilation ratio = 3:1
 - iv. [Airway: Pediatric Protocol](#)
 - D. Respirations
 - i. Present = monitor and reassess
 - ii. Respirations absent = stimulate, suction
 - iii. Respirations remain absent = initiate BVM ventilations (ventilations @ 40/min)
 - E. Color
 - i. Pink – monitor and reassess
 - ii. Cyanotic – provide supplemental oxygen
 - iii. [Airway: Pediatric Protocol](#)
7. Consider maternal hypoglycemia & maternal medication effects
8. Reassess [APGAR score](#)

Advanced Medical Care

1. Heart rate < 60 BPM
 - A. Epinephrine (1:10,000) 0.01 mg/kg; (0.1 ml/kg) IO, IV (maximum 1 mg; 1 ml)
2. Consider hypoglycemia
 - A. D10 @ 2 ml/kg as indicated
 - i. Repeat based on clinical condition and blood glucose level
3. IVF bolus: 10 ml/kg IV, IO for continued lethargy
4. Consider maternal medication effects
 - A. Naloxone (Narcan®) 0.01 – 0.1 mg/kg IN, IV as indicated

APGAR Score

Sign	0	1	2
Heart Rate	Absent	< 100 BPM	> 100 BPM
Respirations	Absent	Slow, irregular	Good, crying
Muscle Tone	Limp	Some flexion	Active motion
Reflexes	None	Grimace	Cough, sneeze, cry
Color	Blue	Pink, blue extremities	Pink

Physiologic Changes of Pregnancy

Parameter	Non-pregnant	Change	Pregnant
Cardiovascular			
Heart Rate	70-80 BPM	Increases	80-95 BPM
Cardiac Output	4.5 L/min	Increases	6 L/min
Blood Pressure	110/70	Decreases	100/55
Hematological			
Blood volume	4000 ml	Increases	5500 – 6000 ml
Plasma volume	2400 ml	Increases	3700 ml
Hemoglobin	12-14 gram/dL	Decreases	10-12 gram/dL
Respiratory			
Tidal volume	500 - 700 ml	Increases	700 - 900 ml
Respiratory rate	12 – 16 BPM	Increases	18-24 BPM
Residual volume	1200 ml	Increases	1800 ml
pO ₂	95 – 100 mmHg	Increases	100 – 108 mmHg
pCO ₂	40 mmHg	Decreases	30 mmHg

Obstetrical Emergencies (A0-3)

Preeclampsia / Eclampsia

Clinical Presentation

- * Edema (severe; especially if involves face or hands)
- * Headache
- * Hyper-reflexia
- * Hypertension > 160/110
- * Proteinuria
- * Visual changes
- * Typically occurs between 20-weeks gestation and 6-weeks post partum

Risk Factors

- * History of preeclampsia
- * Gestational diabetes
- * History of hypertension
- * Maternal age < 20-years or > 35-years of age
- * Molar pregnancy
- * Multiple gestation
- * Obesity
- * Primagravida

Basic Medical Care

1. [Medical Initial Assessment Protocol](#)
2. Maintain airway; suction as needed
3. Assess vital signs
4. Provide supplemental oxygen per patient condition to maintain SpO₂ = 94 – 97%
5. Provide assisted ventilations with bag-valve mask and 100% oxygen if breathing or ventilatory compromise is apparent
6. For hypertension, position patient in left lateral decubitus position (left side down)
7. Seizure precautions

Advanced Medical Care

1. Labetalol (Normodyne®) 20 mg IV for preeclampsia
 - A. Repeat labetalol 20 mg IV for persistent symptoms or hypertension
2. Transport patient in the left lateral decubitus position (left side down)
3. Magnesium sulfate 4 grams IV over 10 minutes (4 grams in 150 ml NS) for eclampsia
 - A. Monitor for signs for magnesium toxicity:
 - i. Hyporeflexia, respiratory depression, hypotension
 - ii. Stop infusion if present
4. Midazolam (Versed®) 10 mg IM, IN for persistent seizure activity

Placental Abruption

Introduction

- * Partial or complete detachment of the placenta from its normal implantation site
- * Occurs in 1 in 200 deliveries
- * Accounts for 30% of cases of antepartum hemorrhage
- * Risk factors = trauma, hypertension, acute decompression of distended uterus

Clinical Presentation

- * Painful dark vaginal bleeding (classic presentation)
- * Uterine irritability
- * Uterine tenderness

Basic Medical Care

1. [Medical Initial Assessment Protocol](#)
2. Maintain airway; suction as needed
3. Assess vital signs
4. Provide supplemental oxygen per patient condition to maintain $SpO_2 = 94 - 97\%$
5. Provide assisted ventilations with bag-valve mask and 100% oxygen if breathing or ventilatory compromise is apparent
6. Do not attempt to localize the of vaginal bleeding beyond visual inspection of perineum

Advanced Medical Care

1. IVF resuscitation as indicated
 - A. Hemodynamically unstable: IVF wide open
 - B. Hemodynamically stable: TKO
2. Fentanyl for pain control
 - A. 1 – 2 mcg/kg IN (maximum 200 mcg)
 - B. 0.5 – 1 mcg/kg IV, IM (maximum 100 mcg)
 - C. May repeat x1 in 15 minutes as indicated (maximum 100 mcg any route)
3. Ensure necessary equipment for emergent delivery is immediately available

Placenta Previa

Introduction

- * Implantation of the placenta in the lower uterine segment in advance of the fetal presenting part after 24 weeks gestation
- * Occurs in 1 in 250 deliveries
- * Accounts for 20% of cases of antepartum hemorrhage

Clinical Presentation

- * Painless bright red vaginal bleeding (classic presentation)
- * Contraction may or may not be present
- * Potential for hypotension

Basic Medical Care

1. [Medical Initial Assessment Protocol](#)
2. Maintain airway; suction as needed
3. Assess vital signs
4. Provide supplemental oxygen per patient condition to maintain $SpO_2 = 94 - 97\%$
5. Provide assisted ventilations with bag-valve mask and 100% oxygen if breathing or ventilatory compromise is apparent
6. Do not attempt to localize the of vaginal bleeding beyond visual inspection of perineum

Advanced Medical Care

1. IVF resuscitation as indicated
 - A. Hemodynamically unstable: IVF wide open
 - B. Hemodynamically stable: TKO
2. Ensure necessary equipment for emergent delivery is immediately available

Additional Considerations – Breech Presentation

- * Allow the buttocks and trunk to deliver spontaneously
- * As the baby is delivered, continue to support with both hands
- * Attempt to deliver the anterior shoulder and arm and then deliver the posterior shoulder and arm
- * The arms need to be delivered to enable the head to be delivered
- * Assist with the delivery of the head by exerting pressure above the pubic symphysis
- * The face should be kept in a downward position
- * Do not allow hyperextension of the neck as the head is delivered

Additional Considerations – Newborn Resuscitation

- * All newborn infants must be kept warm
- * For thick meconium found in the amniotic fluid at the time of delivery or is present in the oropharynx, suction oropharynx and prepare for need for positive pressure ventilation via bag-valve-mask device
- * Meconium Aspiration Syndrome is a severe complication for the neonate
- * For meconium present at the time of delivery and the neonate has normal vital signs and demonstrates vigorous muscle activity
 - Use the bulb suction or appropriately sized suction catheter to suction oropharynx
- * For neonate that is depressed (apnea, heart rate < 100, and decreased muscle tone)
 - Provide positive pressure ventilation with bag-valve-mask device
 - Re-suction oropharynx as required
 - Suction should not last more than 3 to 5 seconds

Additional Considerations – Miscellaneous

- * Transport to patient's hospital of choice
 - For complications (hemorrhage, neonatal distress, abnormal delivery complication) divert to the closest hospital with OB/labor and delivery services within the requested healthcare system
 - Avoid free-standing emergency departments except in extreme circumstances and the free-standing ED is critically closer than closest hospital ED
 - These facilities do not have OB/labor and delivery services
- * Any pregnant patient involved in a MVC should be seen by a physician for evaluation
 - Greater than 20 weeks generally require 4 to 6 hours of fetal monitoring

- * When transporting to Atrium Health Carolinas Medical Center; the patient may be transported directly to Labor and Delivery (bypassing Triage and the ED) for patient ≥ 20 weeks in gestation (manifested by dates, ultrasound, or the uterus palpated above the navel) and any the following are present:
 - Indications
 - Abdomen, pelvic, or back pain
 - Signs and symptoms of labor or imminent delivery without crowning
 - Vaginal bleeding
 - Water has broken
 - Contraindications for transporting directly to L&D
 - Active seizures
 - Crowning or imminent delivery
 - Respiratory or cardiac arrest
 - Shock
 - Trauma
 - Contact CMC Labor and Delivery to provide report
 - Contact CMED at **704-598-2436** and request patch to CMC Labor and Delivery
 - If this fails, Radio - Provide report to ED and request information be communicated to Labor and Delivery
 - If this fails, Cellular - Dial direct at **704-355-2053**
 - The following minimum information should be communicated along with routine clinical findings:
 - Name
 - Date of birth
 - Name of Obstetric Clinic or Obstetrician
 - Last menstrual period
 - Delivery date
 - On arrival, proceed directly to the 8th floor
 - Labor and Delivery staff will be present on arrival to direct appropriate patient destination
 - Contact Medical Control for any of the following:
 - Unsure whether the patient meets appropriate criteria
 - Unable to contact Labor and Delivery
 - Clinical condition changes and destination directly to Labor and Delivery is contraindicated

Psychiatric / Behavioral (UP-17/18/19)

History

- * Drug/alcohol addiction/abuse
- * Psychiatric disorder diagnosis
- * Psychiatric medications
- * Situational crisis

Clinical Presentation

- * Agitation
- * Anxiety
- * Bizarre behavior or thought patterns
- * Combative or violent
- * Confusion
- * Delusions
- * Hallucinations
- * Homicidal thoughts
- * Suicidal thoughts

Differential Diagnosis

- * Adverse medication reaction
- * Anxiety disorder
- * Bipolar disorder
- * Depression disorder
- * Drug / Alcohol intoxication
- * Drug withdrawal
- * Hemodynamic instability
- * Hypoglycemia
- * Hypoxia
- * Infection
- * Medication effect
- * Medication overdose
- * Post-ictal seizure
- * Psychosis disorder (schizophrenia)
- * Trauma

Basic Medical Care

1. Ensure scene safety
 - A. Screen for weapons
 - i. Remove any objects in the immediate area which may be potential weapon
 - ii. Do not attempt to remove any weapon from patient
 - B. Maintain appropriate distance between you and patient per circumstances
 - C. Withdrawal a safe distance from patient as circumstances dictate (if patient becomes threatening or violent) and coordinate assistance
 - i. Maintain visualization of the patient from a safe distance
2. Remove patient from stressful environment & attempt to calm by reassurance
 - A. Utilize verbal de-escalation strategies (see accompanying section)
3. Establish rapport with patient
 - A. As safety permits limit number of providers assessing the patient at one time
 - B. Limit the amount of external stimuli
 - i. Radio communications
 - ii. Conversations by others on scene
4. Set limits in a positive, matter-of-fact; non-threatening manner
 - A. Ensure patient that providers are there to help
 - B. As indicated, inform patient that harm to self or providers will not be tolerated
5. [Medical Initial Assessment Protocol](#) or [Pediatric Initial Assessment Protocol](#)
6. Treat suspected trauma or medical illness per appropriate protocol
7. Assess vital signs as patient permits
8. Provide supplemental oxygen per patient condition to maintain SpO₂ = 94 – 97%
9. Provide assisted ventilations with bag-valve mask and 100% oxygen if breathing or ventilatory compromise is apparent
10. Assess blood glucose level
 - A. Oral glucose for hypoglycemia and patient alert with intact gag reflex
11. If restraints are required to control aggressive behavior, only use authorized restraints
 - A. Modification devices or attempting to restrain patients using so called “homemade” devices or techniques is prohibited
 - B. Tape will not be used unless required to secure an authorized restraint
 - C. Patients will **NEVER** be restrained prone (face down)
 - D. If patient is handcuffed by law enforcement, law enforcement officer must accompany patient in transport to the hospital
12. Personal protective masks may be applied to patients threatening to spit
13. For hanging or suspected trauma to head or spine
 - A. Immediately remove constricting device
 - B. Protect and maintain control of the cervical spine with manual motion restriction until cervical collar is placed and patient secured to transport stretcher
 - i. Cervical spinal cord and bony injuries are most common in hangings that involve a fall from a distance greater than the height of the victim
 - C. Suicidal hangings are typically strangulation events, representing vascular congestion and asphyxiation as causes of morbidity/mortality – though trauma must be considered; management is more often medical in nature

Advanced Medical Care

1. Apply 4-lead ECG and refer to appropriate protocol as indicated
2. Obtain 12-lead ECG as indicated per patient's presentation
3. IVF as indicated per patient condition
 - A. Adults:
 - i. Hemodynamically unstable: IVF wide open
 - ii. Hemodynamically stable: TKO
 - B. Pediatrics
 - i. Hemodynamically unstable: 10 – 20 ml/kg bolus and reassess
 - ii. Hemodynamically stable: TKO
4. For hypoglycemia, treat as per [Diabetic Problems Hypoglycemia Protocol](#)
5. Assess *Behavioral Activity Rating Scale (BARS)*

1	Difficult or unable to awaken
2	Asleep - normally responsive to voice or physical stimuli
3	Drowsy – appears sedated
4	Quiet and awake (normal activity)
5	Overt activity (verbal or physical) – calms with instructions
6	Extremely or continuously active – but not requiring restraint
7	Violent – requires restraint

6. For agitation associated with substance abuse/withdrawal or **BARS score 5-6**
 - A. Midazolam (Versed®)
 - i. Adults: 5 mg IV, IM or 10 mg IN
 - ii. Pediatrics: 0.15 mg/kg IV, IM (max 5 mg) or 0.2 mg/kg IN (max 10 mg)
 - iii. Repeat x1 as indicated per patient response
 - iv. Contact Medical Control for further sedation following 2nd dose
 - v. Nasal cannula ETCO₂ monitoring must be utilized
7. For significant agitation associated with **BARS score = 7** or extreme agitation
 - A. Ketamine (Ketalar®)
 - i. Adult: 3 mg/kg IM (maximum 300 mg)
 1. May repeat once after 5 minutes: 1.5 mg/kg IM (maximum 150 mg)
 - ii. Pediatric: must contact medical director or EMS fellow
 - iii. Nasal cannula ETCO₂ monitoring must be utilized
8. Contact medical control for any additional sedation administration for patients remaining significantly combative/agitated and/or posing risk to the patient and/or providers
9. For dystonic reaction following use of antipsychotic medication
 - A. Diphenhydramine (Benadryl®)
 - i. Adults: 25 – 50 mg IV, IM
 - ii. Pediatrics: > 9 months: 1 mg/kg IV, IM (maximum 25 mg)
10. Advanced Airway management as indicated
 - A. [Airway: Intubation Protocol](#)
 - B. [Airway: BIAD Protocol](#)
11. Ensure proper tube placement using capnometry, SpO₂ and ventilate with 100% oxygen
12. Additional care as indicated by patient presentation

Additional Considerations

- * Any patient receiving midazolam or ketamine for sedation must be transported to the emergency department (ketamine = hospital emergency department only)
- * Maintain a high index of suspicion of medical/traumatic cause of behavioral disturbance
 - Abnormal vital signs or new onset psychiatric symptoms should be considered to have a medical cause until proven otherwise
 - 12 – 25% of patients with behavioral symptoms have medical cause
- * Sedation medications will only be given for medical care concerns
- * Dystonic reactions
 - Characterized as an altered mental status displaying features of anxiety, facial grimacing, and torticollis (rigidity) of the neck
 - Typically results from antipsychotic medications (haloperidol - Haldol®, fluphenazine - Prolixin®), antiemetics (prochlorperazine - Compazine®)
- * Patient must have the mental capacity to refuse medical care
 - Contact Medical Control for any concerns as to the patient's level of capacity to comprehend risks of refusing care and benefits accepting care
- * Always be aware of the possibility of domestic violence and/or abuse
- * Documentation must include the indications for sedation administration – midazolam or ketamine

Hyperactive Delirium with Extreme Agitation

- * Signs/symptoms
 - Disorientation
 - Hallucinations
 - Hyper-aggression
 - Hyperthermia
 - Paranoia
 - Tachycardia
 - Possibly increased strength
- * Most commonly seen in males with history of mental illness and/or drug use
 - Especially with cocaine, crack, methamphetamine, or amphetamine use
- * Potentially life-threatening
- * Requires aggressive sedation and IVF
 - Often accompanied by rhabdomyolysis requiring IVF resuscitation
- * May involve hyperthermia requiring cooling measures
- * Physical restraints must be used with caution
 - Ensure patient does not continue to struggle against any physical restraints
 - Contact medical control for additional sedation orders
- * Sedation for patients noted to be extremely agitated should be emergently considered because rapid decompensation is possible
 - Contact medical control for additional sedation orders
- * Combative patients resulting from acute psychosis or intoxication are at increased risk for lactic acidosis, positional asphyxiation, and subsequent cardiac arrest
 - If physical restraints are necessary, such patients will always be placed and transported in the lateral or supine position (NEVER prone)
 - Restrained patients will never be left unattended

Verbal De-escalation Strategies

- * Protect personal space of the patient
 - Maintain distance from the patient (~4 – 6 feet)
 - Do not position yourself between patient and only exit
 - Provider and patient should have ability to exit without feeling “boxed-in”
- * Do not provoke the patient
 - Body language should convey that there is not intent to inflict harm
 - Hands/arm visible
 - Align at an angle to the patient
 - Avoid prolonged eye contact/staring
 - Ensure others on scene are not provoking the patient
- * Maintain verbal contact with the patient
 - Introduce provider(s) and explain provider role(s)
 - One provider should take lead and limit others conversing with the patient
 - Emphasize goal to keep the patient safe
 - Ask patient how they wish to be addressed
- * Be concise
 - Keep conversations short and simple
 - Allow time for patient to process information
 - Repeat statements as needed to ensure understanding
- * Identify patient’s needs/feelings
 - Ask why 911 was called; identifying the patient’s acute need
 - “How do you think we can help you today?”
 - “We would like to know what caused you to become upset so we can help”
- * Listen to the patient
 - As needed repeat back to the patient what they have said
 - “Let me make sure I understand what you said”
 - “Tell me if I have this right”
 - Ensure body language expresses that you are listening
- * Agree or agree to disagree
 - If statements deemed truthful, agree with those truths
 - Agree in principle if concern statements are not true
 - Do not agree with delusions – agree to disagree at that point
- * Set clear limits of behavior
 - Set limits in positive, non-threatening manner
 - Inform that patient harm to self or providers cannot/will not be tolerated
 - If behavior frightening to providers, inform patient their behavior is concerning
 - Remind patient providers are there to help but providers cannot be abused
- * Offer reasonable choices
 - Offer items of comfort: blanket, drink, etc.
 - Offer options of medication administration: PO, IV, IM, IN
- * Inform patient of potential interventions
 - If chemical or physical restraint may be required (why, how, what)

Atrium Health Behavioral Health Charlotte Transfers

- * Patients at the Atrium Health – Behavioral Health Charlotte may require additional medical screening or treatment for possible medical conditions
- * When MEDIC is requested to conduct these transports:
 - Prior to transfer, AHBHC staff will discuss medical clearance plans with the patient, collectively deciding on hospital destination
 - Upon MEDIC arrival, the physician or nurse will discuss the destination facility with the crew with the patient in attendance so that all agree
 - Ensure appropriate portions of the medical record accompany the patient to the destination hospital
 - If, while enroute, the patient changes their mind and requests an alternative destination; that request will **NOT** be honored – transport will continue to the previously determined destination
- * MEDIC personnel will not alter the destination decision
 - If patient condition changes while enroute such that it necessitates a change in destination, this must be immediately communicated (e.g. patient develops ST-segment elevation in route necessitating diversion to a PCI capable hospital)
- * If patient becomes aggressive or combative
 - Ensure crew safety
 - Utilize verbal de-escalation as outline above
 - *Assess Behavioral Activity Rating Scale (BARS)* with sedation as indicated as outlined above
 - Request local law enforcement for assistance as necessary

Community Policing Crisis Response Team

Purpose

- * Provide an alternate destination for patients with isolated psychiatric complaints who meet certain criteria
- * Permit EMS providers to safely leave a patient meeting criteria in the care of CMPD or the jurisdictional police department while awaiting Community Policing Crisis Response Team (CPCRT) or Community Mobile Crisis Team (CMCT) evaluation, with the understanding that at any time, EMS may be called to return to the scene

Introduction

- * The CPCRT is an initiative by the Charlotte Mecklenburg Police Department (CMPD) to provide an alternative to EMS transport to the emergency department for patients requiring mental health evaluation or treatment
- * CPCRT is typically available 0700 – 0200 within the jurisdiction of the CMPD
- * CPCRT is composed of licensed mental health workers that can arrange either outpatient treatment and resources or inpatient evaluation at a mental health facility, including involuntary commitment
- * For those patients deemed by CPCRT to require inpatient treatment, CPCRT also arranges transport to inpatient psychiatric facilities without utilizing EMS
- * CPCRT may be requested to respond to the scene by either CMPD or EMS providers on the scene of a mentally ill patient once police are also on scene
 - CPCRT may be requested either by speaking directly with the on-scene police officer or by contacting CMPD dispatch through CMED or the shift supervisor
- * CMCT which serves an identical role to the CPCRT outside of CMPD jurisdictions and may be requested to the scene by the jurisdictional police department
 - Police should be on scene before contact CPCRT and CMCT

Medical Care

1. Ensure scene safety
 - A. If determined it is unsafe to leave the patient in the care of police or CPCRT/CMCT without medical personnel, transport per appropriate protocol
2. [Medical Initial Assessment Protocol](#) or [Pediatric Initial Assessment Protocol](#)
3. Assess vital signs
4. Assess blood glucose level

5. The following criteria must be met
 - A. GCS = 15
 - B. Temperature < 101.0° F
 - C. HR = 60 – 120
 - D. SBP = 100 – 180
 - E. RR = 12 – 24
 - F. SpO₂ = 94 – 100%
 - G. Blood glucose level = 60 – 300
 - H. No “medical” complaints (e.g. chest pain, abdominal pain, etc.)
 - I. No external signs of trauma and no history of trauma reported by the patient, police, or bystanders
 - Includes, but not limited to: evidence of recent self-injury or strangulation
 - J. No evidence of ingestion, intoxication, or exposure and no history of ingestion, intoxication or exposure reported
 - Includes, but not limited to: ingestion of medication beyond what is instructed/prescribed
 - Includes, but not limited to: exposures to carbon monoxide or other toxic substances
 - Includes no medication administration by EMS
 - K. No acute agitation and no requirement for physical or chemical restraints
 - L. CPCRT or CMCT have been contacted and are available at the time
 - M. Police on scene and willing to assume responsibility for patient while awaiting CPCRT or CMCT

AND

 - N. Police ensure that the patient will not be left unattended unless deemed safe following CPCRT or CMCT evaluation
6. Unit may clear the call and become available under the premises of “cancellation”
 - A. With appropriate PCR documentation
7. If system status permits, EMS unit may remain on scene with the patient until evaluation has been completed by CPCRT or CMCT
 - A. Unit may then clear the call and become available under the premises of “cancellation”
 - With appropriate PCR documentation

Additional Considerations

- * CPCRT or CMCT may be contacted by CMPD or jurisdictional police prior to EMS arrival
 - Do not cancel CPCRT/CMCT unless the patient requires immediate transport to the hospital or does not meet all of the above criteria (#5)
- * CPCRT or CMCT may arrange transport to a psychiatric facility through CMPD or jurisdictional police or another resource
- * CPCRT or CMCT may deem the patient safe to stay on scene and not requiring additional evaluation/treatment and appropriate for outpatient resources and treatment

AH Behavioral Health Charlotte Destination Supplement

Introduction

- * This protocol is a supplement to the Psychiatric / Behavioral protocol
- * This protocol is a supplement to the Community Policing Crisis Response Team protocol
- * This protocol is intended to identify patients that are appropriate for transport directly to Atrium Health – Behavioral Health Charlotte Emergency Department

- * Patients must meet all inclusion criteria with no exclusion criteria as outlined below
 - AND**
 - * Patient requests transport to either Atrium Health’s CMC, AH-Mercy, or AH-South Park
 - OR**
 - * For patients without a preference and Atrium Health’s CMC, AH-Mercy, or AH-South Park is the closest facility per mobile mapping data

 - * For patients requesting any other Atrium Health facility (other than the three listed above) transport should be to that requested AH facility (AH-UC, AH-P, AH-SC, AH-H)
 - * For patients without a preference and an Atrium Health facility (other than the three listed above) or any Novant Health facility is the closest facility per mobile mapping, the patient should be transported to that closest facility

Inclusion Criteria

- * Isolated psychiatric / behavioral health complaint
 - Suicidal or homicidal ideation without current attempt
 - Abrasions from “cutting” not requiring any significant care are permitted
 - Known psychiatric disorder with exacerbation of symptoms
 - Known psychiatric disorder with auditory/visual hallucinations
 - Known psychiatric disorder with depression/mania symptoms
 - Psychiatric disorder with complaint of out of medications
- * Age > 12 < 65-years
- * GCS = 15
- * Temperature < 100.4° F
- * HR = 60 – 120
- * SBP = 100 – 180
- * RR = 12 – 24
- * SpO₂ = 94 – 100%
- * Negative EIDS field screen

Exclusion Criteria

- * Non-psychiatric complaints
 - e.g. chest pain, abdominal pain, shortness of breath, any new onset pain
- * External signs of trauma or history of trauma reported by the patient, police or bystanders
 - Includes, but not limited to: evidence of recent self-injury or strangulation
 - Lacerations from “cutting” requiring repair are excluded
- * Evidence of ingestion, intoxication, or exposure or history of ingestion, intoxication or exposure reported
 - Includes, but not limited to: ingestion of medication beyond what is instructed/prescribed
 - Includes, but not limited to: exposures to carbon monoxide or other toxic substances
- * Any medication administration by EMS
- * Acute agitation or requirement for physical or chemical restraints
- * Positive EIDS field screen
- * COVID-19 testing performed with unknown result
 - If tested at an Atrium Health testing site; contact medical control at CMC to see if results are available

Basic Medical Care

1. Ensure scene safety
2. [Medical Initial Assessment Protocol](#) or [Pediatric Initial Assessment Protocol](#)
3. Remove patient from stressful environment & attempt to calm by reassurance
4. Treat per standard psychiatric – behavioral health protocol
5. Assess vital signs
6. Assess blood glucose level
 - A. Treatment as indicated per [Diabetic Problems Protocol](#)
7. When transporting directly to AH-BHC report should be called via CMED patch to:
 - A. Primary contact: AH-BHC charge nurse @ 704-444-5975
 - B. Secondary contact: AH-BHC ED desk @ 704-358-2800
8. Completed PCRs will be faxed to HIPAA secure fax @ 704-444-2515

Additional Considerations

- * Appropriate patients should be referred to the Community Policing Crisis Response Team thereby potentially eliminating any need for transport
- * Discussion should occur with CMPD on scene for possible transport by CMPD to AH-BHC
- * Upon arrival to AH-BHC
 - Follow signs clearly marking the Emergency entrance
 - Parking area and entry door that to utilize are to the far left of the building
 - Parking area for use is marked as “Law Enforcement Parking”
 - Units will either back into the area or pull directly in to space
 - Door for entry to the building will be directly to the right
 - Providers will assist the patient in exiting the unit and walk them inside
 - Wheelchairs are available if necessary
 - The door is secured and locked and crews will need to ring the bell, with having called report ahead of time, security will be awaiting their arrival
 - Once entry to the ED is made, the first room on the right will be where EMS patients are triaged and report taken by nursing or physician staff
 - Their report will be signed upon completion of verbal report

Sick Person

Differential Diagnosis

- * Behavioral disorder
- * Blood pressure abnormality
- * Brief Resolved Unexplained Event
- * Cancer
- * Cerebrovascular accident
- * Cholecystitis
- * Diabetic condition
- * Electrolyte abnormality
- * Gastroenteritis
- * Hepatitis
- * HIV or AIDS
- * Hypertension
- * Infection
- * Inflammatory illness
- * Medication reaction
- * Pancreatitis
- * Pneumonia
- * Renal Failure
- * Sepsis
- * Sickle Cell Pain Crisis
- * Substance abuse
- * Ulcer disease
- * Viral syndrome

Basic Medical Care

1. [Medical Initial Assessment Protocol](#) or [Pediatric Initial Assessment Protocol](#)
2. Maintain airway; suction as needed
3. Assess vital signs including temperature
4. Provide supplemental oxygen per patient condition to maintain SpO₂ = 94 – 97%
5. Provide assisted ventilations with bag-valve mask and 100% oxygen if breathing or ventilatory compromise is apparent
6. Assess blood glucose level
 - A. Oral glucose for hypoglycemia and patient alert with intact gag reflex
7. Additional care per provider determined primary and/or secondary impression

Advanced Medical Care

1. Obtain 4-lead ECG and refer to appropriate protocol as indicated
2. Obtain 12-lead ECG for patient's presentation consistent with cardiac ischemia
3. IVF as per patient condition
 - A. Adults:
 - i. Hemodynamically unstable: IVF wide open
 - ii. Hemodynamically stable: TKO
 - B. Pediatrics:
 - iii. Hemodynamically unstable: 10 - 20 ml/kg bolus and reassess
 - iv. Hemodynamically stable: TKO
4. For persistent hypotension following adequate IVF resuscitation
 - A. Dopamine @ 10 – 20 mcg/kg/min
5. Additional care per provider determined primary and/or secondary impression

Sickle Cell Anemia Related Crisis

Sickle cell disease related events

- * Acute chest syndrome
 - Young patients
 - Chest pain, fever, cough, tachypnea, hypoxemia
- * Acute pain crisis
 - Most common clinical manifestation (vaso-occlusive crisis) with SCD
 - Triggers: hypoxia, dehydration, temperature (inc or dec; patient or ambient)
- * Aplastic anemia
- * Avascular necrosis
 - Femoral, humeral heads
- * Cholelithiasis
- * Chronic pain
- * Hemolytic anemia
- * Infection
- * Priapism
- * Pulmonary hypertension
- * Stroke

Advanced Medical Care – Vaso-occlusive Pain Crisis

1. IVF as per patient condition
 - A. Adults:
 - i. Hemodynamically unstable: IVF wide open
 - ii. Hemodynamically stable: 250 ml bolus and reassess
 - B. Pediatrics
 - i. Hemodynamically unstable: 10 – 20 ml/kg bolus and reassess
 - ii. Hemodynamically stable: 10 ml/kg bolus and reassess
2. Fentanyl for pain control
 - A. Adults:
 - i. 1 – 2 mcg/kg IN (maximum 200 mcg)
 - ii. 0.5 – 1 mcg/kg IV, IM (maximum 100 mcg)
 - iii. May repeat x1 in 15 minutes as indicated (maximum 100 mcg any route)
 - B. Pediatrics:
 - i. 0.5 – 1 mcg/kg IV, IM, IN (maximum 100 mcg)
 - ii. Contact Medical Control for repeat dosing
3. Alternate analgesic: nitrous oxide via patient-controlled inhalation

Advanced Medical Care – Acute Chest Syndrome

1. Provide supplemental oxygen per patient condition to maintain SpO₂ = 94 – 97%
2. Pain control as for vaso-occlusive crisis

Fever (UP-10)

Differential Diagnosis

- * Drug intoxication (cocaine, methamphetamine)
- * Hyperthermia (environment)
- * Hyperthyroidism
- * Infection
- * Lymphoma, cancer
- * Medication reaction

Basic Medical Care

1. Antipyretic
 - A. Acetaminophen (Tylenol®) – ensure patient should not be NPO
 - i. Adults: 650 – 975 mg PO
 - ii. Pediatrics: 15 mg/kg PO (maximum 650 mg)
 - B. Ibuprofen (Motrin®) – ensure patient should not be NPO
 - i. Adults: 400 – 800 mg PO
 - ii. Pediatrics (> 6 months): 10 mg/kg PO (maximum 400 mg)
2. Ibuprofen and acetaminophen are NOT indicated in instances of elevated temperature as the result of heat related emergencies

Advanced Medical Care

1. IVF administration as indicated per patient condition
2. Additional care per appropriate protocol per patient presentation

Additional Considerations

- * Droplet precautions:
 - Standard PPE + surgical mask for providers who accompany patients in the back of the ambulance and surgical mask or NRB O₂ mask for the patient
 - Should be utilized when influenza, meningitis, mumps, streptococcal pharyngitis, and other illnesses spread via large particle droplets are suspected
- * Airborne precautions:
 - Include standard PPE + gown and change of gloves after every patient contact, and strict hand washing precautions
 - Should be utilized when multi-drug resistant organisms (e.g. MRSA), scabies, or zoster (shingles), or other illnesses spread by contact are suspected
- * All-hazards precautions:
 - Standard PPE + airborne precautions + contact precautions
 - Should be utilized during the initial phases of an outbreak when the etiology of the infection is unknown or when the causative agent is found to be highly contagious (e.g. SARS, Ebola)

Vomiting or Diarrhea (UP-3)

Differential Diagnosis

* Vomiting

- Appendicitis
- Bowel obstruction
- Cholecystitis
- Closed head injury
- DKA
- Food-born toxin
- Gastroparesis
- Glaucoma
- Increased intracranial pressure
- Inflammatory bowel disease
- Intoxication
- Irritable bowel syndrome
- Medications
- Migraine
- Myocardial infarction
- Pain
- Pancreatitis
- Pregnancy
- Renal calculi
- Urinary tract infection
- Vestibular disorder
- Viral gastroenteritis

* Diarrhea

- Bacterial enteritis
- Gastric bypass
- Inflammatory bowel disease
- Laxative abuse
- Malabsorption
- Medications
- Mesenteric ischemia
- Viral gastroenteritis

Advanced Medical Care

1. Obtain 4-lead ECG and refer to appropriate protocol as indicated
2. Obtain 12-lead ECG as indicated per patient's presentation
3. IVF as per patient condition
 - A. Adults:
 - i. Hemodynamically unstable: IVF wide open
 - ii. Hemodynamically stable: TKO – 500 ml bolus and reassess
 - B. Pediatrics
 - i. Hemodynamically unstable: 10 – 20 ml/kg bolus and reassess
 - ii. Hemodynamically stable: TKO – 10 m;/kg bolus and reassess
4. Ondansetron (Zofran®)
 - A. Adults: 4 – 8 mg IV, IM, PO
 - B. Pediatrics: 0.15 mg/kg IV, IM, PO (maximum 4 mg)
5. Assess blood glucose level and treat as per [Diabetic Protocol](#)
6. Treat any associated abdominal pain as per [Abdominal Pain Protocol](#)

Sepsis / Suspected Bacterial Infection (UP-15)

Signs and Symptoms

- * Abdominal pain
- * Altered mental status
- * Fatigue / tired
- * Fever / chills
- * Generalized weakness
- * Hyperthermia (temp > 100°F or "hot to touch")
- * Hypothermia (temp < 96°F or "cold to touch")
- * Localized redness/swelling
- * Productive cough

Potential infection

- * Bacteremia
- * Cellulitis/Abscess
- * Indwelling device (central line, PICC, Foley catheter)
- * Intra-abdominal infection
- * Meningitis
- * Pneumonia
- * Urinary tract infection (UTI)
- * Wound infection

Advanced Medical Care

1. Obtain 4-lead ECG and refer to appropriate protocol as indicated
2. Calculate shock index (HR/SBP)
3. High risk
 - A. Shock index ≥ 1
 - B. Hypotension (SBP < 100; MAP < 65 mmHg)
 - C. HR > 120
 - D. GCS ≤ 14
 - E. For high risk of serious bacterial infection, provide IVF resuscitation
 - i. Adults: IVF wide open; goal = 30 ml/kg
 - ii. Pediatrics: 10 – 20 ml/kg bolus and reassess
4. Medium risk
 - A. Shock index 0.99 – 0.8
 - B. For medium risk of serious bacterial infection, provide IVF resuscitation:
 - i. 10 – 20 ml/kg and reassess
5. Low risk
 - A. No identified objective criteria
6. For persistent hypotension following adequate IVF resuscitation
 - A. Dopamine @ 10 – 20 mcg/kg/min

Additional Considerations

- * Sepsis indicators
 - Altered mental status
 - Hypotension (SBP < 100 or MAP < 65 mmHg)
 - Hypoxia (SpO₂ < 90%)
 - Tachycardia (HR > 100)
 - Tachypnea (RR > 20)
 - Temperature (> 101.0°F or < 96.8°F)
- * Sepsis = life threatening condition where the body's immune response to infection injures its own tissues and organs
- * Severe sepsis = known or suspected infection with systemic manifestations of sepsis along with sepsis-related tissue hypo-perfusion or organ dysfunction
- * Septic shock = severe sepsis and poor perfusion (MAP < 65 mmHg or elevated lactate) unimproved after fluid bolus
- * Droplet precautions:
 - Standard PPE plus
 - Standard surgical mask for providers who accompany patients in the back of the ambulance
 - Surgical mask or NRB O₂ mask for the patient
 - Should be utilized when influenza, meningitis, mumps, streptococcal pharyngitis, and other illnesses spread via large particle droplets are suspected
- * Airborne precautions:
 - Include standard PPE plus
 - Gown
 - Change of gloves after every patient contact, and strict hand washing precautions
 - Should be utilized when multi-drug resistant organisms (e.g. MRSA), scabies, or zoster (shingles), or other illnesses spread by contact are suspected
- * All-hazards precautions:
 - Standard PPE plus
 - Airborne precautions plus
 - Contact precautions
 - Should be utilized during the initial phases of an outbreak when the etiology of the infection is unknown or when the causative agent is found to be highly contagious (e.g. SARS, Ebola)



Dialysis / Renal Failure (AM-3)

Advanced Medical Care

1. Assess fluid status: IVF bolus for suspected hypovolemia post hemodialysis
 - A. Adults: 250 – 500 ml IV and reassess
 - B. Pediatrics: 10 ml/kg IV and reassess
 - C. Provide supplemental oxygen per patient condition to maintain SpO₂ = 94 – 97%
2. Monitor vital signs frequently with continuous ECG monitoring
3. 12-lead ECG as indicated per patient presentation
4. For presumed hyperkalemia
 - A. Adults
 - i. Calcium gluconate 2 grams (20ml of 10% solution) IV, IO
 - ii. Sodium bicarbonate 50 mEq (50 ml) IV, IO
 - iii. Albuterol 5 mg via nebulizer
 - B. Pediatrics
 - i. Calcium gluconate 20 mg/kg IV, IO (0.2 ml/kg of 10% solution); maximum 2 grams (20 ml)
 - ii. Sodium bicarbonate 1 mEq/kg (1 ml/kg) maximum 50 mEq (50 ml) IV, IO
 - iii. Albuterol 2.5 – 5 mg via nebulizer
5. Control access site hemorrhage with direct pressure (do not compress the fistula/shunt)
 - A. Persistent bleeding: consider MEDIC tourniquet place proximal to the shunt **NOT** on the bleeding source per [Wound Care – Tourniquet Protocol](#)
7. For persistent hypotension
 - A. Dopamine @ 10 – 20 mcg/kg/min

Additional Considerations

- * Avoid IV access or blood pressure measurements in extremity with a shunt or fistula
- * Consider post-dialysis complications
 - Bleeding
 - Disequilibrium
 - Electrolyte shifts causing weakness, dizziness, nausea/vomiting, seizures
 - Hypotension
- * Hyperkalemia symptoms: fatigue, muscle weakness, nausea/vomiting, paresthesias
- * Hyperkalemia ECG changes
 - T-waves peaked
 - P-wave loss
 - PR prolongation
 - QRS widening
 - AV block
 - Bradycardia
 - Sine wave
 - Ventricular fibrillation

Serum Potassium	Typical ECG Appearance	Possible ECG Abnormalities
Mild (5.5-6.5 mEq/L)		Peaked T waves Prolonged PR segment
Moderate (6.5-8.0 mEq/L)		Loss of P wave Prolonged QRS complex ST-segment elevation Ectopic beats and escape rhythms
Severe (> 8.0 mEq/L)		Progressive widening of QRS complex Sine wave Ventricular fibrillation

Hypertension (AM-4)

Historical Considerations

- * Diagnosed hypertension
- * Compliance with medications for hypertension
- * Pregnancy
- * Renal failure

Advanced Medical Care

1. 4-lead ECG and refer to appropriate protocol as indicated
2. 12-lead ECG as indicated per patient presentation
3. Assess for evidence of hypertensive crisis
 - A. Signs
 - Systolic BP > 185 mm Hg
 - Diastolic BP > 110 mm Hg
 - Measured on two occasions > 5 minutes apart
 - B. Symptoms
 - Altered mental status
 - Cerebrovascular accident
 - Chest pain
 - Congestive heart failure
 - Renal failure
 - Seizure
4. Labetalol 20 mg IV for hypertensive crisis for:
 - A. Altered mental status
 - B. Pre-eclampsia/eclampsia
 - C. CVA: per Medical Control order
5. Nitroglycerin for hypertensive crisis for:
 - A. Chest pain
 - B. CHF
6. Advanced Airway management as indicated
 - A. [Airway: Intubation Protocol](#)
 - B. [Airway: BIAD Protocol](#)
7. Ensure proper tube placement using capnometry, SpO₂ and ventilate with 100% oxygen
8. Additional care as indicated by patient presentation

Additional Considerations

- * Asymptomatic elevated blood pressure does NOT require emergent treatment to lower the blood pressure
- * Elevated blood pressure that is the result of respiratory distress (COPD, asthma) requires aggressive treatment of the respiratory distress NOT the blood pressure

Hypotension / Shock (AM-5/PM-3)

History considerations

- * Allergic reaction – anaphylaxis
- * Blood loss – GI bleeding, vaginal bleeding, intra-abdominal bleeding (AAA, ectopic)
- * Fever
- * Fluid loss – vomiting, diarrhea
- * Medications
- * Pregnancy

Advanced Medical Care

1. 4-lead ECG and refer to appropriate protocol as indicated
2. 12-lead ECG as indicated per patient presentation
3. Identify the cause of shock – management depends on the underlying cause of shock
 - A. Cardiogenic:
 - i. For volume depleted: IVF bolus
 - Adults 250 – 500 ml and reassess
 - Pediatrics 20 ml/kg and reassess
 - ii. For persistent hypotension
 - Dopamine @ 10 – 20 mcg/kg/min
 - iii. For volume overloaded
 - Dopamine @ 10 – 20 mcg/kg/min
 - B. Hypovolemic:
 - i. IVF resuscitation
 - Adults: wide open
 - Pediatrics 20 ml/kg – may repeat x2 boluses per patient condition
 - ii. Treat any potential trauma (hemorrhagic shock) per appropriate protocol
 - C. Distributive (vasogenic):
 - i. IVF resuscitation
 - Adults: wide open
 - Pediatrics 20 ml/kg – may repeat x2 boluses per patient condition
 - ii. For persistent hypotension
 - Dopamine @ 10 – 20 mcg/kg/min
 - D. Obstructive
 - i. For suspected tension pneumothorax perform chest needle decompression
 - ii. For suspected cardiac tamponade administer IVF bolus
4. Additional care as per appropriate presumptive diagnosis protocol

Additional Considerations

- * Hypovolemic Shock
 - Medical or surgical condition in which rapid fluid loss results in multiple organ failure due to inadequate circulating volume and subsequent inadequate perfusion
 - Cutaneous fluid loss (burns, excessive sweating)
 - Gastrointestinal fluid loss (vomiting, diarrhea)
 - Hemorrhage
 - Renal fluid loss (diabetes, diuretics)
- * Cardiogenic Shock
 - Decreased cardiac output and evidence of tissue hypoxia in the presence of adequate intravascular volume
 - Beta-blocker overdose
 - Calcium channel blocker overdose
 - Cardiomyopathy
 - Dysrhythmia
 - Infarction
 - Myocardial dysfunction
 - Myocardial toxicity
 - Tricyclic antidepressant overdose
 - Valvular incompetence
- * Vasogenic Shock
 - Excessive vasodilation and the impaired distribution of blood flow
 - Anaphylaxis
 - Drug toxicity
 - Sepsis
- * Neurogenic Shock
 - Specific form of vasogenic shock related to loss of sympathetic tone
 - Spinal cord injury
- * Other Shock States
 - Adrenal crisis
 - Aortic dissection
 - Cardiac tamponade
 - Pulmonary embolus
 - Tension pneumothorax
 - Vena cava obstruction
- * Undifferentiated Shock in the Medical Patient
 - Myocardial dysfunction (ECG changes, dysrhythmia, JVD, murmur)
 - Unexplained shock (sepsis, drug ingestion, adrenal crisis)
 - Volume depletion (dry mucous membranes, poor skin turgor)

Adrenal Crisis

- * Symptoms: vomiting, abdominal pain, and shock
- * Requires IVF resuscitation
 - Adults: IVF wide open
 - Pediatrics: 10 – 20 ml/kg bolus and reassess
- * If patient has specific medication available for adrenal crisis:
 - Hydrocortisone (Solu-Cortef®) this may be given per the prescribing physician's documented instructions
 - Typical dosing
 - < 1-year: 25 mg IV, IO, IM
 - 1-12 years: 50 mg IV, IO, IM
 - > 12 years: 100 mg IV, IO, IM
- * If no patient specific medication available:
 - Dexamethasone
 - Adults: 16 mg IV, IM, PO
 - Pediatrics: 0.6 mg/kg IV, IM, PO (maximum 16 mg)

Additional Considerations

- * Shock in the Trauma Patient
 - Aortic transection
 - Cardiac tamponade
 - Hemorrhage
 - Myocardial contusion
 - Spinal cord injury
 - Tension pneumothorax

Emergencies Involving Indwelling Central Lines (UP-8)

Catheter Types

- * Broviac®
- * Hickman®
- * Groshong®
- * Permacath / Vas cath
- * PICC – peripherally inserted central catheter

Basic Medical Care

1. [Medical Initial Assessment Protocol](#) or [Pediatric Initial Assessment Protocol](#)
2. Assess vital signs
3. Ensure catheter secured

Advanced Medical Care

1. Clean catheter port in standard aseptic fashion
2. Unclamp catheter
3. Attempt flush with sterile saline
4. Assess for infiltration
 - A. If present, stop infusion of any fluids, medications
5. Assess for hemorrhage at catheter insertion site
 - A. If present, apply direct pressure
6. Assess for evidence of air embolus
 - A. If present, position patient on left side with head down
 - B. Stop infusion
 - C. Clamp off catheter
7. If no difficulties: IVF or medication per appropriate protocol
8. Additional care as per appropriate medical condition protocol

Additional Considerations

- * Do not place a BP cuff or tourniquet on the same side as a peripherally inserted central line (PICC)
- * Catheter may be accessed in times of cardiac arrest for ACLS medication administration
 - Hickman®, Broviac®
 - PICC line
 - Permacath, Vas cath hemodialysis catheter (non-tunneled hemodialysis catheter)
- * Implanted devices (fully beneath the skin), such as a port-a-cath are **NOT** to be accessed by MEDIC personnel
 - These devices require specialized equipment and training for accessing

- * Broviac[®], Hickman[®], Groshong[®]
 - Tunneled catheters
 - Single, double or triple lumens
 - Broviac[®] typically smaller internal diameter for pediatrics
 - Groshong[®] has 3-way valve at distal end which remains closed when not being use

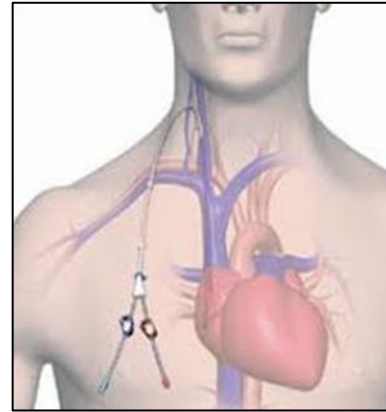

- * Permacath
 - Tunneled hemodialysis catheter
 - Vascath = non-tunneled catheter

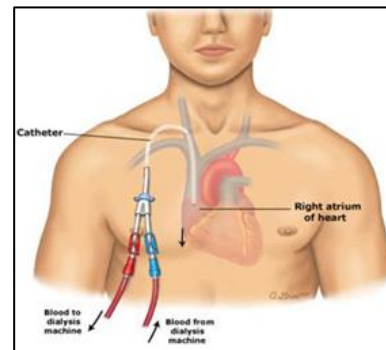

- * PICC
 - Peripherally inserted central catheter

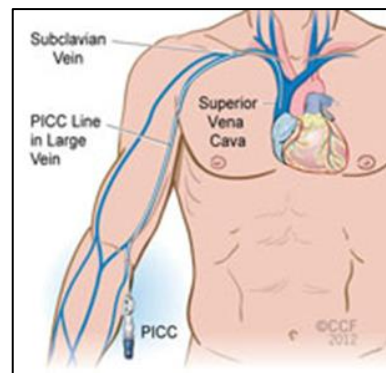

- * Portacath
 - Full implanted device
 - Requires Huber needle for access

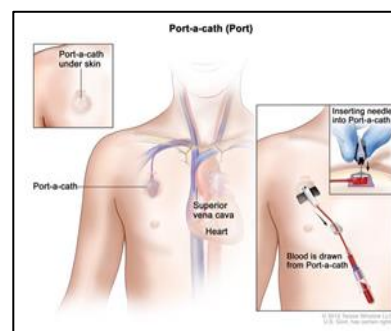

Brief Resolved Unexplained Event (BRUE)

Introduction

- * Sudden, brief (less than one minute), resolved episode including at least one of the following:
 - Cyanosis or pallor
 - Absent, decreased, or irregular breathing
 - Marked change in muscle tone (hyper- or hypotonia) or altered responsiveness
- * Occurs in infants < 1 year of age
- * Infants may appear normal after the episode
- * Associated with gastroesophageal reflux disease, viral lower respiratory tract infection, pertussis, sepsis and/or meningitis, seizures, metabolic disorders, toxic ingestion, cardiac dysrhythmia (e.g., long QT syndrome, SVT), anemia, nonaccidental trauma, or structural CNS, cardiac (ductal-dependent lesion), or airway anomaly
- * Infants are at risk for sudden infant death syndrome
- * Infant should always be transported
 - Any parent/guardian (patient) initiated refusal should be discussed with medical control prior to non-transport

Basic Medical Care

1. [Pediatric Initial Assessment Protocol](#)
2. Maintain airway; suction as needed
3. Assess vital signs
4. Provide supplemental oxygen per patient condition to maintain SpO₂ = 94 – 97%
5. Provide assisted ventilations with bag-valve mask and 100% oxygen if breathing or ventilatory compromise is apparent

Advanced Medical Care

1. Assess blood glucose level
 - A. Treatment as per [Diabetic Problems Protocol](#)
2. 4-lead ECG and refer to appropriate protocol as indicated
3. Additional care per provider determined presumptive diagnosis

Suspected Viral Hemorrhagic Fever (sc-1)

Introduction

- * Transmission occurs via contact with blood/body fluids of infected individuals including:
 - Blood
 - Breast milk
 - Secretions (saliva/sweat)
 - Semen
 - Urine
 - Vomitus/diarrhea
- * Incubation period is 2 – 21 days (not transmitted prior to onset of symptoms)
- * Symptoms:
 - Abdominal pain
 - Anorexia
 - Bleeding
 - Diarrhea
 - Fever (>100.4°F)
 - Headache
 - Joint and muscle aches
 - Vomiting
 - Weakness
- * Patients with any of the above signs/symptoms should specifically be asked if he/she has traveled to area with known viral hemorrhagic fever (e.g. Ebola) in the past 21-days
 - If positive travel, specifically ask country(ies) of travel
- * Consider that at-risk countries of travel may change with time
- * Other Potential highly infectious diseases
 - Ebola – west Africa
 - Lassa – west Africa
 - Marburg – south central Africa
 - MERS (Middle East Respiratory Syndrome) – Arabian Peninsula
 - SARS (Severe Acute Respiratory Syndrome)
 - Nipah Virus – southeast Asia
 - Smallpox
- * Differential diagnosis
 - Bacteremia/septicemia
 - Malaria
 - Meningococemia
 - Typhoid fever

Basic / Advanced Medical Care

1. EMS personnel should don personal protective equipment (PPE) with any patient with a positive screen (symptoms and travel to area of known outbreak in past 21 days) as soon as identified utilizing standard donning procedures for droplet/contact precautions (prior to patient contact if positive screen per CMED):
 - A. Eye protection (goggles / face shield)
 - B. Fluid impervious gown or (Tyvek) full coveralls
 - C. Gloves
 - D. N-95 mask
 - E. Shoe/boot and head covers (if not included with coveralls)
2. Only essential personnel should have any contact with the patient
3. First responder personnel should **not** have patient contact unless critical intervention / assistance required
4. Surgical mask should be placed on any patient with a positive screen for potential highly infectious disease (symptoms + travel)
 - A. Impermeable sheet should be utilized around patient as barrier between patient and EMS equipment/personnel
5. Care as per appropriate protocol (note advisements in #6 below)
6. Do **NOT** perform the following procedures
 - A. Aerosolizing procedure (nebulizer treatments, suctioning, CPAP)
 - B. Blood draw
 - C. Endotracheal intubation, BIAD, BVM
 - D. IM medication administration
 - E. IV/IO access
7. If supplemental oxygen is required a non-rebreather mask should be utilized
8. Limit utilized equipment to only essential equipment required for needed patient care
9. If positive screen identified, destination will be limited to **CMC or NHPMC** (based on patient hospital system of preference; if no preference, transport to closest (**CMC or NHPMC**) per mobile mapping data)
 - A. Contact medical control as soon as a patient with a positive screen is identified
 - B. Provide report to attending physician
 - C. Determine specific portal of entry per facility recommendations
 - D. Upon arrival to destination facility do NOT enter the facility
 - E. Crew will be met by hospital staff in the ambulance bay and patient will be transferred from EMS stretcher to hospital bed in the ambulance bay
10. With negative screen provide care as per appropriate protocol and transport per patient destination general triage protocol

Additional Considerations

- * CMED will screen at call-taking (CMED will advise "Positive EIDS patient" if positive screen)
 - It is imperative that field providers also ask screening questions on scene
- * Transport of patient with suspected highly infectious disease must be reported to Operations Supervisor
 - Highly infectious disease must be reported to local, state, and federal public health authorities
 - Ensure Public health notified of any patient who refuses transport or is pronounced dead on scene (if positive screen for a highly infectious disease)
- * If personnel sustain any exposure to patient blood, body fluids, secretions, or excretions immediately wash affected area with soap and water
 - Discontinue any patient care activities to wash / irrigate the affected site
 - Any mucous membrane exposure should receive copious irrigation
- * Extreme care should be utilized in doffing PPE post transport per standard procedure to ensure no contamination from exposure to used PPE
 - Do not touch outer surface of PPE
 - Do not remove N-95 mask or eye protection prior to gown/coverall removal
- * Appropriate PPE is required during cleaning / disinfecting of any EMS equipment
 - Utilize appropriate approved disinfectant cleansing solution
 - Equipment includes ambulance interior and surfaces exposed to patient contact
- * Following patient care activity utilize standard hand hygiene utilizing soap and water for 30 seconds or alcohol-based hand wash
- * If any personnel exposure occurs notify employee health as soon as feasible following decontamination / cleansing / irrigation of exposure

High Consequence Pathogens (SC-2)

Introduction

- * Patients should specifically be asked if he/she has had close contact with a diagnosed patient in the past 14-days
 - Or ask if close contact with person(s) who have traveled to at risk locations or is being evaluated for potential emerging infectious disease
- * Differential diagnosis
 - COVID-19 (Coronavirus)
 - Influenza
 - MERS (Middle East Respiratory Syndrome) – Arabian Peninsula
 - SARS (Severe Acute Respiratory Syndrome) – Asia
 - Bacteremia/septicemia
- * Transmission occurs via contact with respiratory droplets of infected individuals:
 - Between people who are in close contact with one another
 - ~ 3 – 6 feet for ≥ 10 minutes
 - COVID-19
 - It may be possible that a person can get COVID-19 by touching contaminated surface or object that has the virus on it and then touching their own mouth, nose, or eyes
 - This is not believed to be the main way the virus spreads
- * Symptoms:
 - Fever ($>100.4^{\circ}\text{F}$)
 - Cough/upper respiratory illness symptoms
 - Difficulty breathing or shortness of breath
 - Chills
 - Loss of sense of taste or smell
 - New headache
 - New myalgias
 - Nasal congestion/rhinorrhea
 - Nausea/vomiting/diarrhea
- * Consider that at-risk countries of travel may change with time ****
- * Other Potential highly infectious diseases
 - Ebola – west Africa
 - Lassa – west Africa
 - Marburg – south central Africa
 - Nipah Virus – southeast Asia
 - Smallpox

Basic / Advanced Medical Care

1. Screening on scene should take place for ALL patients (medical and trauma)
2. EMS personnel should don personal protective equipment (PPE) with any patient with a positive field screen (symptoms or known exposure) as soon as identified utilizing standard donning procedures for airborne/droplet precautions
 - A. Eye protection (goggles / face shield)
 - B. Fluid impervious gown
 - C. Gloves
 - D. N-95 mask (surgical mask may be utilized if N-95 mask is not available)
3. For CMED EIDS screen positive – one provider should don a surgical mask with face shield
 - A. Hand the patient a surgical mask to don
 - B. Perform a Field Screen within 5 minutes to verify EIDS status
 - C. For field screen positive ALL care providers who will be within 6 feet of patient must don full PPE
 - D. For field screen negative follow standard PPE guidelines
4. For field screen positive
 - A. Only essential personnel should have any contact with the patient
 - B. First responder personnel should **NOT** have patient contact unless critical intervention / assistance required
5. Surgical mask should be placed on all patients
6. Contact operations supervisor as soon as a patient with a positive screen is identified
7. Care as per appropriate protocol (note advisement in #9)
8. Avoid aerosolizing procedures if not distinctly indicated
 - A. Nebulizer treatments, suctioning, high flow nasal cannula, CPAP, SGD, BVM
 - B. **If any aerosolizing procedure is required, PPE as above with an N-95 mask must be utilized**
 - C. Avoid attempts at endotracheal intubation
9. If supplemental oxygen is required a non-rebreather mask should be utilized
10. Limit utilized equipment to only essential equipment required for needed patient care
11. With negative screen provide care as per appropriate protocol and transport per patient destination general triage protocol
12. During encode notify receiving emergency department of "EIDS positive patient"

Additional Considerations

- * Driver of transporting ambulance should wear PPE as described above when participating in patient care activities (including patient transport & loading)
 - Remove PPE except for N-95 (or surgical mask) and perform hand hygiene prior to entering vehicle cab to prevent contamination of driver's compartment
- * CMED will screen at call-taking (CMED will advise "Positive EIDS patient" if positive screen)
 - It is imperative that field providers also ask screening questions on scene
 - Transport of patient with suspected high consequence pathogen must be reported to Operations Supervisor (must be reported to local public health authorities)
 - Notify Supervisor and Public Health any patient who refuses transport or is pronounced dead on scene (if positive screen for a high consequence pathogen)

- * Extreme care should be utilized in doffing PPE post transport per standard procedure to ensure no contamination from exposure to used PPE
 - Do not touch outer surface of PPE
 - Do not remove N-95 mask or eye protection prior to gown/coverall removal
- * No family members or bystanders should be transported in the ambulance
- * Appropriate PPE is required during cleaning / disinfecting of any EMS equipment
 - Utilize appropriate approved disinfectant cleansing solution
 - Equipment includes ambulance interior and surfaces exposed to patient contact
- * Following patient care activity utilize standard hand hygiene utilizing soap and water for 30 seconds or alcohol-based hand sanitizer
- * If any personnel exposure occurs Supervisor will perform a risk assessment and notify employee health as indicated following decontamination/cleansing / irrigation of exposure
- * Recommended to wear surgical mask and consider eye protection for any patient with fever; even outside this protocol
- * Negative Pressure in care compartment:
 - For door or window available to separate driver's and care compartment space:
 - Close door/window between driver's and care compartment
 - Operate rear exhaust fan on full
 - For no door or window available to separate driver's and care compartment space:
 - Open outside air vent in driver's compartment and set rear fan to full
- * Set vehicle ventilation system to non-recirculating Airborne precautions
 - Standard PPE with fit-tested N95 mask (or PAPR respirator) and utilization of a gown, change of gloves after every patient contact, and strict hand washing precautions
 - Utilized with Aspergillus, Tuberculosis, Measles (rubeola) Chickenpox (varicella-zoster), Smallpox, Influenza, Rhinovirus, Norovirus, and Rotavirus, or zoster (shingles)
- * Contact precautions
 - Standard PPE with utilization of a gown, change of gloves after every patient contact, and strict hand washing precautions
 - Utilized with GI complaints, blood or body fluids, C diff, scabies, wound and skin infections, MRSA
 - Clostridium difficile (C diff) is not inactivated by alcohol-based cleaners and washing with soap and water is indicated
- * Droplet precautions
 - Standard PPE plus a standard surgical mask for providers who accompany patients in the treatment compartment and a surgical mask or NRB O2 mask for the patient
 - Utilized when Influenza, Meningitis, Mumps, Streptococcal pharyngitis, Pertussis, Adenovirus, Rhinovirus, SARS, and undiagnosed rashes
- * All-hazards precautions
 - Standard PPE plus airborne precautions plus contact precautions
 - Utilized during the initial phases of an outbreak when the etiology of the infection is unknown or the causative agent is found to be highly contagious (e.g. COVID19)

NOTE: see COVID-19 supplements in addendum section for additional guidelines

Stab Wound

Basic Medical Care

1. Ensure scene safety
2. [Trauma Initial Assessment Protocol](#) or [Pediatric Trauma Assessment Protocol](#)
 - A. If patient found apneic and pulseless without signs of life on arrival, pronounce dead on scene
 - B. For patient noted at any time to have palpable pulses or signs of life, continue resuscitation
 - C. For patient becomes pulseless and apneic and transport time to trauma center is < 15 minutes, continue resuscitation and transport
 - D. For patient becomes pulseless and apneic and transport time to trauma center is > 15 minutes, contact medical control
 - E. Transport should be expedited vs. performing resuscitation efforts on scene (traumatic arrest requires expedited transport to a trauma center in contrast to medical arrests)
3. Maintain airway; suction as needed
4. Assess vital signs
5. Provide supplemental oxygen per patient condition to maintain SpO₂ = 94 – 97%
6. Control any active external bleeding with direct pressure
 - A. Apply MEDIC tourniquet for presumed life-threatening extremity hemorrhage not controllable with direct pressure
7. For penetrating injury noted to the chest or back apply chest seal device
8. For suspected trauma to head or spine, protect and maintain control of the cervical spine, (with manual motion restriction), and the thoracolumbar spine until cervical collar placed and patient secured to the transport stretcher
 - A. Assess neurological status before and after motion restriction
 - B. Patients with isolated penetrating trauma who are neurologically intact do not require cervical collar and spinal immobilization
9. Provide assisted ventilations with bag-valve mask and 100% oxygen if breathing or ventilatory compromise is apparent
10. For penetrating injury noted to chest or back such that the possibility of a tension pneumothorax exists, and the patient is hemodynamically unstable
 - A. "Burp" chest seal device if previously placed
11. Remove appropriate clothing to fully inspect extremities, chest, and abdomen for any significant injuries

Advanced Medical Care

1. IVF as per patient condition
 - A. Adults:
 - i. Hemodynamically unstable: IVF wide open
 - ii. Hemodynamically stable: TKO
 - B. Pediatrics
 - i. Hemodynamically unstable: 10 – 20 ml/kg bolus and reassess
 - ii. Hemodynamically stable: TKO
2. Fentanyl for pain control
 - A. Adults:
 - i. 1 – 2 mcg/kg IN (maximum 200 mcg)
 - ii. 0.5 – 1 mcg/kg IV, IM (maximum 100 mcg)
 - iii. May repeat x1 in 15 minutes as indicated (maximum 100 mcg any route)
 - B. Pediatrics:
 - i. 0.5 – 1 mcg/kg IV, IM, IN (maximum 100 mcg)
 - ii. Contact Medical Control for repeat dosing
3. Alternative analgesic: nitrous oxide via patient-controlled inhalation
 - A. Contraindicated for suspected pneumothorax
4. Advanced Airway management as indicated
 - A. [Airway: Intubation Protocol](#)
 - B. [Airway: BIAD Protocol](#)
5. Ensure proper tube placement using capnometry, SpO₂ and ventilate with 100% oxygen
6. For penetrating injury noted to chest or back such that the possibility of a tension pneumothorax exists, and the patient is hemodynamically unstable
 - A. "Burp" chest seal device if previously placed
 - B. Perform chest needle decompression

Additional Considerations

- * For isolated penetrating wounds: target of fluid resuscitation should be to palpable radial pulse & responsive mental status – not a specific blood pressure measurement
- * Penetrating wounds without ongoing external bleeding should be treated for possible internal hemorrhage
 - Direct pressure should be applied to the entrance site (stab wound to the groin)
- * IV lines should always be initiated in route to destination emergency department
- * The objective for patients sustaining any penetrating injury that results in hemodynamic instability is to arrive at the hospital for definitive care as rapidly as possible from the time that the injury occurred
 - Total scene time should not exceed 10 minutes
- * Patients with isolated penetrating trauma who are neurologically intact do NOT require cervical collar and spinal immobilization
 - Placement onto a long spine board to facilitate patient movement may be beneficial but spinal immobilization with cervical collar is not indicated

Stroke (UP-14)

Stroke Types

- * Thromboembolic (85%)
- * Hemorrhagic (15%)

Differential Diagnosis

- | | |
|---------------------------------|-----------------------------------|
| * Drug ingestion | * Psychiatric |
| * Electrolyte abnormality | * Seizure |
| * Environmental exposure | * Shock |
| * Hypoglycemia | * Transient ischemic attack (TIA) |
| * Hypoxia | * Trauma |
| * Post-ictal (Todd's) paralysis | * Tumor |

Basic Medical Care

1. [Medical Initial Assessment Protocol](#)
2. Maintain airway; suction as needed
3. Assess vital signs
4. Provide supplemental oxygen per patient condition to maintain SpO₂ = 94 – 97%
 - A. Provide assisted ventilations with bag-valve mask and 100% oxygen if breathing or ventilatory compromise is apparent
5. Assess blood glucose level
 - A. Oral glucose for hypoglycemia and patient alert with intact gag reflex
6. Allow all conscious patients to sit in a position of comfort
7. Perform ***Cincinnati Prehospital Stroke Screen***
 - A. Facial Droop
 - Ask patient to smile and show their teeth
 - Normal: Both sides of face move equally
 - Abnormal: One side of face does not move at all
 - B. Arm Drift:
 - Ask patient to hold both arms straight out for 10 seconds
 - Normal: Both arms move equally or not at all
 - Abnormal: One arm drifts compared to the other
 - C. Speech:
 - Ask patient to repeat phrase: *"You can't teach an old dog new tricks"*
 - Normal: Patient uses correct words with no slurring
 - Abnormal: Slurred or inappropriate words or mute
8. Identify time of onset of symptoms
 - A. Note if patient awoke from sleep with symptoms
 - B. If unclear time of onset, note time patient last known to be normal

9. Perform the **Field Assessment Stroke Triage for Emergency Destination (FAST-ED)**

Item	Exam	Score
Facial Palsy		
	Normal/minor	0
	Partial/complete	2
Arm Weakness		
	No drift	0
	Drifts or some effort vs. gravity	1
	No effort vs. gravity/no movement	2
Speech Changes		
	None	0
	Mild to moderate	1
	Severe/aphasia/mute	2
Eye Deviation		
	None	0
	Partial	1
	Forced deviation	2
Denial / neglect		
	None	0
	Extinction to bilateral stimulus	1
	Does not recognize own hand	2

10. Record total FAST-ED score & report to receiving emergency department

Advanced Medical Care

1. Obtain rhythm strip and refer to appropriate protocol as indicated
2. For hypoglycemia treat as per [Diabetic Problems Hypoglycemia Protocol](#)
3. For hyperglycemic treat per [Diabetic Problems Hyperglycemia Protocol](#)
4. For hypertension (SBP > 185 and/or DBP > 110)
 - A. Contact Medical Control for potential labetalol administration 10 – 20 mg IV
5. IVF as per patient condition
 - A. Adults:
 - i. Hemodynamically unstable: IVF bolus – wide open and reassess
 - ii. Hemodynamically stable: TKO
 - B. Pediatrics
 - i. Hemodynamically unstable: 10 – 20 ml/kg bolus and reassess
 - ii. Hemodynamically stable: TKO
6. Ondansetron (Zofran®) for nausea and/or vomiting
 - A. Adults: 4 – 8 mg IV, IM, PO
 - B. Pediatrics: 0.15 mg/kg IV, IM, PO (maximum 4 mg)
7. Advanced Airway management as indicated
 - A. [Airway: Intubation Protocol](#)
 - B. [Airway: BIAD Protocol](#)
8. Ensure proper tube placement using capnometry, SpO₂ and ventilate with 100% oxygen

Additional Considerations

- * CODE STROKE
 - Onset of symptoms < 24 hours
 - 1 or more of the Cincinnati Prehospital Stroke Screen assessments is abnormal
 - 1 of 3 = 72% probability ischemic stroke
 - 3 of 3 = 85% probability ischemic stroke
- * FAST-ED screen is utilized to assist in assessing for a large vessel occlusion (LVO) stroke
 - Local indication for transport to endovascular center (CMC or NHPMC) is FAST-ED score ≥ 6
- * Ischemic strokes are more common in patients greater than 45 years of age
- * Hemorrhagic strokes can be seen in any age group
- * For the patient that cannot provide historical information, it is imperative to obtain as much information as possible from family members or friends prior to scene departure
 - Obtain family member name and contact phone number to provide to receiving hospital personnel
 - Obtain the ***last known normal time*** and report to receiving personnel
- * Acute ischemic strokes typically do not cause seizures, hypotension, or hypoglycemia
 - Seizures are a common presentation for other intracerebral conditions (intracerebral or subarachnoid hemorrhage, tumor, meningitis or other infections, or toxins)
- * Patients with acute stroke symptoms may be candidates for thrombolytic therapy if they arrive at the hospital within 24 hours of symptom onset
 - Do not inform the patient or family members that the patient will receive thrombolytic therapy, as they may not meet inclusion criteria
- * Ensure that the FAST-ED score is communicated to the receiving hospital during pre-arrival radio report

Stroke Transfer tPA Infusion or Post Tenecteplase (AM-6)

Introduction

- * tPA infusion will only be initiated by the referring facility
- * Verify tPA bolus - Amount and time administered
- * Verify tPA total amount to be infused
 - Verify that excess tPA has been withdrawn from the bottle and wasted
 - Time infusion initiated & time infusion to be completed

Advanced Medical Care

1. Apply cardiac monitor with continuous ECG
2. Assess neurologic exam including GCS and pupil exam
 - A. Repeat neurologic exam every 15 minutes throughout transport
3. Obtain baseline set of vital signs and reassess every 15 minutes throughout transport
 - A. Ensure BP evaluated prior to initiation of transport
 - i. SBP < 185 mmHg
 - ii. DBP < 110 mmHg
 - B. All BP readings should be obtained in limb without tPA infusion
4. Labetalol (Normodyne®) 10 mg IV for SBP \geq 185 or DBP \geq 110 and patient not currently receiving antihypertensive infusion & confirm treatment plan with physician
5. For patient on hypertensive medication infusion initiated by referring facility:
 - A. Nicardipine drip (Cardene®) – increase drip 2.5 mg/hour every 15 minutes until SBP < 180, DBP < 105 mmHg or maximum rate of 15 mg/hour
 - B. Labetalol (Normodyne®) drip – increase drip 2 mg/min every 10 minutes until SBP < 180, DBP < 105 mmHg
6. For SBP < 140, DBP < 80 mmHg and antihypertensive agent is infusing STOP infusion of antihypertensive agent
7. Provide supplemental oxygen per patient condition to maintain SpO₂ = 94 – 97%
8. Only stop tPA infusion if any of the following occur (medical control at receiving facility must be notified as soon as possible if infusion is stopped for any reason)
 - A. Allergic reaction
 - B. Excessive bleeding
 - C. Nausea/vomiting
 - D. Onset of severe headache
 - E. Seizure
 - F. Worsening neurological exam
9. It will be necessary to spike the tPA drip chamber into a bag of NS to complete infusion of tPA that is within the IV tubing

Additional Considerations

- * tPA infusion should NOT be stopped simply for transport
- * tPA infusion must NOT be stopped unless one of the above indications for stopping (#8)
- * Review IV pump functioning with referring staff prior to departure as necessary

Traffic Accident (TB-6)

Significant Hemorrhage Considerations

- * External bleeding
- * Femur fracture
- * Hemothorax
- * Intra-abdominal bleeding
- * Pelvis fracture

Life Threatening Injury Considerations

- * Head
 - Airway injury
 - Brain injury
- * Neck
 - Airway injury
 - Spinal cord injury
- * Chest
 - Aortic disruption
 - Cardiac tamponade
 - Flail chest
 - Hemothorax
 - Tension pneumothorax
- * Abdomen
 - Hemorrhage
 - Hollow viscus injury
- * Other
 - External blood loss
 - Hypothermia
 - Pelvic trauma hemorrhage

Basic Medical Care

1. Ensure scene safety
2. [Trauma Initial Assessment Protocol](#) or [Pediatric Trauma Assessment Protocol](#)
3. Assess vital signs
4. Provide supplemental oxygen per patient condition to maintain SpO₂ = 94 – 97%
5. Provide assisted ventilations with bag-valve mask and 100% oxygen if breathing or ventilatory compromise is apparent
6. Control any active bleeding sites with manual direct pressure and/or pressure dressing
 - A. Apply MEDIC tourniquet to any potentially life-threatening hemorrhage unable to be controlled with direct pressure

7. For suspected trauma to head or spine, protect and maintain control of the cervical spine, (with spinal motion restriction) and the thoracolumbar spine until cervical collar placed and patient firmly secured to transport stretcher
 - A. Assess back for additional injuries while log-rolling the patient
 - B. Assess neurological status before and after motion restriction/movement
8. Remove appropriate clothing to fully inspect extremities, chest, and abdomen for any significant injuries
9. Splint any long bone deformities or areas where crush injury has occurred
 - A. Dislocated joints should be splinted in position of deformity
 - B. Fractures should be realigned and splinted from joint above through joint below
 - C. Distal pulses should be assessed before and after realignment and splinting
10. Apply appropriate dressing to any open wounds
11. Assess blood glucose level as indicated per patient presentation

Advanced Medical Care

1. IVF as indicated per patient condition
 - A. Adults:
 - i. Hemodynamically unstable: IVF wide open
 - ii. Hemodynamically stable: TKO
 - B. Pediatrics
 - i. Hemodynamically unstable: 10 – 20 ml/kg bolus and reassess
 - ii. Hemodynamically stable: TKO
2. Fentanyl for pain control
 - A. Adults:
 - i. 1 – 2 mcg/kg IN (maximum 200 mcg)
 - ii. 0.5 – 1 mcg/kg IV, IM (maximum 100 mcg)
 - iii. May repeat x1 in 15 minutes as indicated (maximum 100 mcg any route)
 - B. Pediatrics:
 - i. 0.5 – 1 mcg/kg IV, IM, IN (maximum 100 mcg)
 - ii. Contract Medical Control for repeat dosing
3. Alternative analgesic: nitrous oxide via patient-controlled inhalation
4. Advanced Airway management as indicated
 - A. [Airway: Intubation Protocol](#)
 - B. [Airway: BIAD Protocol](#)
5. Ensure proper tube placement using capnometry, SpO₂ and ventilate with 100% oxygen
6. For injury noted to chest or back such that the possibility of a tension pneumothorax exists, and the patient is hemodynamically unstable:
 - A. Perform chest needle decompression

Additional Considerations

- * For adult with suspected open fracture: cefazolin (Ancef®)
 - > 120 kg: 3 grams IV over 3 – 5 minutes
 - 40 – 120 kg: 2 grams IV over 3 – 5 minutes
- * For pregnant patient
 - Assess gestational age
 - Fundus should be 1 cm above umbilicus for every week >20 weeks
 - Position patient in left lateral position 15 – 30°
 - Crew member may need to manually displace uterus to left side
 - Consider normal hypervolemia that occurs with pregnancy
 - Mother may have lost significant circulating volume and maintain “normal” vitals
 - Fetal perfusion may be greatly reduced even with “normal” vital signs in mother
- * Amputated extremities should be placed in saline soaked dressing in container & container placed on ice as available
- * For unstable pelvic fracture
 - Apply pelvic splint
 - Maintain in place NOT compressed if hemodynamically stable
 - Compress by standard technique if signs of hemorrhagic shock present
- * Glasgow Coma Score
 - Eye opening (1 – 4)
 1. None
 2. Noxious stimuli
 3. Verbal command
 4. Spontaneous
 - Verbal (1 – 5)
 1. None
 2. Incomprehensible
 3. Inappropriate
 4. Disoriented
 5. Oriented
 - Motor (1 – 6)
 1. None
 2. Decerebrate
 3. Decorticate
 4. Withdrawals
 5. Localizes
 6. Follows commands
- * Rule-out medical causes of altered mental status in patients with depressed GCS
 - Hypoglycemia
 - Hypoxemia
 - Overdose

- * Patients should be placed in spinal motion restriction and transported with spinal motion restriction if any of the following are present:
 - Abnormal mental status
 - Intoxicated or under the influence of mind-altering substance
 - Age < 5 years or > 65 years
 - Any posterior midline tenderness
 - Presence of distracting injury
 - Cervical pain with cervical range of motion
 - Patient unable to rotate neck 45 degrees to the left and to the right
 - Do NOT assess range of motion if the patient has any midline cervical spine tenderness to palpation
 - Any focal neurological deficit
 - High risk mechanism of injury
 - ATV crash
 - Ejection from vehicle
 - High speed (>55 mph) or rollover MVC
 - Motorcycle crash
 - Pedestrian or bicyclist struck by motor vehicle
- * If there is any question or uncertainty; the patient should be placed in spinal motion restriction per [Spinal Motion Restriction Protocol](#)
- * Patients who are found ambulatory on scene may have a cervical collar placed and be transported secured firmly to the stretcher in supine position
- * The objective for patients sustaining any blunt or penetrating injury that results in hemodynamic instability is to arrive at the hospital for definitive care within 30 minutes from the time that the injury occurred
- * Unless entrapment/rescue operations occur, total scene time for priority trauma patients should be ≤ 10 minutes
- * IV access should be initiated in route

Traumatic Injury (TB-6)

Introduction

- * Note time of injury
- * Note mechanism of injury
 - MVC: location in vehicle, restraint use, speed of vehicle, impact location, intrusion
 - Fall: distance height of fall, objects impacted, landing surface
 - Ground level falls can result in significant injury
 - Assault: objects utilized, location of strikes

Basic Medical Care

1. Ensure scene safety
2. [Trauma Initial Assessment Protocol](#) or [Pediatric Trauma Assessment Protocol](#)
3. Maintain airway; suction as needed
4. Assess vital signs including GCS
5. Provide supplemental oxygen per patient condition to maintain SpO₂ = 94 – 97%
 - A. Maximize supplemental oxygen for GCS ≤ 8 even if SpO₂ > 94%
6. Provide assisted ventilations with bag-valve mask and 100% oxygen if breathing or ventilatory compromise is apparent
7. Control any active bleeding sites with manual direct pressure and/or pressure dressing
 - A. Apply MEDIC tourniquet to any potentially life-threatening hemorrhage that cannot be controlled with direct pressure
8. For suspected trauma to head or spine, protect and maintain control of the cervical spine, (with spinal motion restriction) and the thoracolumbar spine until cervical collar placed and patient firmly secured to transport stretcher
 - A. As indicated assess back for additional injuries by log-rolling the patient
 - B. Assess neurological status before and after motion restriction/movement
9. Remove appropriate clothing to fully inspect extremities, chest, and abdomen for any significant injuries
10. Splint any long bone deformities or areas where crush injury has occurred
 - A. Dislocated joints should be splinted in position of deformity
 - B. Fractures should be realigned and splinted from joint above through joint below
 - C. Distal pulses should be assessed before and after realignment and splinting
11. Apply appropriate dressing to any open wounds
12. Assess blood glucose level as indicated per patient presentation

Glasgow Coma Score					
Eye Opening		Verbal Response		Motor Response	
				Obeys commands	6
		Oriented	5	Localizes	5
Spontaneous	4	Confused	4	Withdrawals	4
To verbal	3	Inappropriate words	3	Decorticate	3
To pain	2	Incoherent sounds	2	Decerebrate	2
None	1	None	1	None	1

13. For a suspected spinal injury related to an athletic event where the patient has a helmet and shoulder pads in place, the following will be performed for motion restriction:
 - A. Helmet and shoulder pads should both be removed, or both remain in place
 - Do not remove one without removing the other
 - May be removed if athletic trainer available to assist in removing and manual stabilization is maintained throughout the removal process
 - If not removed apply manual stabilization without traction to the cervical spine by holding both sides of the helmet
 - B. Gently remove the protective facemask
 - Athletic Trainer may provide tools and assistance to facilitate this process
 - C. If the spine is not in a neutral position, gently realign
 - Immediately terminate the realignment procedure if the patient complains of increased pain, neurologic deficit or any symptom in any form, muscle spasm or resistance is encountered, airway compromise, it becomes physically difficult to realign, or the patient becomes apprehensive
 - D. Place patient on transport stretcher by standard technique, maintaining cervical spine control at all times
 - Long spine board may be utilized to facilitate patient movement to stretcher
14. For suspected spinal injury related to an athletic event where the patient has a helmet, but no shoulder pads are in use, the following will be performed for motion restriction:
 - A. Helmet may be removed if athletic trainer available to assist in removing and manual stabilization is maintained throughout the removal process
 - B. Apply manual stabilization to the cervical spine by holding sides of the helmet
 - C. Gently remove the facemask (athletic trainer may be able to assist with this)
 - D. If helmet not removed, apply padding (blanket or sheets) on long spine board to ensure shoulders and back are raised to maintain neutral position of the spinal column
15. Carefully remove helmet, maintaining cervical spine stabilization if needed for airway compromise or indication for airway intervention occurs
16. Long spine board may be utilized for transition from field to stretcher and should be removed once the patient is placed on the transport stretcher
 - A. Placement on spine board for movement to stretcher may occur via:
 - Carefully logroll patient while maintaining spinal stabilization
 - Carefully lift patient via 6-person lift maintaining spinal stabilization and sliding board underneath patient from feet of patient
 - B. It is essential that the transition of patient to spine board to stretcher and off spine board is coordinated among all providers in attendance

Advanced Medical Care

1. Apply monitor and obtain 4-lead ECG
2. IVF as indicated per patient condition
 - A. Adults:
 - i. Hemodynamically unstable: IVF wide open
 - ii. Hemodynamically stable: TKO
 - B. Pediatrics
 - i. Hemodynamically unstable: 10 – 20 ml/kg bolus and reassess
 - ii. Hemodynamically stable: TKO
3. Fentanyl for pain control
 - A. Adults:
 - i. 1 – 2 mcg/kg IN (maximum 200 mcg)
 - ii. 0.5 – 1 mcg/kg IV, IM (maximum 100 mcg)
 - iii. May repeat x1 in 15 minutes as indicated (maximum 100 mcg any route)
 - B. Pediatrics:
 - i. 0.5 – 1 mcg/kg IV, IM, IN (maximum 100 mcg)
 - ii. Contact Medical Control for repeat dosing
4. Alternative analgesic: nitrous oxide via patient-controlled inhalation
5. Contraindicated with suspected pneumothorax
6. For adult with suspected open fracture: cefazolin (Ancef®)
 - A. > 120 kg: 3 grams IV over 3 – 5 minutes
 - B. 40 – 120 kg: 2 grams IV over 3 – 5 minutes
7. Advanced Airway management as indicated
 - A. [Airway: Intubation Protocol](#)
 - B. [Airway: BIAD Protocol](#)
8. Ensure proper tube placement using capnometry and SpO₂; ventilate with 100% oxygen
9. For injury noted to chest or back such that the possibility of a tension pneumothorax exists, and the patient is hemodynamically unstable:
 - A. Perform chest needle decompression

Additional considerations

- * Consider all possible causes of shock and treat per appropriate protocol
- * Decompensation in pediatrics is often airway related
- * Geriatric patients often occult injuries are more difficult to recognize, and patients can decompensate unexpectedly with little warning
 - Risk of death with trauma increases after age 55
 - SBP < 110 may represent shock / poor perfusion in patients over age 65
- * Shock may be present with a normal blood pressure initially
- * Shock often is present with normal vital signs and may develop insidiously
 - Tachycardia may be the only manifestation
- * Patients may become hypothermic even in warm environments; ensure warmth maintained

Head Trauma (TB-5)

Injury Types

- * Concussion
- * Contusion
- * Epidural hematoma
- * Skull fracture
- * Subdural hematoma
- * Subarachnoid hemorrhage

Glasgow Coma Score

- * Eye opening (1 – 4)
 1. None
 2. Noxious stimuli
 3. Verbal command
 4. Spontaneous
- * Verbal (1 – 5)
 1. None
 2. Incomprehensible
 3. Inappropriate
 4. Disoriented
 5. Oriented
- * Motor (1 – 6)
 1. None
 2. Decerebrate
 3. Decorticate
 4. Withdrawals
 5. Localizes
 6. Follows commands

Advanced Medical Care

1. Maintain high index of suspicion for cervical spine fracture and stabilize as indicated
2. [Airway: Adult](#); [Airway: Pediatric Protocol](#)
 - A. Advanced airway should be considered in patients with GCS \leq 8
 - B. Nasotracheal intubation is contraindicated with severe facial injury or severe closed head injury with concerns for increased ICP
 - C. Assess and document GCS and neurological exam prior to intubation attempt
3. Maximize supplemental oxygen for GCS \leq 8 even if SpO₂ > 94%
4. Ventilate to maintain normal ETCO₂ (35 – 45 mmHg)
5. Hyperventilate only if:
 - A. Rapidly declining neurological status
 - B. Goal of ETCO₂ = 30 mmHg

Blast Injury (TB-1)

Types of Injury

- * Primary
 - Due to pressure wave of the blast
- * Secondary
 - Due to impaled objects thrown by the blast
 - Most common cause of morbidity/mortality
- * Tertiary
 - Due to patient being thrown or falling as a result of the blast

Basic Medical Care

1. Ensure scene safety
2. Additional care as per appropriate protocol
 - A. [Burn – Chemical Protocol](#)
 - B. [Burn – Thermal Protocol](#)
 - C. [Crush Syndrome Protocol](#)
 - D. [GSW Protocol](#)
 - E. [Radiation Incident Protocol](#)
4. Open wounds should be covered with sterile dressing
5. For suspected trauma to head or spine, protect and maintain control of the cervical spine, (with spinal motion restriction) and the thoracolumbar spine until cervical collar placed and patient firmly secured to transport stretcher
 - A. Assess back for additional injuries while log-rolling the patient
 - B. Assess neurological status before and after stabilization/movement
3. Provide supplemental oxygen per patient condition to maintain SpO₂ = 94 – 97%

Advanced Medical Care

1. Continue advanced level care as per appropriate protocol
 - A. [Burn – Chemical Protocol](#)
 - B. [Burn – Thermal Protocol](#)
 - C. [Crush Syndrome Protocol](#)
 - D. [GSW Protocol](#)
 - E. [Radiation Incident Protocol](#)

Additional Considerations

- * Blast Lung
 - Typically occurs with closed spaced or close proximity to explosion
 - Symptoms: respiratory distress, hypoxia
 - May require early advanced airway management; avoid hyperventilation
- * For intentional explosion: there is concern for secondary device; ensure scene safety and ability to safely remove patient from location

Crush Trauma (TB-3)

Basic Medical Care

1. Ensure scene safety
2. Assess vital signs
3. Provide supplemental oxygen per patient condition to maintain SpO₂ = 94 – 97%
4. Control any active bleeding sites with manual direct pressure and/or pressure dressing
 - A. Apply MEDIC tourniquet to any potentially life-threatening hemorrhage that cannot be controlled with direct pressure
5. Assess neurovascular status of affected extremity as access available
6. Open wounds should be covered with sterile dressing
7. For suspected trauma to head or spine, protect and maintain control of the cervical spine, (with spinal motion restriction) and the thoracolumbar spine until cervical collar placed and patient firmly secured to transport stretcher
 - A. Assess back for additional injuries by log-rolling the patient
 - B. Assess neurological status before and after motion restriction/movement
8. Splint any long bone deformities or areas where crush injury has occurred
 - A. Dislocated joints should be splinted in position of deformity
 - B. Fractures should be realigned and splinted from joint above through joint below
 - C. Distal pulses should be assessed before and after realignment and splinting



Advanced Medical Care

1. IVF as indicated per patient condition
 - A. Adults:
 - i. Hemodynamically unstable: IVF wide open
 - ii. Hemodynamically stable: TKO
 - B. Pediatrics
 - i. Hemodynamically unstable: 10 – 20 ml/kg bolus and reassess
 - ii. Hemodynamically stable: TKO
2. For anticipated prolonged entrapment sodium bicarbonate
 - A. Adults = 50 mEq (50 ml) IV, IO with IVF initiation
 - B. Pediatrics = 1 mEq/kg (1 ml/kg) IV, IO with IVF initiation (max 50 mEq; 50 ml)
3. Immediately prior to extrication sodium bicarbonate
 - A. Adults = 50 mEq (50 ml) IV, IO
 - B. Pediatrics: 1 mEq/kg (1 ml/kg) maximum 50 mEq (50 ml) IV, IO
4. Fentanyl for pain control
 - A. Adults:
 - i. 1 – 2 mcg/kg IN (maximum 200 mcg)
 - ii. 0.5 – 1 mcg/kg IV, IM (maximum 100 mcg)
 - iii. May repeat x1 in 15 minutes as indicated (maximum 100 mcg any route)
 - B. Pediatrics:
 - i. 0.5 – 1 mcg/kg IV, IM, IN (maximum 100 mcg)
 - ii. Contact Medical Control for repeat dosing

5. Alternative analgesic: nitrous oxide via patient-controlled inhalation
6. 12-lead ECG as indicated and access available to evaluate for hyperkalemia
7. For signs of hyperkalemia (see below)
 - A. Calcium gluconate (10% solution)
 - i. Adults = 2 grams (20 ml) IV, IO over 2 minutes
 - ii. Pediatrics = 20 mg/kg IO, IV (0.2 ml/kg); maximum 2 grams (20 ml)
 - B. Sodium bicarbonate 1 mEq/kg (maximum 50 mEq) IV, IO
 - C. Albuterol via nebulizer
 - i. Adults: 5 mg
 - ii. Pediatrics: 2.5 – 5 mg
8. Alternative analgesic: nitrous oxide via patient-controlled inhalation
 - A. Contraindicated with suspected pneumothorax
9. For adult with suspected open fracture: cefazolin (Ancef®)
 - A. > 120 kg: 3 grams IV over 3 – 5 minutes
 - B. 40 – 120 kg: 2 grams IV over 3 – 5 minutes

Additional Considerations

- * Hyperkalemia from crush syndrome can produce ECG changes:
 - Peaked T-waves
 - Wide complex
 - Bradycardia
 - Loss of P-wave
 - Heart blocks

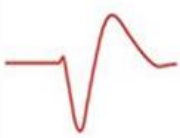
Serum Potassium	Typical ECG Appearance	Possible ECG Abnormalities
Mild (5.5-6.5 mEq/L)		Peaked T waves Prolonged PR segment
Moderate (6.5-8.0 mEq/L)		Loss of P wave Prolonged QRS complex ST-segment elevation Ectopic beats and escape rhythms
Severe (> 8.0 mEq/L)		Progressive widening of QRS complex Sine wave Ventricular fibrillation Asystole Axis deviations Bundle branch blocks Fascicular blocks

Extremity Trauma (TB-4)

Basic Medical Care

1. Ensure scene safety
2. [Trauma Initial Assessment Protocol](#) or [Pediatric Trauma Assessment Protocol](#)
3. Assess vital signs
4. Provide supplemental oxygen per patient condition to maintain SpO₂ = 94 – 97%
5. Control bleeding with direct pressure
 - A. Apply MEDIC tourniquet for potential life-threatening hemorrhage cannot otherwise be controlled per [Wound Care – Tourniquet Protocol](#)
6. For suspected trauma to head or spine, protect and maintain control of the cervical spine, (with spinal motion restriction) and the thoracolumbar spine until cervical collar placed and patient firmly secured to transport stretcher
 - A. Assess back for additional injuries by log-rolling the patient
 - B. Assess neurological status before and after motion restriction/movement
7. Remove appropriate clothing to fully inspect extremities, chest, and abdomen for any significant injuries
8. Splint any long bone deformities or areas where crush injury has occurred
 - A. Dislocated joints should be splinted in position of deformity
 - B. Fractures should be realigned and splinted from joint above through joint below
 - C. Distal pulses should be assessed before and after realignment and splinting
9. Apply appropriate dressing to any open wounds
10. Assess neurovascular status of affected extremity
11. Compare injured extremity to unaffected extremity
12. Exposed bone should be covered with sterile saline dressing
13. Assess for signs of compartment syndrome
 - A. Pain out of proportion to injury
 - B. Pain with passive stretching of muscle groups in compartment
 - C. Paresthesia
 - D. Paralysis (late sign)
 - E. Pulselessness (late sign)

Advanced Medical Care

1. Make all efforts to obtain IV access in uninjured extremity as available
2. Fentanyl for pain control
 - A. Adults:
 - i. 1 – 2 mcg/kg IN (maximum 200 mcg)
 - ii. 0.5 – 1 mcg/kg IV, IM (maximum 100 mcg)
 - iii. May repeat x1 in 15 minutes as indicated (maximum 100 mcg any route)
 - B. Pediatrics:
 - i. 0.5 – 1 mcg/kg IV, IM, IN (maximum 100 mcg)
 - ii. Contact Medical Control for repeat dosing
3. Alternative analgesic: nitrous oxide via patient-controlled inhalation

Impalement Injury

Basic Medical Care

1. Ensure scene safety
2. Assess vital signs
3. Provide supplemental oxygen per patient condition to maintain SpO₂ = 94 – 97%
4. Stabilize impaled object in position to limit any movement during transport
 - A. Splint affected extremity
 - B. In rare instances where removal of the foreign body is necessary – object is compromising the patient’s ability to maintain an airway, or the performance of CPR – an attempt may be made at careful FB removal
 - C. Effort should be made to cut impaled objects which are immovable from their source location just above the entry point to facilitate transport
 - D. Reassess neurovascular status of affected extremity after any impact of impaled foreign body
5. Impalement injuries involving the eye should be stabilized and both eyes patched (affected eye patched with metal eye shield – no direct pressure to the globe)
6. Transport patient in position that does not place any impact on the impaled object
7. Contact Medical Control if unable to transport patient with the impaled object in place
8. Contact Medical Control if unable to remove the impaled object from its source location

Advanced Medical Care

1. IVF as indicated per patient condition
 - A. Adults:
 - i. Hemodynamically unstable: IVF wide open
 - ii. Hemodynamically stable: TKO
 - B. Pediatrics
 - i. Hemodynamically unstable: 10 – 20 ml/kg bolus and reassess
 - ii. Hemodynamically stable: TKO
2. Fentanyl for pain control
 - A. Adults:
 - i. 1 – 2 mcg/kg IN (maximum 200 mcg)
 - ii. 0.5 – 1 mcg/kg IV, IM (maximum 100 mcg)
 - iii. May repeat x1 in 15 minutes as indicated (maximum 100 mcg any route)
 - B. Pediatrics:
 - i. 0.5 – 1 mcg/kg IV, IM, IN (maximum 100 mcg)
 - ii. Contact Medical Control for repeat dosing
3. Alternative analgesic: nitrous oxide via patient-controlled inhalation
 - A. Contraindicated with suspected pneumothorax
4. For adult with suspected open fracture: cefazolin (Ancef®)
 - A. > 120 kg: 3 grams IV over 3 – 5 minutes
 - B. 40 – 120 kg: 2 grams IV over 3 – 5 minutes

Additional Considerations

- * Amputated extremities should be placed in saline soaked dressing in container & container placed on ice as available (do not place amputated part directly on ice)
 - Splint partial amputations in normal alignment without applying tension to soft tissue
 - Apply sterile saline dressing to amputated part
- * Rule-out medical causes of altered mental status in patients with depressed GCS
 - Hypoglycemia
 - Hypoxemia
- * Differential diagnosis of shock in trauma
 - Aortic transection
 - Cardiac tamponade
 - Hemorrhage
 - Myocardial contusion / myocardial infarction
 - Spinal cord injury
 - Note: traumatic brain injury is NOT a cause of shock
 - Tension pneumothorax
- * Patients should be placed in spinal motion restriction and transported with spinal motion restriction if any of the following are present:
 - Abnormal mental status
 - Intoxicated or under the influence of mind-altering substance
 - Age < 5 years or > 65 years
 - Any posterior midline tenderness
 - Presence of distracting injury
 - Cervical pain with cervical range of motion
 - Patient unable to rotate neck 45 degrees to the left and to the right
 - Do NOT assess range of motion if the patient has any midline cervical spine tenderness to palpation
 - Any focal neurological deficit
 - High risk mechanism of injury
 - ATV crash
 - Ejection from vehicle
 - Fall > 3 feet (5 stairs)
 - High speed (>55 mph) or rollover MVC
 - Pedestrian or bicyclist struck by motor vehicle
 - Diving injury
- * Patients who are found ambulatory on scene may have a cervical collar placed and be transported secured firmly to the stretcher in supine position

Unconscious / Syncope (UP-16)

Differential Diagnosis

- * Adverse medication reaction
- * Cardiac abnormality (MI, CHF)
- * CNS lesion
- * Diabetes related
 - o Hypoglycemia
 - o Hyperglycemia (NKHC, DKA)
- * Drug overdose
- * Dysrhythmia
- * Electrolyte abnormality
- * Environmental
 - o Hyperthermia
 - o Hypothermia
- * Head trauma
- * Hemorrhage
- * Hypotension
- * Hypoxemia
- * Infection
 - o Meningitis
 - o Sepsis
- * Metabolic
 - o Acidosis
 - o Alkalosis
- * Psychiatric disorder
- * Pulmonary embolus
- * Seizure
- * Stroke
- * Thyroid abnormality
- * Toxin Exposure
 - o Alcohol
 - o Carbon monoxide
- * Tumor
- * Vasovagal episode

Basic Medical Care

1. Ensure scene safety
2. [Medical Initial Assessment Protocol](#) or [Pediatric Initial Assessment Protocol](#)
3. [Trauma Initial Assessment Protocol](#) or [Pediatric Trauma Assessment Protocol](#)
4. Maintain airway; suction as needed
5. Assess vital signs
6. Provide supplemental oxygen per patient condition to maintain SpO₂ = 94 – 97%
7. Provide assisted ventilations with bag-valve mask and 100% oxygen if breathing or ventilatory compromise is apparent
8. For suspected trauma to head or spine, protect and maintain control of the cervical spine, (with spinal motion restriction) and the thoracolumbar spine until cervical collar placed and patient firmly secured to transport stretcher
 - A. Assess back for additional injuries by log-rolling the patient
 - B. Assess neurological status before and after motion restriction/movement
9. Assess blood glucose level as indicated per patient presentation
 - A. Oral glucose for hypoglycemia and patient alert with intact gag reflex
11. Naloxone (Narcan[®]) for suspected opioids (narcotics) overdose
 - a. Adult: 1 – 2 mg IN
 - b. Pediatric: 0.01 – 0.1 mg/kg IN (maximum 2 mg)

Advanced Medical Care

1. Apply monitor, obtain 4-lead ECG, and refer to appropriate protocol as indicated
2. 12-lead ECG and refer to appropriate protocol as indicated
3. IVF as indicated per patient condition
 - A. Adults:
 - i. Hemodynamically unstable: IVF wide open
 - ii. Hemodynamically stable: TKO
 - B. Pediatrics
 - i. Hemodynamically unstable: 10 – 20 ml/kg bolus and reassess
 - ii. Hemodynamically stable: TKO
4. For hypoglycemia treat as per [Diabetic Problems Hypoglycemia Protocol](#)
5. For suspected opioids (narcotics) overdose
 - A. Naloxone (Narcan®)
 - i. Adults: 1 – 2 mg IV, IN, IM
 - ii. Pediatrics: 0.01 – 0.1 mg/kg IV, IN, IM (maximum 2 mg)
 - B. May repeat every 5 minutes to maximum of 10 mg
6. Advanced Airway management as indicated
 - A. [Airway: Intubation Protocol](#)
 - B. [Airway: BIAD Protocol](#)
7. Ensure proper tube placement using capnometry, SpO₂ and ventilate with 100% oxygen
8. Additional care protocol as indicated per patient condition/presumptive diagnosis

Additional Considerations

- * Patients > 65 syncope is cardiac until proven otherwise
- * Female patients of child-bearing age consider ectopic pregnancy or other pregnancy related complication
- * Consider pulmonary embolus for unexplained syncope in patient with risk factors for thromboembolic disease
- * Syncope with no preceding symptoms or event may be associated with dysrhythmia
- * Assess for signs and symptoms of trauma if associated or questionable fall with syncope
- * Consider Hazmat exposure and utilize PPE as indicated
 - Multiple causes may be present simultaneously
- * Airway management and ventilatory assistance remains paramount and must be performed while preparing naloxone for administration
- * Naloxone administration may precipitate narcotic withdrawal in patients who chronically abuse narcotics
 - Providers must be prepared to manage acute agitation and/or nausea/vomiting that may result from narcotic withdrawal following naloxone administration
- * Always rule out medical causes prior to determining behavioral condition as cause

ECG Considerations

* Brugada syndrome

- Disorder characterized by syncope and sudden death associated
- Genetic alteration of sodium channels of cardiac action potential
- Most common in people from Asia; 8-10 times more prevalent in men
- Often asymptomatic, but ECG shows ST-segment elevation in leads V1-V3
- Type 1: coved ST elevation > 2mm in > 1 of V₁ – V₃ with negative T-wave
- Type 2: "saddleback" ST elevation > 2mm
- Type 3: morphology as type 1 or 2 but < 2mm

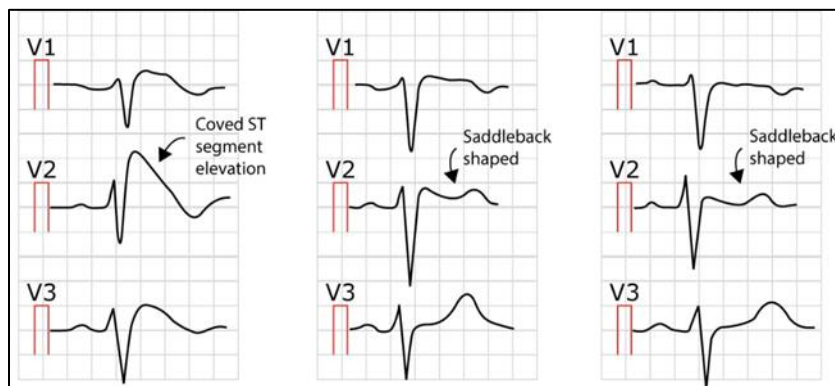

* Long QT Syndrome

- Congenital disorder characterized by a prolongation of the QT interval and a propensity to ventricular tachyarrhythmias, which may lead to syncope, cardiac arrest, or sudden death
- QT interval corrected for heart rate (QTc) that is longer than 0.44 seconds is generally considered to be abnormal, although a normal QTc can be more prolonged in females (up to 0.46sec)
- QT prolongation can lead to polymorphic ventricular tachycardia, or **torsade de pointes**



Unknown Problem

Differential Diagnosis

- | | | |
|----------------------|--------------------|------------------------|
| * Abdominal Pain | * Choking | * Heart Problem |
| * Allergic Reaction | * Convulsions | * Hemorrhage |
| * Behavioral Problem | * Diabetic Problem | * Overdose |
| * Breathing Problem | * General Illness | * Pregnancy/childbirth |
| * Cardiac arrest | * HazMat exposure | * Stroke |
| * Chest Pain | * Headache | * Traumatic Injury |

Basic Medical Care

1. Ensure scene safety
2. [Medical Initial Assessment Protocol](#) or [Pediatric Initial Assessment Protocol](#)
3. [Trauma Initial Assessment Protocol](#) or [Pediatric Trauma Assessment Protocol](#)
4. Maintain airway; suction as needed
5. Assess vital signs
6. Provide supplemental oxygen per patient condition to maintain SpO₂ = 94 – 97%
7. Provide assisted ventilations with bag-valve mask and 100% oxygen if breathing or ventilatory compromise is apparent
8. For suspected trauma to head or spine, protect and maintain control of the cervical spine, (with manual motion restriction) and the thoracolumbar spine until cervical collar placed and patient firmly secured to transport stretcher
 - A. Assess back for additional injuries by log-rolling the patient
 - B. Assess neurological status before and after immobilization/movement
9. Assess blood glucose level as indicated per patient presentation
 - A. Oral glucose for hypoglycemia and patient alert with intact gag reflex

Advanced Medical Care

1. Obtain rhythm strip and refer to appropriate protocol as indicated
2. 12-lead ECG as per patient history
3. IVF as indicated per patient condition
 - A. Adults:
 - i. Hemodynamically unstable: IVF wide open
 - ii. Hemodynamically stable: TKO
 - B. Pediatrics
 - i. Hemodynamically unstable: 10 – 20 ml/kg bolus and reassess
 - ii. Hemodynamically stable: TKO
4. Additional care as per appropriate protocol based on patient's presentation
5. Advanced Airway management as indicated
 - A. [Airway: Intubation Protocol](#)
 - B. [Airway: BIAD Protocol](#)
6. Ensure proper tube placement using capnometry, SpO₂ and ventilate with 100% oxygen

Transfer - Interfacility

Basic Medical Care

1. [Universal Patient Care Protocol](#)
2. Maintain airway; suction as needed
3. Assess vital signs
4. Provide supplemental oxygen per patient condition to maintain SpO₂ = 94 – 97%
5. Provide assisted ventilations with bag-valve mask and 100% oxygen if breathing or ventilatory compromise is apparent
6. Perform any transfer orders prescribed by the transferring or accepting facility
 - A. All orders performed must be within the scope of practice for the provider level
 - B. All orders must be recorded on the PCR as per the ordering physician

Advanced Medical Care

1. Obtain 4-lead ECG and refer to appropriate protocol as indicated
2. IVF as indicated per patient condition
 - A. Adults:
 - i. Hemodynamically unstable: IVF wide open
 - ii. Hemodynamically stable: TKO
 - B. Pediatrics
 - i. Hemodynamically unstable: 10 – 20 ml/kg bolus and reassess
 - ii. Hemodynamically stable: TKO
3. Additional care as per appropriate protocol based on patient's presentation
4. Advanced Airway management as indicated
 - A. [Airway: Intubation Protocol](#)
 - B. [Airway: BIAD Protocol](#)
5. Ensure proper tube placement using capnometry, SpO₂ and ventilate with 100% oxygen
6. Perform any transfer orders prescribed by the transferring or accepting facility
 - A. All orders performed must be within the scope of practice for a paramedic
 - B. All orders must be recorded on the PCR as per the ordering physician

Additional Considerations

- * Confirm destination facility prior to departure from referring facility
 - Crew will confer with patient and physician together to confirm patient destination prior to departing referring facility
- * Interhospital (Emergency Department) transfers involve referring and receiving physicians and facilities and therefore destination is NOT based on Mecklenburg EMS Agency destination protocol
 - Destination is based on the physician (facility) to physician (facility) transfer
 - MEDIC personnel shall NEVER suggest an alternative destination
 - If the patient changes their destination decision after departing the hospital/ED contact must be made with that facility immediately, to inform them of the patient's requested change
- * If patient decompensates while enroute to a destination facility other than an emergency department; consider diverting to the closest emergency department for patient stabilization as indicated regardless of original orders received
 - Contact medical control for clarification
- * Medications on continuous infusion requiring titration during transport will require a nurse to accompany the transport
 - Exceptions are nitroglycerin, dopamine, and lidocaine drips
- * Medications on continuous infusion that do not require titration during transport may be transported provided all the following conditions are met:
 - Medication is on the NCMB approved list for Paramedic personnel
 - Paramedic is familiar & comfortable with the medication and the order
 - Medication infusion is such that, should pump failure occur, the infusion can be stopped without detriment to the patient
- * Medication orders received from the referring physician for single bolus dosing may be followed provided all the following conditions are met:
 - Medication is on the NCMB approved list for Paramedic personnel
 - Paramedic is familiar & comfortable with the medication and the order(s)
 - Detailed parameters for medication dosage are received from referring physician (for clarification the order must be read back to the physician giving the order and documented in the patient care report)
- * Bedside times during interfacility transfers of CODE STEMI and CODE STROKE patients are as significant as scene times
 - The goal should be < 15 minutes at the referring facility
 - 12-lead ECG does NOT need to be performed by MEDIC prior to transport
- * Medical control may be contacted at any time for clarification or assistance

Gunshot Wound

Basic Medical Care

1. Ensure scene safety
2. [Trauma Initial Assessment Protocol](#) or [Pediatric Trauma Assessment Protocol](#)
 - A. For patient found apneic and pulseless without signs of life on arrival, pronounce dead on scene
 - B. For patient noted at any time to have palpable pulses, continue resuscitation
3. Maintain airway; suction as needed
4. Control any active external bleeding with direct pressure
 - A. Apply MEDIC tourniquet for presumed life-threatening extremity hemorrhage not controlled with direct pressure
5. For suspected trauma to head or spine, protect and maintain control of the cervical spine, (with manual motion restriction) and the thoracolumbar spine until cervical collar placed and patient firmly secured to transport stretcher
 - A. Assess back for additional injuries by log-rolling the patient
 - B. Assess neurological status before and after motion restriction/movement
 - C. Patients with isolated penetrating trauma who are neurologically intact do not require cervical collar and spinal immobilization
6. Assess vital signs
7. Provide supplemental oxygen per patient condition to maintain SpO₂ = 94 – 97%
8. Provide assisted ventilations with bag-valve mask and 100% oxygen if breathing or ventilatory compromise is apparent
9. Remove appropriate clothing to fully inspect extremities, chest, and abdomen for any significant injuries
10. For penetrating injury noted to the chest or back apply chest seal device

Advanced Medical Care

1. Obtain rhythm strip and refer to appropriate protocol as indicated
2. IVF as indicated per patient condition
 - A. Adults:
 - i. Hemodynamically unstable: IVF wide open
 - ii. Hemodynamically stable: TKO
 - B. Pediatrics
 - i. Hemodynamically unstable: 10 – 20 ml/kg bolus and reassess
 - ii. Hemodynamically stable: TKO
3. Fentanyl for pain control
 - A. Adults:
 - i. 1 – 2 mcg/kg IN (maximum 200 mcg)
 - ii. 0.5 – 1 mcg/kg IV, IM (maximum 100 mcg)
 - iii. May repeat x1 in 15 minutes as indicated (maximum 100 mcg any route)
 - B. Pediatrics:
 - i. 0.5 – 1 mcg/kg IV, IM, IN (maximum 100 mcg)
 - ii. Contact Medical Control for repeat dosing

4. Alternative analgesic: nitrous oxide via patient-controlled inhalation
 - A. Contraindicated with suspected pneumothorax
5. For adult with suspected open fracture: cefazolin (Ancef®)
 - A. > 120 kg: 3 grams IV over 3 – 5 minutes
 - B. 40 – 120 kg: 2 grams IV over 3 – 5 minutes
6. Advanced Airway management as indicated
 - A. [Airway: Intubation Protocol](#)
 - B. [Airway: BIAD Protocol](#)
7. Ensure proper tube placement using capnometry, SpO₂ and ventilate with 100% oxygen
8. For penetrating injury noted to chest or back such that the possibility of a tension pneumothorax exists, and the patient is hemodynamically unstable:
 - A. Perform chest needle decompression

Additional Considerations

- * For isolated penetrating wounds: target of fluid resuscitation should be to palpable radial pulse & responsive mental status – not a specific blood pressure measurement
- * Penetrating wounds without ongoing external bleeding should be treated for possible internal hemorrhage
 - Manual direct pressure should be applied to the entrance site (stab wound to the groin or upper thigh region)
- * IV lines should always be initiated in route to destination emergency department
- * The objective for patients sustaining any penetrating injury that results in hemodynamic instability is to arrive at the hospital for definitive care within 30 minutes from the time that the injury occurred
 - Total scene time should not exceed 10 minutes
- * Patients with isolated penetrating trauma who are neurologically intact do NOT require cervical collar and spinal immobilization
 - Placement onto a long spine board to facilitate patient movement may be beneficial but spinal immobilization with cervical collar is not indicated

Traffic Accident – Pedestrian Struck (TB-6)

Significant Hemorrhage Considerations

- * External bleeding
- * Hemothorax
- * Intra-abdominal bleeding
- * Pelvis fracture
- * Femur fracture

Basic Medical Care

1. Ensure scene safety
2. [Trauma Initial Assessment Protocol](#) or [Pediatric Trauma Assessment Protocol](#)
3. Maintain airway; suction as needed
4. Control any active bleeding sites with manual direct pressure and/or pressure dressing
 - A. Apply MEDIC tourniquet to any potentially life-threatening hemorrhage that cannot be controlled with direct pressure
5. Assess vital signs
6. Provide supplemental oxygen per patient condition to maintain SpO₂ = 94 – 97%
7. Provide assisted ventilations with bag-valve mask and 100% oxygen if breathing or ventilatory compromise is apparent
8. For suspected trauma to head or spine, protect and maintain control of the cervical spine, (with manual motion restriction) and the thoracolumbar spine until cervical collar placed and patient firmly secured to transport stretcher
 - B. Assess back for additional injuries by log-rolling the patient
 - C. Assess neurological status before and after motion restriction/movement
9. Remove appropriate clothing to fully inspect extremities, chest, and abdomen for any significant injuries
10. Splint any long bone deformities or areas where crush injury has occurred
 - D. Dislocated joints should be splinted in position of deformity
 - E. Fractures should be realigned and splinted from joint above through joint below
 - F. Distal pulses should be assessed before and after realignment and splinting
11. Apply appropriate dressing to any open wounds
12. Assess blood glucose level as indicated per patient presentation

Advanced Medical Care

1. Obtain 4-lead ECG and refer to appropriate protocol as indicated
2. IVF as indicated per patient condition
 - A. Adults:
 - i. Hemodynamically unstable: IVF wide open
 - ii. Hemodynamically stable: TKO
 - B. Pediatrics
 - i. Hemodynamically unstable: 10 – 20 ml/kg bolus and reassess
 - ii. Hemodynamically stable: TKO
3. Fentanyl for pain control
 - A. Adults:
 - i. 1 – 2 mcg/kg IN (maximum 200 mcg)
 - ii. 0.5 – 1 mcg/kg IV, IM (maximum 100 mcg)
 - iii. May repeat x1 in 15 minutes as indicated (maximum 100 mcg)
 - B. Pediatrics:
 - i. 0.5 – 1 mcg/kg IV, IM, IN (maximum 100 mcg)
 - ii. Contact Medical Control for repeat dosing
4. Alternative analgesic: nitrous oxide via patient-controlled inhalation
 - A. Contraindicated with suspected pneumothorax
5. For adult with suspected open fracture: cefazolin (Ancef[®])
 - A. > 120 kg: 3 grams IV over 3 – 5 minutes
 - B. 40 – 120 kg: 2 grams IV over 3 – 5 minutes
6. If there is any question or uncertainty; the patient should be placed in spinal motion restriction per [Spinal Motion Restriction Protocol](#)
7. Patients who are found ambulatory on scene may have a cervical collar placed and be transported secured firmly to the stretcher in supine position
8. Advanced Airway management as indicated
 - A. [Airway: Intubation Protocol](#)
 - B. [Airway: BIAD Protocol](#)
9. Ensure proper tube placement using capnometry, SpO₂ and ventilate with 100% oxygen
10. For injury noted to chest or back such that the possibility of a tension pneumothorax exists, and the patient is hemodynamically unstable:
 - A. Perform chest needle decompression

Additional Considerations

- * Patients should be placed in spinal motion restriction and transported with spinal motion restriction if any of the following are present:
 - Abnormal mental status
 - Intoxicated or under the influence of mind-altering substance
 - Age < 5 years or > 65 years
 - Any posterior midline tenderness
 - Presence of distracting injury
 - Cervical pain with cervical range of motion
 - Patient unable to rotate neck 45 degrees to the left and to the right
 - Do NOT assess range of motion if the patient has any midline cervical spine tenderness to palpation
 - Any focal neurological deficit
 - High risk mechanism of injury
 - ATV crash
 - Ejection from vehicle
 - Fall > 3 feet (5 stairs)
 - High speed (>55 mph) or rollover MVC
 - Pedestrian/bicyclist struck by motor vehicle
 - Diving injury
- * If there is any question or uncertainty; the patient should be placed in spinal immobilization per standard technique
- * Patients who are found ambulatory on scene may have a cervical collar placed and be transported secured firmly to the stretcher in supine position
- * Amputated extremities should be placed in saline soaked dressing in container & container placed on ice as available (do not place amputated part directly on ice)
 - Splint partial amputations in normal alignment without applying tension to soft tissue
 - Apply sterile saline dressing to amputated part
- * Rule-out medical causes of altered mental status in patients with depressed GCS
 - Hypoglycemia
 - Hypoxemia
 - Overdose
- * Differential diagnosis of shock in trauma
 - Aortic transection
 - Cardiac tamponade
 - Hemorrhage
 - Myocardial contusion / myocardial infarction
 - Spinal cord injury
 - Note: traumatic brain injury is NOT a cause of shock
 - Tension pneumothorax

*This
Page
Blank*



Section 4

Clinical Procedures

Airway: BIAD i-Gel® (AP-2)

Indications

- * Cardiac Arrest
- * Respiratory failure

Contraindications

- * Responsive patients with an intact gag reflex
- * Patients with known oropharyngeal disease (cancer, infection)
- * Caustic substance ingestion (drain cleaner, lye)

Complications

- * Intra-oral trauma

Equipment

- * Bag-valve device
- * Portable oxygen source
- * i-Gel® tube
- * Orogastric tube
- * Suction unit
- * Stethoscope
- * Support strap
- * Water-soluble lubricant

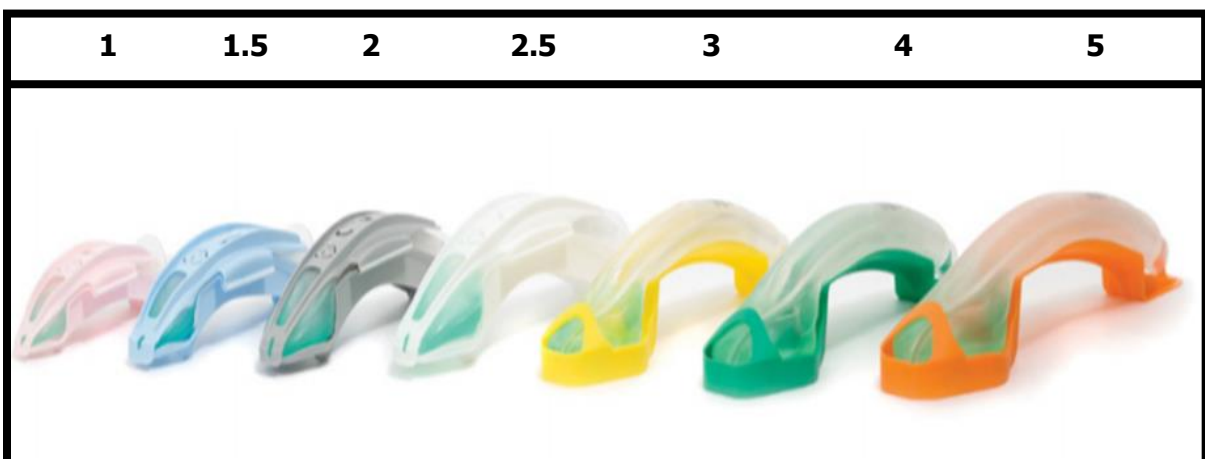

Procedure

1. Select appropriate **tube size based on patient's weight**
 - A. **Size 1 pink** is used in pediatrics between 2 – 5 kg
 - B. **Size 1.5 blue** is used in pediatrics between 5-12 kg
 - C. **Size 2 grey** is used in pediatrics between 10-25 kg
 - D. **Size 2.5 white** is used in pediatrics between 25-35 kg
 - E. **Size 3 yellow** is used in adults between 30 – 60 kg
 - F. **Size 4 green** is used in adults between 50 – 90 kg
 - G. **Size 5 orange** is used in adults > 90 kg
2. Remove the device from the protective cradle & asses for device integrity
3. Place water-soluble lubricant in the middle of the protective cradle
4. Lubricate the back & each side of the i-Gel® cuff
 - A. Avoid placing any lubricant within the bowl of the cuff
5. Position the patient's head
 - A. Neutral position when C-spine precautions are being observed
 - B. "Sniffing" position when no C-spine precautions are required
6. Grasp along the integral bite-block and face the cuff outlet toward the patient's chin
7. Insert the i-Gel® into the mouth in the direction of the hard palate
8. Glide the device down and back along the hard palate with continuous, gentle pressure, until resistance is felt
 - A. Patient's incisors should be at the integral bite-block
9. Attach bag-valve device to the connector and ventilate
10. Confirm proper placement by the following:
 - A. Auscultation of breath sounds
 - B. Absent epigastric sounds
 - C. Assessing pulse oximetry and capnometry
 - D. ETCO₂ waveform or colorimeter color change **MUST** be confirmed
 - E. Rise and fall of chest
11. Measure length of orogastric tube by stretching the tube as follows:
 - A. Tip at xiphoid process
 - B. Stretch up to ear lobe
 - C. Stretch out to mouth
 - D. Hold tube where it hits mouth
12. Lubricate distal end of tube with water-soluble jelly & insert in i-Gel® gastric channel
 - A. This may be done prior to i-Gel® insertion by seating OG-tube in gastric channel (all sizes except size 1) to assist with OG placement
13. Slowly advance tube through port in i-Gel®
14. Advance tube until appropriate depth reached
15. Attach proximal portion of orogastric tube to suction
16. Secure i-Gel® by standard technique using support strap

Additional Considerations

- * For any doubt as to the functioning status of the i-Gel® airway or the position of the device, the i-Gel® airway should immediately be removed

	Pediatric				Adult		
Tube Size	1	1.5	2	2.5	3	4	5
Connector Color	PINK	BLUE	GREY	WHITE	YELLOW	GREEN	ORANGE
Patient Selection	2–5 Kg	5–12 Kg	10–25 Kg	25–35 Kg	30–60 Kg	50–90 Kg	> 90 Kg
Suction Catheter	N/A	10 F	12 F	12 F	12 F	12 F	14 F

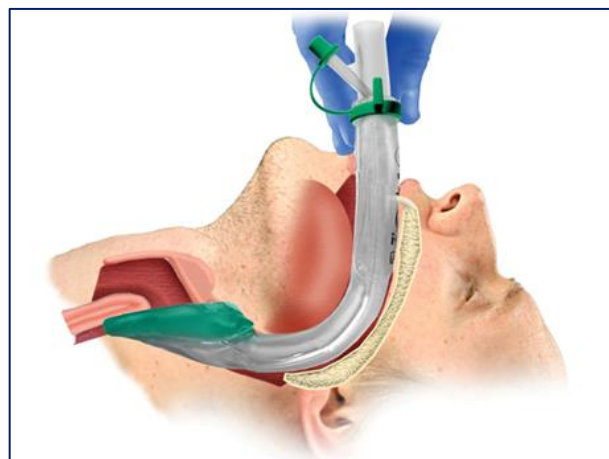

Airway: Intubation Orotracheal (AP-6)

Indications

- * Anticipated clinical course
 - Impending airway compromise
 - Likely deterioration during transport
- * Cardiopulmonary arrest
- * Failure to protect airway
 - Severe head injury with GCS < 8
 - Significantly obtunded with inadequate protection and risk of aspiration
- * Failure to oxygenate or ventilate
- * Injury to upper airway structures with compromised oxygenation / ventilation
- * Profound shock

Contraindications

- * Ability to maintain an adequate airway with adequate oxygenation and ventilation with a less invasive maneuver
- * Patients \leq 14 years of age
 - Utilize BVM or BIAD as patient condition dictates

Complications

- * Bleeding
- * Esophageal placement
- * Fractured teeth
- * Increased intracranial pressure
- * Right mainstem bronchial intubation
- * Trauma
- * Vocal cord injury
- * Vomiting with possible aspiration

Procedure

1. Pre-oxygenate
 - A. Non-rebreather mask @ 15 LPM
 - B. Nasal cannula oxygen @ 10 – 15 LPM – maintain in place throughout the intubation attempt until correct ETT position is confirmed
2. Prepare equipment
 - A. BVM
 - B. Oxygen
 - C. ETT
 - i. Appropriate size plus size smaller & larger available
 - ii. Check bulb
 - iii. Stylet

- D. Laryngoscopes & blades
- E. ETCO₂ detector
- F. Suction
- G. Monitor
 - i. ECG
 - ii. Pulse oximetry
 - iii. ETCO₂ detector
- H. Rescue or difficult airway device (gum elastic bougie, BIAD)
- 3. Hold laryngoscope handle in the left hand and insert extended blade into right corner of the patient's mouth along the lingual surface
- 4. Sweep the tongue to the left with the flange of the blade
- 5. Advance the blade posterior along the tongue
 - A. Advance tip of Mcintosh (curved) blade into vallecula
 - B. Advance tip of Miller (straight) blade posterior to epiglottis
- 6. Lift handle / blade to expose vocal cords
- 7. Pass endotracheal tube through vocal cords via direct visualization
- 8. Remove stylet and inflate ETT cuff
- 9. Verify tube placement
 - A. ETCO₂ detector
 - B. Bilateral breath sounds
 - C. Absent epigastric sounds
- 10. Secure tube position
- 11. Consider post-intubation sedation
- 12. Consider physical restraints for patient safety
- 13. Continuous waveform capnography is required during transport
 - A. Attach a copy of the waveform strip to patients' record

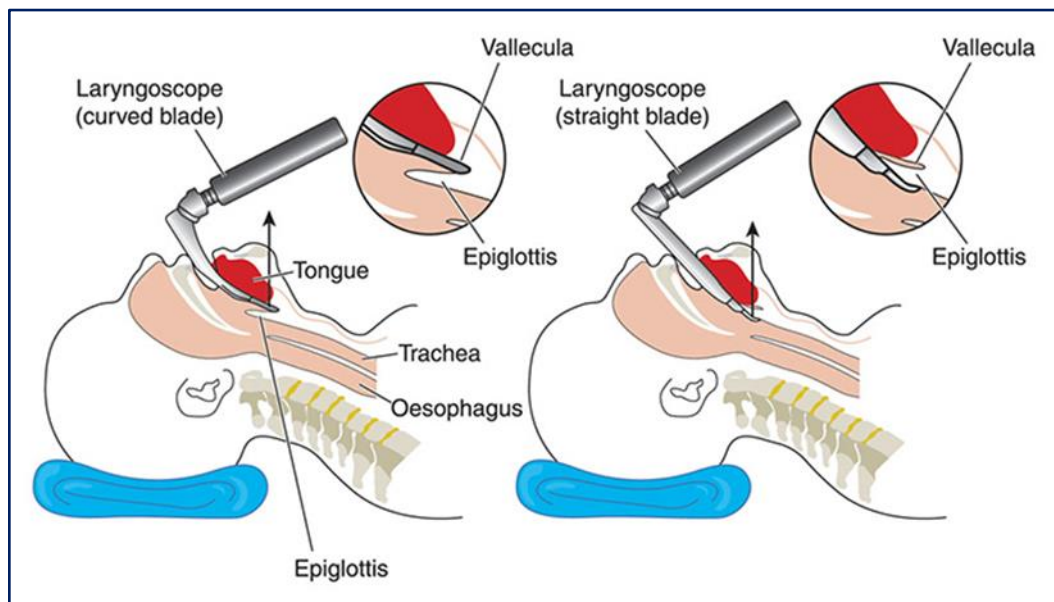

Additional Considerations

- * Individual intubation attempts must be discontinued if patient's SpO₂ < 91%
- * Patient must be supported with BVM with 100% O₂ between intubation attempts
- * It is beneficial to place nasal cannula oxygen at 10 – 15 LPM and maintain usage throughout the intubation attempt until ETT is confirmed in the correct position
- * Movement to a rescue airway device should be made at any time crew member determines that further attempts at intubation would not be successful
- * Confirmation of endotracheal tube placement
 - Capnometry
 - ETCO₂ colorimeter color change may be utilized as initial confirmation
 - Minimum of 6 breaths are required to confirm positive change
 - ETCO₂ continuous waveform must be utilized throughout transport
 - Direct visualization
 - Intubation should only be performed with the ETT is seen passing through the vocal cords
 - Auscultation to confirm bilateral breath sounds
 - Paramedic performing procedure must always assess
 - Auscultation to exclude epigastric breath sounds
 - Pulse oximetry
- * At a minimum each of the following will prompt reassessment of ETT placement:
 - Following movement over rough or difficult terrain in the field
 - Following movement into or removal from the ambulance
- * The attending paramedic will always oversee patient movement procedures
- * Ensure the ETT is secured in place with tape or tie-down twill
- * When the patient is moved into or out of the ambulance, utilize the following procedure:
 - Just prior to movement, the patient will be given one ventilation
 - The bag-valve device will be removed from the endotracheal tube
 - A coordinated movement shall occur with the paramedic's commands
 - Once the stretcher is either secured in the ambulance or secured in the elevated position outside the ambulance, the bag-valve device will be reconnected to the endotracheal tube
 - The patient will be given ventilation
- * The paramedic will repeat an auscultation assessment to confirm tube placement
 - If the assessment is questionable, direct laryngoscopy may be repeated
- * Capnometry and pulse oximetry will be continuous
- * If any doubt as to the correct positioning of the ETT the ETT must be removed

Airway: Intubation Nasal (AP-7)

Introduction

- * Nasotracheal intubation can be done on the awake, breathing patient as an alternative to orotracheal intubation – orotracheal intubation is preferred method in most patients
- * ***Reserved for patients with clear need of ETI and oropharyngeal access is not possible (massive angioedema of tongue/lips)***

Indications

- * Primary method in spontaneously breathing patients in whom orotracheal intubation is not possible but intubation is required (e.g. ACE-Inhibitor angioedema)
- * Alternative to orotracheal intubation in alert patient with impending respiratory failure (CHF, COPD, asthma, pneumonia)

Contraindications

- * Age < 12 years
- * Apnea
- * Coagulopathy / thrombocytopenia
- * Severe head trauma
- * Significant maxillofacial trauma
- * Upper airway obstruction
- * Violent or combative / uncooperative patients

Procedure

1. Preoxygenate with high flow oxygen
2. Place patient in the sniffing position
3. Choose endotracheal size based on the size of the larger nostril
4. Prepare nasal mucosa with lubricating jelly and neosynephrine nasal spray as available
5. Lubricate tracheal end of endotracheal tube
6. Insert tube (without stylet) into nostril with leading edge of bevel away from septum
7. Follow the floor of the nose posterior
8. Advance tube until breath sounds are heard through the tube
9. Gently slide tube through vocal cord into tracheal during patient's inspiration
 - A. Patient may likely cough as tube passes into trachea
10. Inflate tube cuff
11. Confirm placement via auscultation
 - A. ETCO₂ detector
 - B. Bilateral breath sounds
 - C. Absent epigastric sounds
12. Secure tube in place
13. Consider post-intubation sedation
14. Continuous waveform capnography is required during transport
 - A. Attach a copy of the waveform strip to patient's record

Airway: Tracheostomy Tube Change (AP-10)

Indications

- * Obstruction of tracheostomy tube or site that does not clear with suctioning or repositioning
- * Inability to oxygenate/ventilate with no other explanation

Procedure

1. Prepare and check necessary equipment including device of the same size and 0.5 size smaller than patient's existing device
 - A. Have standard airway management equipment available
2. Appropriately lubricate the replacement tube
3. Pre-oxygenate patient
4. Remove patient from mechanical ventilation device and assist with BVD
5. Deflate cuff (if present) on existing device and remove
6. Insert replacement device and verify placement by standard measures including ET CO_2
 - A. Utilize tracheostomy tube obturator as available
7. If unable to place new device, re-attempt replacement with smaller sized device
8. If unable to place new smaller device, use standard airway procedures to assist patient
 - A. [Airway: Adult Protocol](#); [Airway: Pediatric Protocol](#)

Additional Considerations

- * More difficulty with tube changing should be anticipated with tracheostomy sites that are < 2-weeks old
- * Potential complications
 - Airway obstruction
 - Airway device misplacement
 - Bleeding

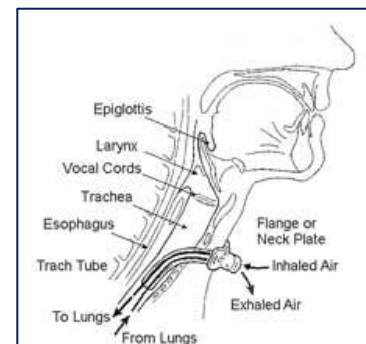
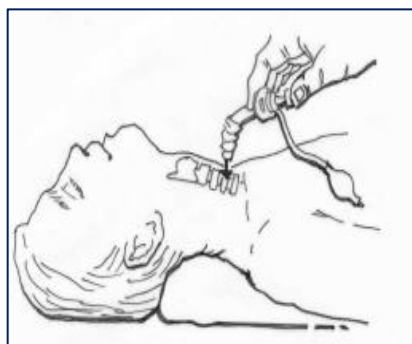
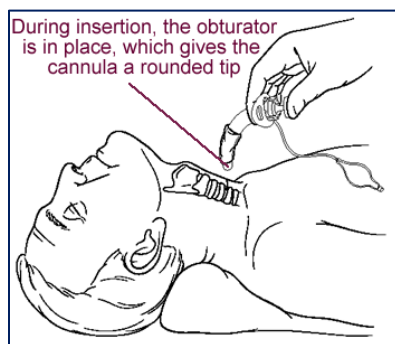

Airway: Endotracheal Tube Introducer (AP-11)

Objective

- * Management of patients with predicted difficult airway intubation
- * Management of patients with failed intubation attempt(s)

Introduction

- * Bougie is a 60 cm long 15F gauge flexible device with a "J" angle at the distal tip
- * For use in patients > 12 years of age
- * Useful with grade 3 or 4 views

Bougie Procedure

1. Position the patient as for standard intubation
2. Insert laryngoscope blade as for airway view
3. Insert tip of the bougie into the trachea and advance, feeling for ridges of tracheal rings
 - A. Tip of bougie should be facing anterior to feel tracheal rings
 - B. Bougie can be advanced until contact with the carina
 - C. If there is no endpoint to advancement of the bougie it is most likely placed in the esophagus and should be removed
4. Thread ETT over the bougie and into the airway
 - A. Keep laryngoscope blade in position to improve ability to pass the ETT into the trachea
5. Advance ETT to standard depth
6. Remove bougie
7. Inflate ETT cuff
8. Ventilate via ETT
9. Confirm placement with standard techniques
10. Secure ETT in place

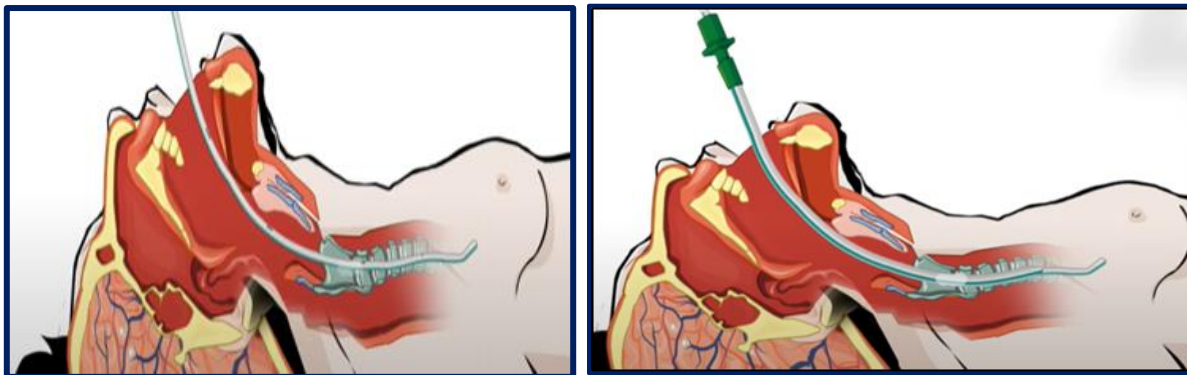

Airway: Intubation Confirmation – ETCO₂ Detector (AP-12)

Indications

- * For confirmation of placement following insertion of any airway device

Procedure

1. MUST be performed on any patient to confirm ETT or BIAD placement
2. Continuous waveform capnography MUST be utilized throughout patient transport to continuously confirm ETT placement
3. Select appropriately sized ETCO₂ detector (*Easy Cap*)
 - A. ≥ 15 kg = adult detector
 - B. < 15 kg = pediatric detector
4. Attach end-tidal CO₂ detector to the end of the airway device (ETT, BIAD)
5. Assess for color change of the ETCO₂ detector (purple → gold)
 - A. At least six ventilations must be performed through the detector to rule-out possibility of false positive color change
6. If appropriate color change does NOT occur the airway device should be removed, and patient assisted with BVM as indicated
7. Continue ventilations through the *Easy Cap* device
 - A. The *Easy Cap* may be used for up to 2 hours duration
8. Once the patient is secured in the transporting vehicle, a continuous in-line ETCO₂ waveform monitor should be placed and continuous waveform capnography monitored throughout the remainder of the transport

Additional Considerations

- * Patients in cardiac arrest may not have CO₂ levels detectable by the *Easy Cap* despite proper placement of the airway device until optimum CPR is performed or adequate cardiac output is re-established
 - Direct visualization may need to be utilized to verify tube position
 - Continuous waveform capnography may be needed to verify tube position

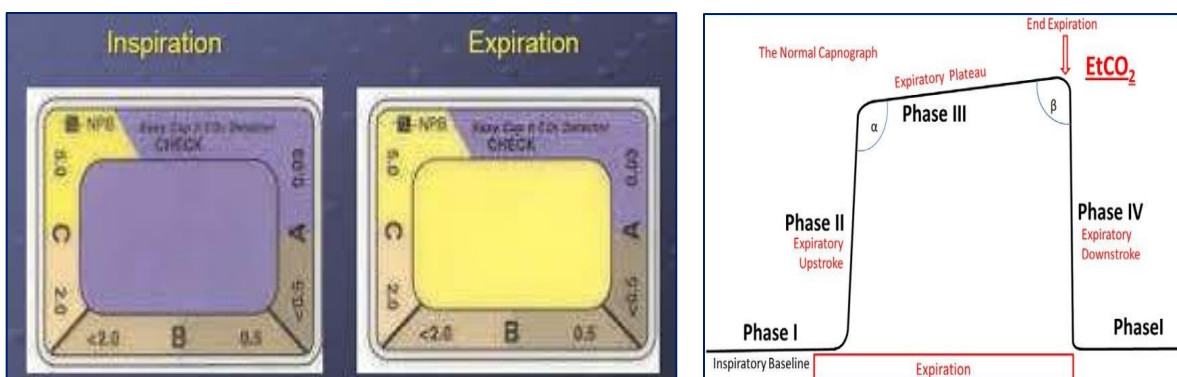

Airway: Foreign Body Obstruction (AP-13)

Procedure

1. Assess degree of airway obstruction by visualization and/or auscultation
2. Do not perform blind finger sweeps in the mouth/oropharynx
3. For infant:
 - A. Deliver five (5) back blows
 - B. If no relief of obstruction, deliver five (5) chest thrusts
 - C. If no relief of obstruction, repeat cycle
4. For child:
 - A. Perform sub diaphragmatic thrusts until obstruction relieved
5. For non-pregnant adult:
 - A. Perform sub diaphragmatic thrusts
 - B. If no relief of obstruction, perform chest thrusts
6. For pregnant adult:
 - A. Perform chest thrusts
7. If patient becomes unresponsive perform direct visualization via direct laryngoscopy and if visible remove foreign body using Magill forceps
8. Initiate CPR / ACLS as indicated by patient condition

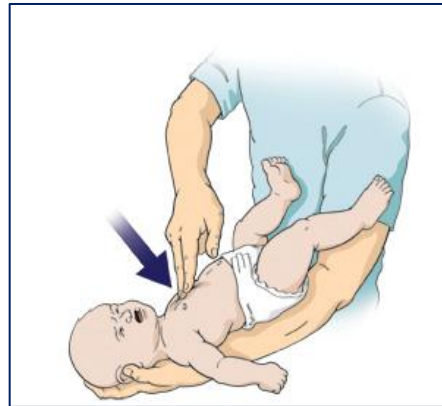

Assessment: Adult (ASP-1)

Airway

1. Assess airway patency
2. Open airway using standard maneuvers (head tilt/chin lift, jaw thrust)
 - A. Utilize jaw thrust maneuver only in patients with potential c-spine injury
3. Insert oral-pharyngeal airway or nasal-pharyngeal airway as indicated
4. Suction as needed to maintain open airway
5. Assess patient's ability to protect airway per [Intubation Protocol](#)

Breathing

1. Assess respiratory effort and rate
2. Assess breath sounds
3. Assess pulse oximetry
4. Supplemental oxygen as indicated (nasal cannula, face-mask, BVM) based on respiratory assessment, SpO₂ as available
5. Place i-Gel[®] as per [BIAD Protocol](#) or intubate as per [Intubation Protocol](#) as condition indicates

Circulation

1. Assess presence and quality of pulses
2. Assess skin color and level of consciousness
3. Obtain baseline vital signs and initiate continuous ECG monitoring
4. Assess need for intravenous access and fluid resuscitation
5. Control major hemorrhage

Disability

1. Assess neurological status
 - A. Assess GCS (record lowest and current) or AVPU level of alertness
 - B. Assess for focal neurological deficits

Additional Considerations

- * Ensure scene size up, scene safety, and universal precautions
- * Patient assessment is to be performed on every patient encounter
- * Assess all applicable vital signs (Temperature, GCS, HR, RR, BP, SpO₂, ETCO₂)
- * Perform focused physical exam based on patient's history and presentation
- * Additional care per appropriate patient care protocol
- * Reassess patient throughout transport
- * Adjust care as patient response to treatment warrants
- * At any point there is a change in the patient's condition restart reassessment

Assessment: Pain (ASP-2)

Indications

- * Assessment of patient's subjective level of pain

Procedure

1. Assess patient's interpretation of his/her pain
2. 0 – 10 numerical scale
 - A. Zero (0) = no pain
 - B. Ten (10) = worst pain ever
3. Wong – Baker faces scale



From Wong D.L., Hockenberry-Eaton M., Wilson D., Winkelstein M.L., Schwartz P.: *Wong's Essentials of Pediatric Nursing*, ed. 6, St. Louis, 2001, p. 1301. Copyrighted by Mosby, Inc

4. FLACC scale
 - A. For use in pre-verbal children or children with cognitive impairment

Category	Scoring		
	0	1	2
Face	No particular expression	Occasional grimace or frown	Frequent quivering chin, clenched jaw
Legs	Normal, relaxed	Restless, uneasy, tense	Kicking, drawn up
Activity	Normal	Squirming, tense, constant shifting	Arched, rigid, jerking
Cry	None	Moans, whimpers	Steadily crying, screams, sobs
Consolability	Content, relaxed	Reassured, distractible	Difficult to console or comfort

5. [Pain Control Protocol](#)
6. Assess patient's response to pain management

Additional Considerations

- * Pain is subjective
- * Measure the patient's perception of his/her pain

Assessment: Pediatric (ASP-3)

Airway

1. Assess airway patency
2. Open airway using standard maneuvers (head tilt/chin lift, jaw thrust)
3. Insert oral-pharyngeal airway or nasal-pharyngeal airway as indicated
4. Suction as needed to maintain open airway
5. Assess patient's ability to protect airway per [Airway: Pediatric Protocol](#)

Breathing

1. Assess respiratory effort and rate
2. Assess breath sounds
3. Assess pulse oximetry
4. Supplemental oxygen as indicated (nasal cannula, face-mask, BVM) based on respiratory assessment, SpO₂ as available
5. Place i-Gel[®] as per [BIAD Protocol](#) as condition indicates

Circulation

1. Assess presence, quality of pulses, and capillary refill
2. Assess skin color and level of consciousness
3. Obtain baseline vital signs and initiate continuous ECG monitoring
4. Assess need for intravenous access and fluid resuscitation

Disability

1. Assess neurological status
 - A. Assess GCS (record lowest and current) or AVPU level of alertness
 - B. Assess for focal neurological deficits

Additional Considerations

- * Scene size up, scene safety, and universal precautions
- * Patient assessment is to be performed on every patient encounter
- * Assess all applicable vital signs (Temperature, GCS, HR, RR, BP, SpO₂, ETCO₂)
- * Utilize Broselow-Luten[®] tape, airway card, or similar system to assist with equipment sizes and medication dosages
- * Perform a focused physical exam based on patient's history
- * At any point there is a change in the patient's condition start reassessment at ABC's
- * Obtain blood glucose level for altered mental status, suspected hypoglycemia, sepsis, seizure, or toxic appearing child

Blood Glucose Analysis (ASP-4)

Indications

- * Need for measurement of blood glucose level
 - Altered mental status
 - Bizarre behavior
 - Diabetes
 - Seizure
 - Unconscious

Contraindications

- * None

Procedure

1. Prepare equipment ensuring QA has been performed on glucometer
 - A. Alcohol pad
 - B. Glucometer
 - C. Lancet
 - D. Reagent test strip
2. Cleanse the anterolateral aspect of the digit with alcohol
3. Obtain blood sample via standard lancet technique
4. Place blood on reagent test strip and place test strip into glucometer
5. Assess glucometer measurement
6. [Diabetic Problems Protocol](#) as indicated by glucose measurement
7. Repeat as necessary based on patient's condition

Additional Considerations

- * "E" Codes
 - E-1 = damaged test strip or incorrect code key
 - E-2 = incorrect code key
 - E-3 = glucose level extremely high or test strip/meter error
 - E-4 = not enough blood
 - E-5 = code key from expired test strips
 - E-6 = blood applied to test strip before flashing blood drop symbol appeared
 - E-7 = electronic error
 - E-8 = temperature above or below proper range for the system
 - E-9 = low battery
 - E-10 = date/time settings incorrect

Capnography (ASP-5)

Indications

- * All patients being ventilated with an advanced airway device in place (ETT, BIAD)
- * All patients with chemical sedation administered

Procedure

1. Prepare equipment
2. Attach in-line ETCO₂ monitor to device and monitor
3. Ensure ETCO₂ waveform is displayed on monitor
4. Attach strip of ETCO₂ waveform from the monitor with the PCR

Additional Considerations

- * Any change in the ETCO₂ waveform mandates a need to immediately re-assess airway device and confirm position
- * Normal ETCO₂ = 35 – 45 mm Hg
- * Normal waveform:

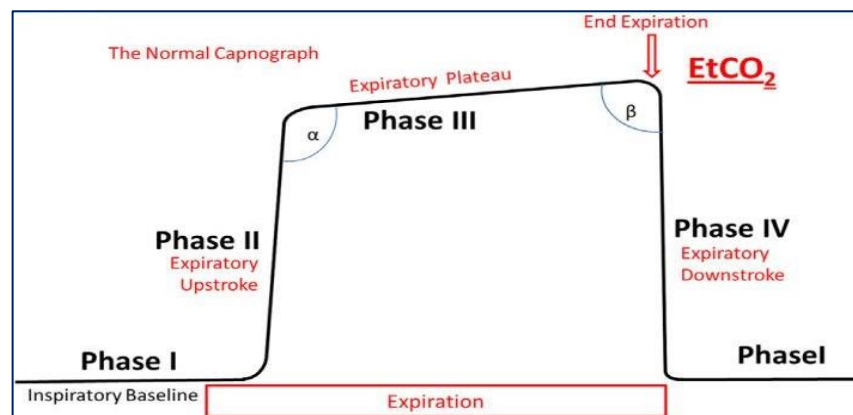
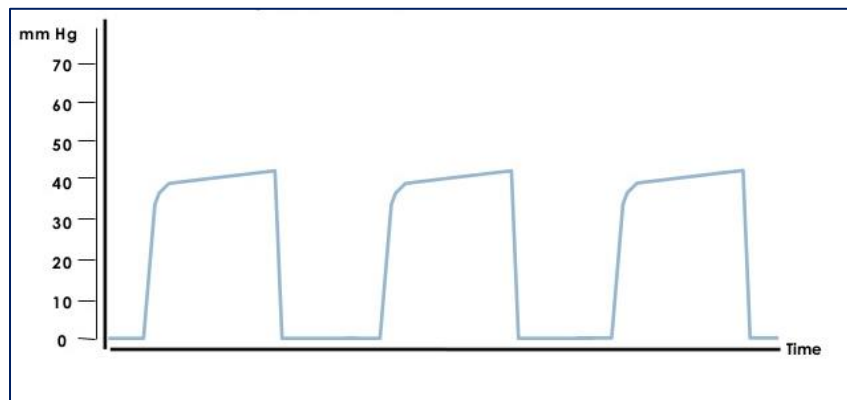

- * ETCO₂ waveforms
 - Normal

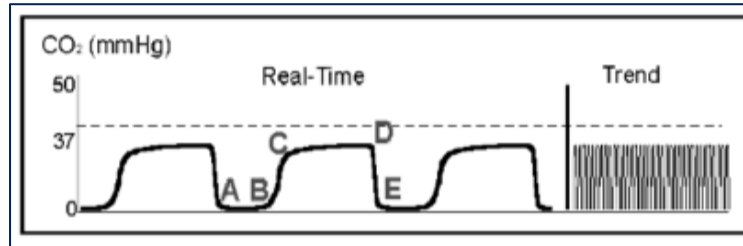

- ETT placed in esophagus

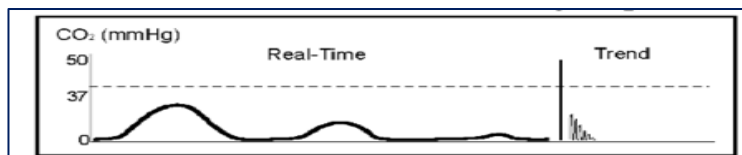

Possible Causes:

- Missed intubation
- A normal capnogram is the best evidence that the ET tube is correctly positioned
- With ET tube in the esophagus, little or no CO₂ is present

- Hypoventilation

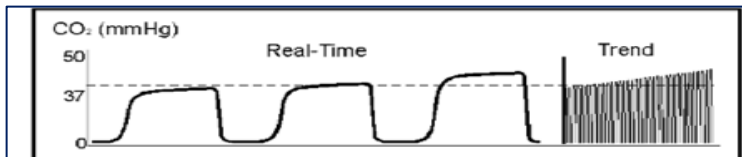

Possible Causes:

- Decrease in respiratory rate
- Decrease in tidal volume
- Increase in metabolic rate

- Hyperventilation

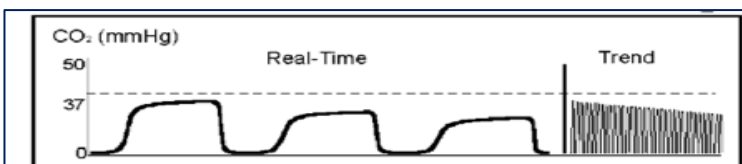

Possible Causes:

- Increase in respiratory rate
- Increase in tidal volume
- Decrease in metabolic rate

- * Patients in cardiac arrest, a sudden increase in ETCO₂ may indicate ROSC
- * ETCO₂ must be documented in PCR

Pulse Oximetry (ASP-6)

Indications

- * Need to assess patient's oxygen saturation
- * Included in standard set of initial vital signs
- * All intubated patients
- * All patients receiving chemical sedation

Procedure

1. Prepare equipment
2. Attach pulse oximetry sensor to patient's finger in standard fashion
3. Assess oximetry measurement
 - A. Verify pulse rate per SpO₂ monitor with patient's palpated pulse rate
4. Further treatment per appropriate patient condition protocol

Additional Considerations

- * Factors which may adversely affect pulse oximetry readings
 - Poor peripheral circulation
 - Hypotension
 - Hypothermia
 - Fingernail polish
 - Ambient light
 - Irregular cardiac rhythms
 - Carbon monoxide
 - May give false oxygen saturation level as oximetry is unable to determine hemoglobin saturated with CO vs. O₂
- * Use the pulse oximetry as an added tool for patient evaluation
 - Treat the patient, not just the data provided by the device
 - SpO₂ reading should never be used to withhold oxygen from a patient in distress
- * Supplemental oxygen is not indicated if the SpO₂ is $\geq 94\%$, unless there are obvious signs of heart failure, significant dyspnea, or hypoxia in order to maintain SpO₂ 94%

Stroke Screen: Cincinnati Prehospital (ASP-8)

Facial Droop:

- * Ask patient to smile and show their teeth
 - Normal: Both sides of face move equally
 - Abnormal: One side of face does not move at all

Arm Drift:

- * Ask patient to hold both arms straight out for 10 seconds
 - Normal: Both arms move equally or not at all
 - Abnormal: One arm drifts compared to the other

Speech:

- * Ask patient to repeat phrase: *"You can't teach an old dog new tricks"*
 - Normal: Patient uses correct words with no slurring
 - Abnormal: Slurred or inappropriate words or mute

Code Stroke

- * Less than 24 hours from symptoms onset

Temperature Measurement (ASP-9)

Indications

- * Need for temperature measurement

Procedure

1. Place thermometer probe in standard fashion with appropriate probe cover utilized
2. Exergen® Temporal Thermometer
 - A. Gently position the probe flush (flat) on the center of the forehead, midway between the eyebrow and the hairline
 - B. Press and hold the SCAN button
 - C. Lightly slide the thermometer across the forehead keeping the sensor flat and in contact with the skin until you reach the hairline
 - A. Lift probe from forehead and touch on neck just behind the ear lobe
 - B. Release the SCAN button and remove the thermometer from the head
 - C. Read the temperature on the display
 - D. Document the temperature in the vitals section of the PCR
3. Assess thermometer reading
4. Further care per appropriate protocol
 - A. [Fever Protocol](#)
 - B. [Heat / Cold Exposure Protocol](#)
5. Reassess as indicated by patient condition

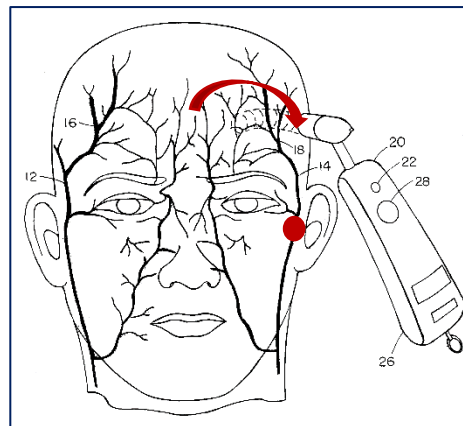

Orthostatic Blood Pressure Measurement (ASP-10)

Indications

- * Need to further assess potential for significant intravascular volume depletion
- * History of syncope potentially related to volume depletion

Contraindications

- * Patient unable to stand or cooperate with procedure
- * Altered mental status
- * Suspect pelvic, lower extremity fracture, or need for spinal motion restriction
- * Hypotension in supine position

Procedure

1. Obtain heart rate and blood pressure with the patient in the supine position
2. Patient should stand for two (2) minutes
3. Obtain heart rate and blood pressure with the patient standing
4. Positive results
 - A. Patient becomes symptomatic (lightheaded, dizzy, near-syncope)
 - B. 30 BPM rise in heart rate
5. For positive refer to appropriate protocol based on cause of volume depletion

Additional Considerations

- * If patient becomes symptomatic or significantly tachycardic at any time, immediately return patient to supine position

Verbal De-escalation (ASP-11)

- * Demonstrate respect of patient's personal space
 - Maintain about 6 feet of distance and do not position yourself between the patient and only exit
 - Both you and patient should be able to exit the room without feeling blocked-in
- * Do not provoke patient during interaction
 - Body language must convey that you want to listen and you do not want to inflict harm
 - Your hands should be visible and open
 - Do not face the patient head-on (always stand at an angle)
 - Avoid prolonged staring or direct eye contact
 - Make sure others are not provoking the patient (providers, family members, bystanders)
- * Establishes rapport
 - Introduce yourself and explain your role
 - Multiple providers talking to the patient will create confusion and may escalate patient's behavior
 - Emphasize you are there to keep the patient safe
 - Ask the patient their name and how they want to be addressed
- * Use concise statements when talking
 - Agitation creates problems in a patient's ability to process information
 - Keep your conversation simple and short, allowing time for patient to process information
 - Repeat your statements, requests, or commands to ensure understanding
 - You may need to repeat 2 – 12 times before patient understands
- * Identify wants, feelings, and stress causing the crisis
 - "When you called 911, how did you think we could help you?"
 - "I would like to know what caused you to become upset today so we can help you"
 - Identifying a need can help to quickly de-escalate the situation
- * Listen closely to patient
 - You should be able to repeat back what is said by the patient
 - "Tell me if I have all this right"
 - "Let me make sure I understand what you said"
- * Agree or agree to disagree
 - If statements are truthful, then agree with the truth
 - Agree in principle, maybe patient's statement is not true, but you can agree, that in general, the idea is true
 - Agree with the odds, anyone may be upset by the same circumstances
 - Do not agree with delusions, at that point you can agree to disagree
- * Set clear limits on acceptable behavior
 - Set limits in a positive, matter-of-fact manner, and not in a threatening manner
 - Inform the patient that harm to self or other providers will not be tolerated
 - If the patient's behavior is frightening to providers, tell the patient so
 - Remind the patient you are there to help, keep them safe, but providers cannot be abused
- * Offer choices to patient (if available) and remain positive in your interactions
 - Offer choices that are realistic and may provide comfort; drinks, food, blankets, etc.
 - If medication is needed, offer choice between PO and IM/IN/IV, offer medication early in encounter

Zoll X-Series Cardiac Monitor Defibrillator System

Introduction

- * The Zoll X-Series monitor defibrillator cardiac management system consists of a single component for both monitoring and therapy delivery

Functions

- * 4-lead ECG & continuous monitoring
- * 12-lead ECG
- * Non-invasive blood pressure (NiBP)
- * SpO₂ monitoring
- * ETCO₂ monitoring
- * Transmission of information to hospitals

Actions

- * Defibrillation
 - Automated (EMT utilization)
 - Manual (Paramedic utilization)
- * Synchronized cardioversion
- * Transcutaneous pacing
- * CPR feedback

Additional Considerations

- * The device must be taken to the patient on each call
- * For synchronized cardioversion the "sync" button must be pressed for each attempt
- * For transcutaneous pacing the 4-lead cables must be applied to the patient
- * The CO₂ button on the monitor must be pushed for ETCO₂ monitoring
 - Attach ETCO₂ tubing to the monitor; push the CO₂ button, then attach tubing to the airway device
- * Prior to ECG transmission to hospitals enter appropriate patient demographic data to ensure accurate evaluation by ED personnel
 - Run number
 - Patient last name

Zoll X-Series Controls and Indicators



Zoll X-Series Left Side Connection Layout

- * ECG connection
- * SpO₂ connection
- * Non-Invasive BP connection
- * ETCO₂ connection



Additional Considerations

- * The

12-Lead ECG (CSP-1)

Indications

- * Abnormal rhythm noted on 4-lead ECG
- * Electrical injuries
- * Suspected tricyclic antidepressant overdose
- * Symptoms suspected of cardiac etiology
- * Syncope

Contraindications

- * Unstable patient requiring immediate definitive care

Procedure

1. Prepare monitor
2. Apply monitor leads as follows:
 - RA – right arm
 - LA – left arm
 - RL – right leg
 - LL – left leg
 - V1 – 4th intercostal space, right sternal border
 - V2 – 4th intercostal space, left sternal border
 - V3 – ½ way between V2 & V4
 - V4 – 5th intercostal space midclavicular line
 - V5 – level with V4, anterior axillary line
 - V6 – level with V4, mid-axillary line
3. Acquire ECG data and print ECG
4. Review ECG and computer interpretation of ECG
5. Contact medical control for any significant changes in ECG
6. Attach copy of ECG to the PCR

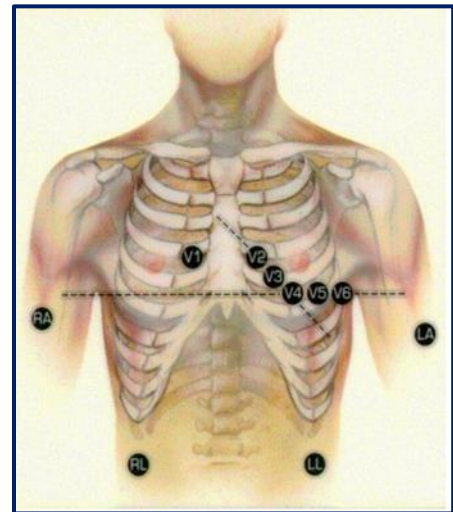

Additional Considerations

- * In patient with potential for STEMI the goal is to obtain 12-lead ECG within 8 minutes of patient contact
- * Patients with 12-lead ECG performed at the referring facility do not require additional ECG by MEDIC unless there is a significant change in the patient's clinical status

Cardiac: Cardioversion (CSP-2)

Indications

- * Unstable tachydysrhythmia

Contraindications

- * Patient is pulseless

Procedure

1. Assess vital signs and continuous ECG rhythm
2. Apply cardioversion pads
 - A. Anterior (-) / Posterior (+)
 - B. Parasternal (-) / Apex (+)
3. Based on patient's hemodynamic status
 - A. Midazolam (Versed®) 5 mg IV, IM or 10 mg IN
 - B. Fentanyl 1 mcg/kg IV, IM, or IN (maximum 100 mcg)
4. Set to synchronized
5. Set energy selection to 50 – 150 Joules based on patient's cardiac rhythm
6. Ensure all personnel are clear from contact with the patient
7. Depress cardioversion button & maintain depressed until shock is delivered
 - A. Note: a synchronized shock may be delayed several cardiac beats as monitor synchronizes to patient rhythm
11. Assess patient's response to cardioversion
12. For persistent dysrhythmia increase energy and attempt cardioversion again
13. Assess patient's response to cardioversion
14. For dysrhythmia persisting, contact medical control
15. If rhythm deteriorates into ventricular fibrillation or pulseless rhythm, immediately follow appropriate protocol for the new dysrhythmia

Additional Considerations

- * Energy levels for cardioversion
 - Atrial fibrillation: 150 Joules (only if verified acute duration [$< 48^{\circ}$] or therapeutic on anticoagulation)
 - Contact medical control prior to attempting cardioversion in a patient who has been in chronic atrial fibrillation ($> 48^{\circ}$) without therapeutic anticoagulation
 - Repeat at 150 Joules as indicated
 - Atrial flutter: 50 joules
 - Repeat at 100 Joules then 150 Joules as indicated
 - AV nodal re-entrant tachycardia: 50 joules
 - Repeat at 100 Joules then 150 Joules as indicated
 - Ventricular tachycardia: 100 joules
 - Repeat at 150 Joules as indicated

Cardiac: External Pacing (CSP-3)

Indications

- * Bradycardias with hemodynamic compromise and unresponsive to initial drug therapy
 - Symptomatic 2°, or 3° AVB
 - Symptomatic sick sinus syndrome
 - Symptomatic idioventricular bradycardia
 - Symptomatic atrial fibrillation with slow ventricular response
 - Bradycardia with malignant ventricular escape rhythms
 - Drug induced bradycardia (beta-blockers, calcium channel blockers...)
 - Permanent pacemaker failure

Contraindications

- * Asystole cardiac arrest
- * Bradycardia secondary to hypothermia

Procedure

1. Assess vital signs and cardiac rhythm
2. Apply pacing pads and limb leads to patient
 - A. Anterior (-) / Posterior (+)
 - B. Parasternal (-) / Apex (+)
3. Based on patient's hemodynamic status
 - A. Midazolam (Versed®) 5 mg IV, IM or 10 mg IN
 - B. Fentanyl 1 mcg/kg IV, IM, or IN (maximum 100 mcg)
4. Set monitor to pacing mode
 - A. Set HR to 80 beats per minute adult, 100 beats per minute child
 - B. Set milliamp to 10 mA and slowly increase milliamp output until electrical capture noted on monitor
5. Check pulse for mechanical capture
 - A. If no mechanical capture, increase milliamp output until mechanical capture achieved
6. Reassess vital signs and patient condition

Additional Considerations

- * Potential symptoms indicating need to initiate external pacing
 - Altered mental status, confusion
 - Chest pain
 - Hypotension
 - Pulmonary edema
- * When pacing in demand mode; if a lead comes off the patient the Zoll will automatically switch to fixed mode pacing at the last set rate and energy
- * Any medication patches (e.g. nitroglycerin, clonidine) should be removed prior to pacer pad application

Cardiac: Cardiopulmonary Resuscitation (CSP-4)

Indication

- * Basic life support for the patient in cardiac arrest
- * Basic life support for neonatal bradycardia

Procedure

1. Assess for pulse, respirations, responsiveness
2. Perform basic airway maneuver to assess for spontaneous respiratory effort
 - A. Perform jaw thrust if concern for potential cervical spine injury
 - B. Place infants in sniffing position
 - C. For pediatric patient provide two (2) ventilations if no respiratory effort
3. Assess continuous ECG monitoring
4. If no pulse and rhythm appropriate for defibrillation:
 - A. EMS witnessed: [Ventricular Fibrillation / Pulseless Ventricular Tachycardia Protocol](#)
 - B. Non-EMS witnessed: initiate chest compressions
5. If no pulse and rhythm not appropriate for defibrillation initiate chest compressions
 - A. Compression rate = 100 – 110/minute
 - i. Infants & children: compress 1/3 – 1/2 depth of the chest
 - ii. Adults: compress 2 inches
6. Reassess pulse/rhythm after 200 compressions
 - A. Provider administering compressions must count aloud every 20th compression delivered
7. Place BIAD or initiate BVM ventilations
 - A. Provide ventilations at a rate of 6/minute
 - i. Provide ventilation as provider administering compressions counts aloud every 20th compression
 - ii. For pediatrics (\leq 14-years) provide one ventilation ever 10th compression
 - B. Ensure hyper- / over- ventilation does NOT occur
 - C. If patient has airway device in place, compressions / breaths do NOT need to be synchronized
8. IVF resuscitation
9. If rhythm changes initiate appropriate new protocol

Additional Considerations

- * Refer to appropriate ACLS protocol based on rhythm noted and patient condition

Cardiac: Defibrillation – Automated (CSP-5)

Indications

- * Non-traumatic cardiac arrest in patients > 1 year of age

Notes

- * Adult pads: \geq 8 years of age or \geq 55 pounds (25 kg)
- * Pediatric pads: < 8 years of age or < 55 pounds (25 kg)

Procedure

1. Confirm cardiac arrest
2. Initiate CPR until Zoll monitor in AED available
3. Expose chest
4. Turn Zoll monitor on and attach AED pads to patient
 - A. Adult
 - i. Inferior to right clavicle
 - ii. Left mid axillary line
 - B. Pediatric
 - i. Anterior chest between nipples
 - ii. Posterior back between scapula
 - iii. Pads must not be touching each other
5. Plug pads into connector
6. Hold CPR and clear the patient for rhythm analysis

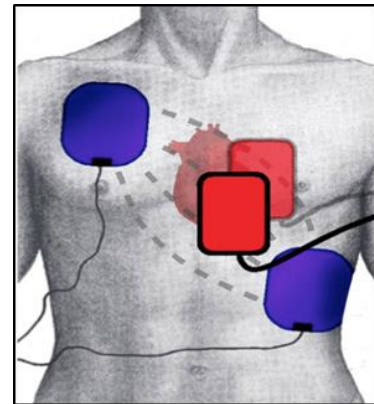

7. Press "Analyze" button
8. Defibrillate if AED mode determines "shock advised"
 - A. Ensure all personnel clear from contact with patient before energy is delivered and depress "shock" button
 - B. If "no shock advised" continue CPR for 200 compressions and disarm the AED
9. Immediately re-establish CPR for 200 compressions; ~ two (2) minutes
10. Assess for pulse
11. For no pulse repeat steps 8 through 9
12. With return of spontaneous circulation initiate [Post Resuscitation Protocol](#)

Cardiac: Defibrillation – Manual (CSP-6)

Indications

- * Ventricular fibrillation or pulseless ventricular tachycardia

Management

1. Initiate CPR until defibrillation available
2. Confirm rhythm on monitor
 - A. EMS witnessed; defibrillate immediately once defibrillator available
 - B. Non-EMS witnessed; perform CPR for 200 compressions prior to defibrillation
3. Attach defibrillation pads
 - A. Adult
 - i. Inferior to right clavicle
 - ii. Left mid axillary line
 - C. Pediatric
 - i. Anterior chest between nipples
 - ii. Posterior back between scapula
 - iii. Pads must not be touching each other
4. Select energy level
 - A. **Ventricular Fibrillation / Pulseless Ventricular Tachycardia Protocol**
5. Charge defibrillator
6. Ensure all personnel clear from contact with patient
7. Press "shock" button to deliver energy to patient
8. Immediately resume CPR
9. CPR for 200 compressions
 - A. Ensure provider performing compressions counts aloud every 20th compression
10. Pre-charge defibrillator at compression #180
11. Reassess pulse and rhythm
12. For no pulse and rhythm requires defibrillation repeat steps 5 through 9

Additional Considerations

- * Any time rhythm changes convert to appropriate ACLS protocol
- * Goal is to perform defibrillation within 6 seconds of pausing CPR

Parenteral Access: Arterial Line Maintenance (PAS-2)

Indications

- * Patient with previously placed arterial line

Procedure

1. Ensure line is secured
2. Assess site for potential complications of insertion
3. Assess distal extremity perfusion
4. Exchange of transducer line should occur at site closest to patient connection
5. Set the transducer at the level of the patient's right atrium
6. Set monitor for monitoring of arterial pressure wave form
7. Verify pressure measurements with manual pressure for question as to accuracy of arterial line measurements

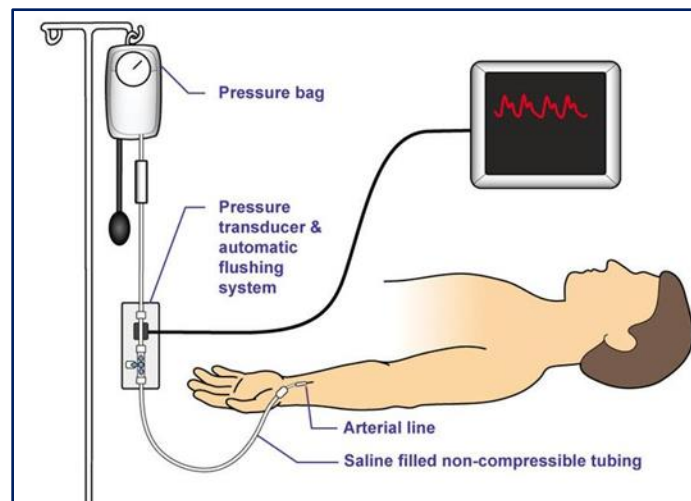

Additional Considerations

- * Do NOT utilize arterial line for administration of fluids or medications

Parenteral Access: Venous Blood Draw (PAS-3)

Clinical Indications

- * Collection of a patient's blood for laboratory analysis

Procedure

1. Prepare equipment
2. Place venous tourniquet on extremity proximal to anticipated site to restrict venous flow
3. Select vein and prep using aseptic technique
4. Select appropriate blood-drawing devices
 - A. Vacutainer holder and needle / butterfly needle
 - B. Syringe and needle / butterfly needle



5. Puncture vein and withdraw blood
6. Draw appropriate tubes of blood for lab testing
7. Release venous tourniquet
8. Withdrawal needle and apply dressing/pressure to puncture site
 - A. Ensure hemostasis at site
9. Assure blood samples are labeled with the correct information
 - A. Patient's name
 - B. Date & time
 - C. Initials of providers collecting blood
10. Deliver the blood tubes to receiving nurse at destination facility

Additional Considerations

- * Patients with an existing peripheral IV may have blood collecting directly from the existing catheter vs. performing an additional puncture
- * Utilize aseptic technique to prep existing catheter adapter
- * Withdraw 5-10 ml of blood and discard syringe
- * Utilize new syringe to collect blood sample to be utilized for testing



Parenteral Access: Central Line Maintenance (PAS-4)

Procedure

1. Assess line entrance site and depth of insertion
2. Ensure the line is secured in place
3. If catheter becomes dysfunctional or becomes dislodged discontinue infusions and contact medical control

Additional Considerations

- * Do not manipulate the catheter during transport
- * Catheter may be utilized for medication and IVF administration if position has been verified by referring physician prior to transport

- * Subclavian Catheter

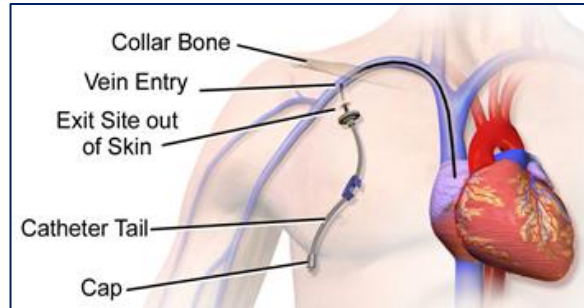

- * Internal Jugular Catheter

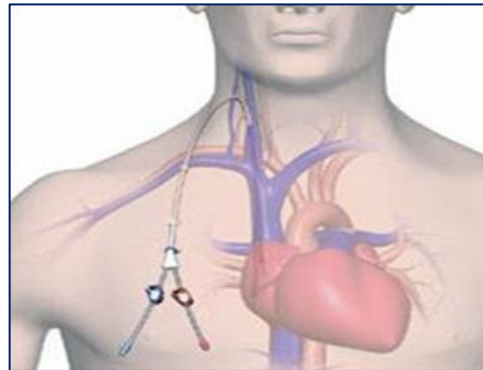

- * Femoral Catheter

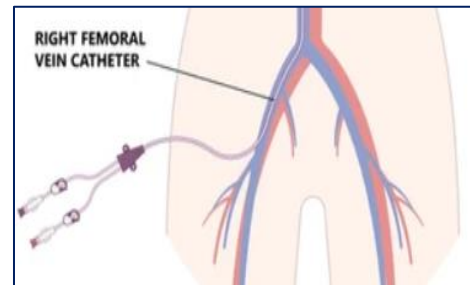

- * PICC

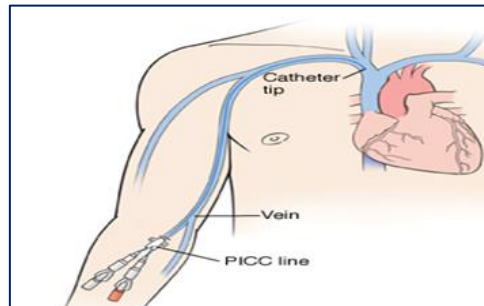

Parenteral Access: Epidural Maintenance (PAS-5)

Procedure

1. Ensure catheter is secured
2. Verify any medication, concentration, and dose of medication infusing
3. Assess catheter for any complications to site or catheter placement

Additional Considerations

- * Do not adjust catheter position
- * Do not adjust medications without consultation with the referring or accepting physician or Medical Control
- * Catheter:

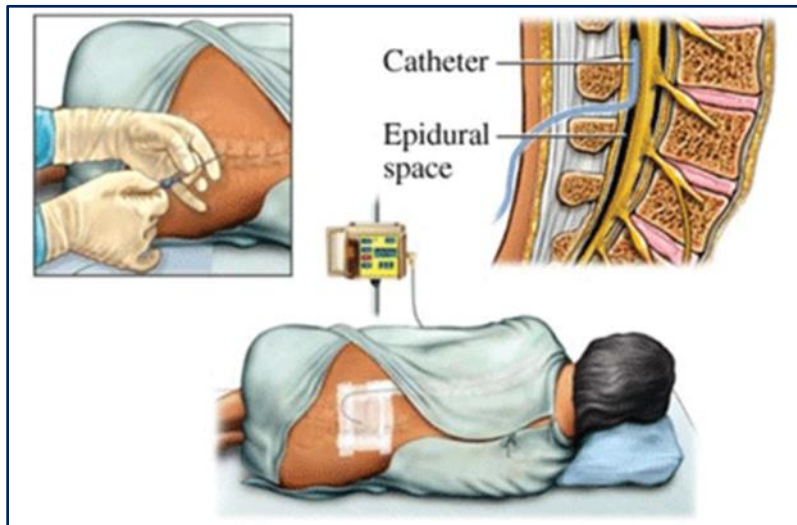

Parenteral Access: Ventricular Maintenance (PAS-6)

Procedure

1. Ensure catheter is secured in place
2. Maintain patient position during transport
 - A. Supine, head of bed elevated, etc. per referring physician directions
3. Maintain catheter drain height in relation to patient during transport per referring physician directions
4. Do not manipulate the catheter or drain

Additional Considerations

- * Do NOT adjust catheter position

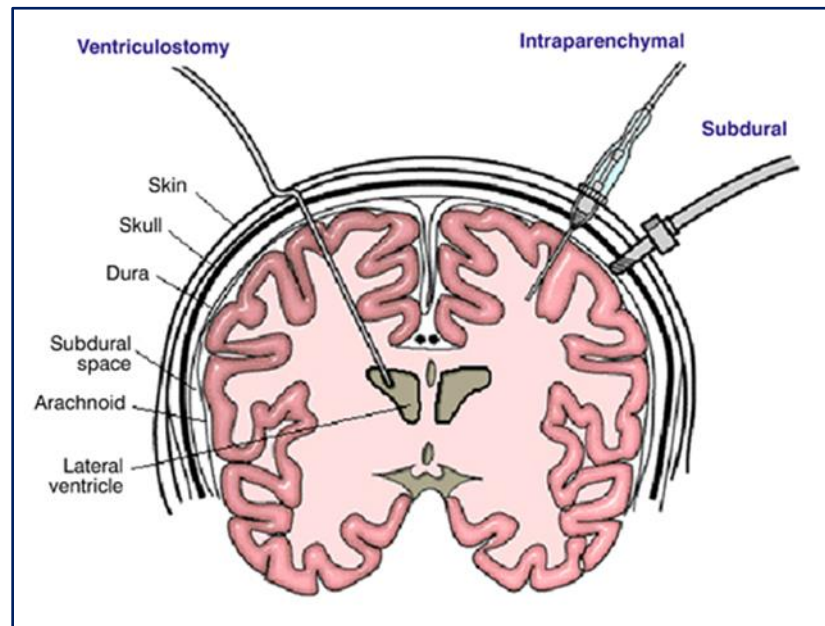

Parenteral Access: Existing Catheters (PAS-7)

Indications

- * Inability to obtain additional adequate peripheral access
- * Access of an existing venous catheter for medication or fluid administration
- * Central venous access in a patient in cardiac arrest

Procedure

1. Ensure catheter secured
2. Ensure no signs of infection present
3. Clean catheter port in standard aseptic fashion
4. Attempt flush with sterile saline
5. Assess for infiltration
6. If no difficulties: IVF or medication per appropriate protocol

Parenteral Access: External Jugular Access (PAS-8)

Indications

- * Need for IV access in a patient > 8-years of age with no extremity vein obtainable

Anatomy

- * The external jugular vein begins just posterior to the angle of the mandible
- * The EJV traverses inferiorly and diagonally over the sternocleidomastoid muscle
- * The EJV dives deep at the midpoint of the clavicle to empty into the subclavian vein

Contraindications

- * Absolute
 - Inability to locate landmarks (local hematoma, infection)
 - Subcutaneous emphysema (unless landmarks clearly identifiable)
- * Relative
 - Cervical collar – if access can be obtained without affecting cervical spine motion restriction then procedure may be performed

Complications

- * Hematoma
- * Infection
- * Phlebitis
- * Thrombosis



Procedure

1. Prepare equipment
2. Place patient in supine position in mild Trendelenburg (if no contraindications)
3. Turn head to opposite side (if no cervical spine precautions warranted)
4. Locate landmarks
5. Local aseptic prep as per peripheral IV site prep
6. Align angiocath over the vein with needle bevel toward the ipsilateral AC joint
7. "Tourniquet" the vein by pressing on it just superior to the clavicle
8. Puncture the skin @ 45° angle midway between the angle of the jaw and clavicle
9. Once blood return is noted advance the catheter over the needle
10. Remove needle and place gloved finger over the catheter to prevent air from entering
11. Attach IV tubing and set flow rate
12. Secure line in place with appropriate dressing or tape

Additional Considerations

- * Do not attempt opposite side of neck following unsuccessful attempt(s) on one side

Parenteral Access: Venous-Extremity (PAS-9)

Objective

- * Establishment of intravenous access for fluid resuscitation or medication administration in patients with an emergent or potentially emergent medical or traumatic condition

Procedure

1. Assess patient
 - A. Assess for need for IVF resuscitation
 - B. Assess for need for IV medication administration
2. Upper extremity sites are preferable to lower extremity sites
3. Establish peripheral IV
 - A. Follow standard IV catheter insertion procedure
 - i. Prepare equipment
 - ii. Place constricting band proximal to potential insertion site to restrict venous flow
 - iii. Select site and prep skin in standard aseptic fashion
 - iv. Place catheter over needle in standard fashion
 - v. Remove needle and flush catheter with sterile saline
 - vi. Place prn adapter and release constricting band
 - vii. Secure catheter/adapter in place in standard fashion
 - B. For trauma patients establish two (2) large bore IV lines (16G or larger)
4. For IVF
 - A. Fill drip chamber 1/2 full and flush tubing
 - B. Set drip at desired rate as per patient condition
5. If standard peripheral IV access not obtainable or additional access is required
 - A. External Jugular Line per [Parenteral Access: EJ Procedure Protocol](#)
 - B. Intraosseous Line per [Parenteral Access: IO Procedure Protocol](#)
6. If access is not obtainable
 - A. Contact Medical Control for possibility of accessing pre-existing indwelling venous catheters (Dialysis catheters)
 - i. Implanted ports should NOT be accessed as they require specialized needles/equipment not carried by MEDIC
 - B. Pre-existing indwelling venous catheters may be used without Medical Control contact in the event of cardiac arrest or life-threatening condition

Parenteral Access: Intraosseous (PAS-11)

Objective

- * To secure vascular access in a patient without a peripheral vein obtainable
- * MEDIC will utilize the EZ-IO™ device

Indications

- * Rapid, temporary vascular access when IV access is not readily available in a patient that is hemodynamically unstable or has potential to become hemodynamically unstable
- * Rapid, temporary vascular access when IV access is not readily available in a patient that requires emergent medication treatment
- * Cardiac Arrest

Contraindications

- * Absolute
 - Easily obtainable (and appropriate) peripheral access
 - Fracture in the same bone
 - Previous orthopedic procedures in same bone
 - Recent attempt at IO access in same bone
- * Relative
 - Infection / cellulitis in overlying skin
 - Burn in skin and tissue overlying the site
 - Significant pre-existing medical condition (tumor, peripheral vascular disease)
 - Obesity
 - Osteogenesis imperfecta

Anatomy

- * Primary site
 - Proximal tibia
 - Anteromedial surface
 - 2 cm distal to the tibial tuberosity
 - Utilize the blue or yellow needle-based amount of soft tissue to reach bone
- * Secondary sites
 - Humerus (patients > 40 kg)
 - Lateral aspect
 - 2 cm distal to the greater tuberosity
 - Utilize the yellow needle
 - Distal tibia
 - Anteromedial surface
 - 2 – 4 cm proximal to the medial malleolus, midline along the tibia

Equipment

- * EZ-IO™ driver
- * EZ-IO™ needle set
- * EZ-IO™ armband
- * Skin prep
- * Extension set
- * 10ml syringe
- * Normal saline IVF
- * Pressure bag
- * Lidocaine – 2% preservative free or 1% plain

Procedure

1. Locate insertion site and landmarks
2. Prep insertion site area with aseptic technique
3. For conscious patient – consider infusion of plain lidocaine locally at insertion site
4. Prepare EZ-IO™ driver and needle set
 - A. Select proper needle set (blue, or yellow) based on patient weight
 - B. Pink needle should only be selected for neonatal patients
5. Stabilize the extremity
6. Position needle perpendicular (90°) to the surface of the bone
7. Insert the EZ-IO™ needle set
 - A. Stop when needle flange touches the skin or sudden decrease in resistance is felt
 - B. At least one 5 mm mark should be visible above the skin once the needle is inserted
8. Remove the EZ-IO™ driver
9. Remove stylet from needle set
10. Confirm placement
 - A. Utilize syringe to aspirate blood and flush with 10 ml saline
11. For conscious patient consider for line comfort:
 - A. adults: 20 – 40 mg (1 – 2 ml) of lidocaine 2% (preservative free) IO
 - B. pediatrics: 0.5 mg/kg of lidocaine 2% (preservative free) IO
12. Secure needle in place
13. Connect IVF / medication(s)
 - A. Initiate infusion of IVF via pressure bag for adults
 - B. Utilize syringe for pediatric patients
14. Attach EZ-IO™ notification wristband on patient's wrist

Removal Procedure

1. Attach syringe to EZ-IO™
2. Turn clockwise pull gently pulling in a straight direction while applying pressure to the insertion site
3. Dress site with usual methods

Additional Considerations

- * For swelling or soft tissue infiltration noted at IO site – discontinue and remove needle
- * EZ-IO™ may remain in place for 24 hours
- * Place EZ-IO™ armband on patient to identify to subsequent care-givers of IO in place and date and time of insertion

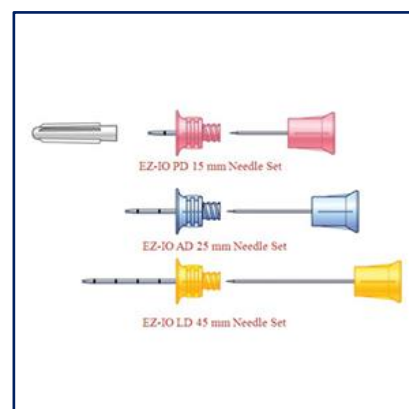
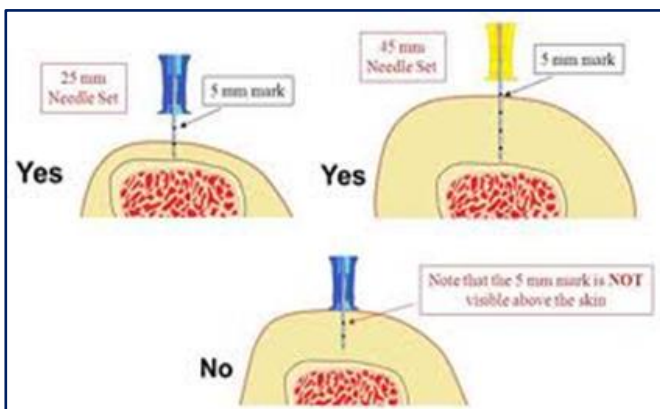
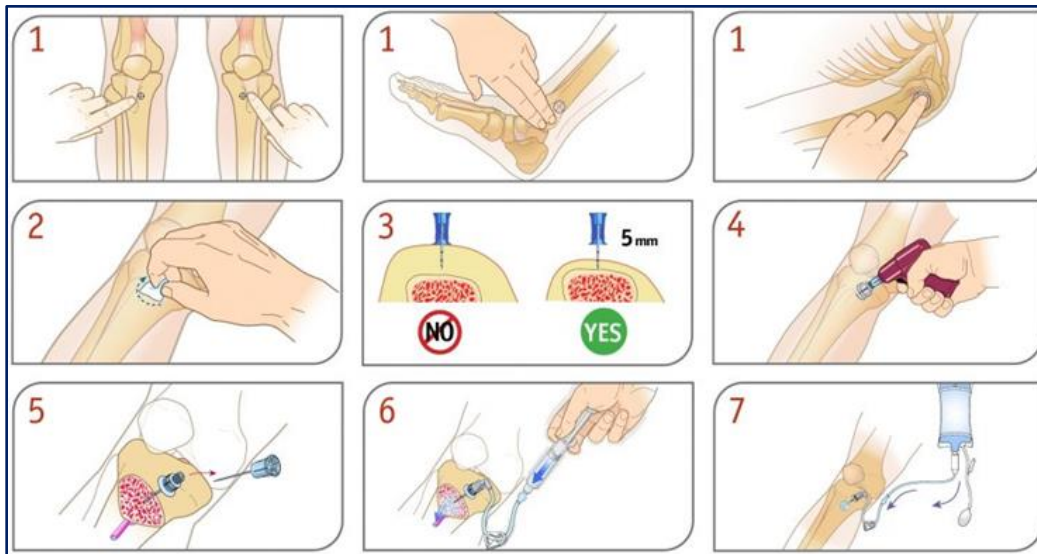

Parenteral Access: Swan Ganz Maintenance (PAS-12)

Procedure

1. Ensure the catheter is secured in place
2. Record the depth of insertion of the catheter
3. Do NOT manipulate the catheter during transport
4. Catheter ports may be utilized for continuation of fluids and / or medications
5. Catheter ports may be utilized for access during transport as needed utilizing standard sterile technique

Complications

- * Advancement of distal tip of catheter
- * Bleeding
- * Dysrhythmia – if tip of catheter is withdrawn to right ventricle of heart

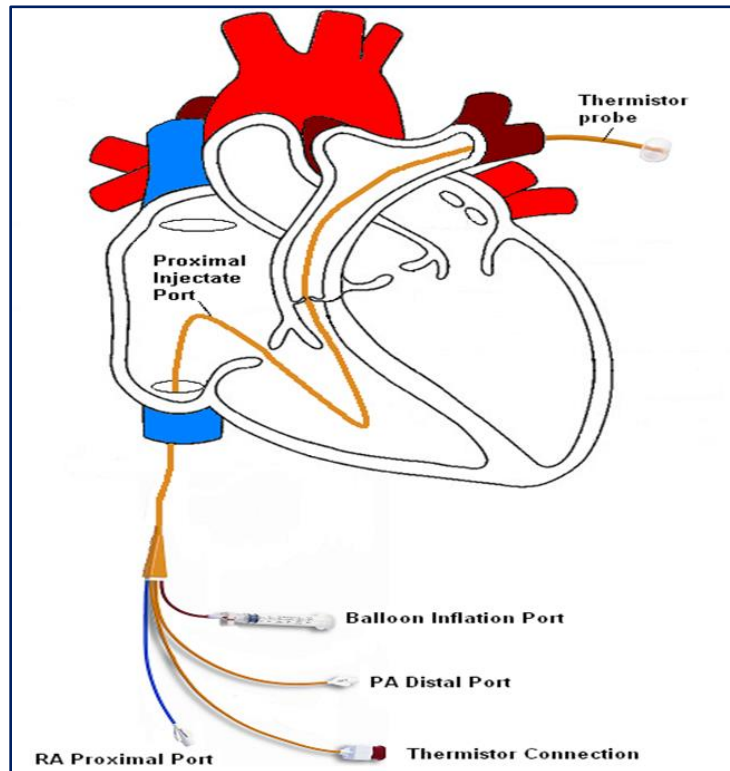

Respiratory: Suctioning Advanced (RSP-1)

Indications

- * Obstruction of airway of patient who can no longer maintain a clear airway
- * Obstruction of a previously placed airway device by secretions, blood, etc.

Contraindications

- * None

Complications

- * Aspiration
- * Hypoxia
- * Laryngospasm
- * Trauma
- * Vomiting

Procedure

1. Pre-oxygenate patient as indicated by patient condition
2. Prepare equipment
 - A. Flexible suction catheter
 - B. Suction tubing
 - C. Suction
 - D. Canister
3. Assess desired depth of suction catheter insertion through standard techniques
4. Remove patient from BVM or mechanical ventilation device if attached
5. Insert suction catheter into airway device
 - A. Ensure that thumb port of suction catheter is uncovered
 - B. Once desired depth of placement is reached occlude the thumb port and withdrawal the suction catheter
 - C. Small amount of normal saline may be instilled to loosen secretions if required
 - D. Suction time should not be > 5 seconds
6. Replace the ventilation device previously in use
7. Assess patient's response to suctioning
8. Repeat suctioning as indicated by patient condition

Respiratory: Suctioning Basic (RSP-2)

Indications

- * Obstruction of airway of patient who can no longer maintain a clear airway
- * Obstruction of a previously placed airway device

Contraindications

- * None

Complications

- * Aspiration
- * Hypoxia
- * Laryngospasm
- * Trauma
- * Vomiting

Procedure

1. Exam oropharynx and remove potential foreign bodies or other material which may occlude the airway
2. Preoxygenate patient as indicated by patient condition
3. Prepare equipment
 - A. Yankauer suction handle
 - B. Suction tubing
 - C. Suction canister
4. Place suction device into oropharynx
 - A. Alert and cooperative patient may be permitted to perform the suctioning themselves as desired
5. Assess patient's response to suctioning
6. Continue airway management as indicated by patient condition

Respiratory: Nebulizer Inhalation Therapy (RSP-3)

Indications

- * Bronchospasm

Contraindications

- * Acute congestive heart failure exacerbation

Complications

- * Nausea
- * Tachycardia
- * Tremors

Procedure

1. [Breathing Problems Protocol](#)
2. Assemble equipment in standard fashion
 - A. Nebulizer chamber
 - B. Mouthpiece
 - C. Oxygen tubing
3. Instill albuterol solution in nebulizer chamber and secure top with mouthpiece to chamber
 - A. Secure facemask to chamber if utilizing mask nebulizer
4. Connect device to oxygen source at adequate flow rate to produce steady visible mist
5. The patient needs to form a good seal around the mouthpiece and inhale normally
 - A. Place mask over patient's face if utilizing mask nebulizer
 - B. Ensure oxygen is on prior to placing mask over patient's face
6. Continue therapy until all the solution has been depleted
7. Assess response to therapy and repeat as indicated



Respiratory: NIPPV [CPAP] (RSP-4)

Indications

- * Respiratory distress due to pulmonary edema / CHF
- * Respiratory distress due to asthma / COPD
- * Respiratory distress due to pneumonia / aspiration
- * Submersion with possible aspiration
- * Toxic inhalation unresponsive to nebulizer therapy

Contraindications

- * Systolic BP < 80 mm Hg
- * GCS < 8
- * Age < 14 years
- * Uncooperative patient
- * Inability of patient to handle secretions
- * Respiratory distress due to trauma or possible pneumothorax

Procedure

1. Discuss procedure with the patient
2. Check equipment
 - A. Oxygen source
 - B. Tubing
 - C. Mask
3. Place patient in a comfortable
4. Ensure head of bed elevated $\geq 30^\circ$
5. Ensure continuous monitoring
6. Ensure adequate oxygen source to device
7. Place mask of device over patient's mouth & nose ensuring tight seal
8. Place harness on patient and adjust to ensure tight fitting seal and secure in place
9. Initiate positive pressure at 5 cm H₂O and slowly titrate to achieve optimum results

<u>Condition</u>	<u>Maximum pressure</u>
Congestive heart failure	5 – 15 cm H ₂ O
Toxic inhalation unresponsive to nebs	5 – 15 cm H ₂ O
Submersion with possible aspiration	5 – 15 cm H ₂ O
Asthma, COPD, reactive airway disease	3 – 15 cm H ₂ O

10. Assess patient's response to treatment
11. Adjust pressure as indicated by patient's response
 - A. Discuss with patient as pressure is increased
 - B. Minimize pressure adjustments as much as possible
12. Additional care per appropriate protocol

Additional Considerations

- * As per patient presumptive diagnosis provide albuterol via nebulization in-line with CPAP
- * Patient must be able to tolerate tight fitting mask and be able to cooperate with treatment
- * Frequently reassess vital signs check for respiratory response to therapy and watch for any cardiovascular complication to increased intra-thoracic pressure
 - Obtain vital signs and SpO₂ every 5 minutes while patient is on CPAP
 - Discontinue CPAP and assist ventilations with BVM (as indicated) for any of the following:
 - Blood pressure < 80 mmHg
 - Patient becomes somnolent or combative
- * Prior to arrival notify receiving facility CPAP device is in use



Respiratory: Respirator Operation (RSP-5)

Indications

- * Transport of intubated patient utilizing mechanical ventilator

Procedure

1. Confirm proper ETT position
2. Ensure adequate oxygen source connected
3. Utilized settings established by referring facility (or home for patients on chronic mechanical ventilation)
4. Assess for adequacy of oxygenation and ventilation
5. Continuous waveform capnography must be utilized throughout transport
6. Continuous pulse oximetry must be utilized throughout transport
7. For any worsening of patient condition, decrease in oxygen saturation, or any question regarding the function of the respirator, remove the respirator and resume bag-valve mask ventilations

Respiratory: Ventilator Operation (RSP-6)

Indications

- * Management of the ventilation of a patient during a prolonged or interfacility transport of an intubated patient

Procedure

1. Transporting personnel should review the operation of the ventilator with the treating personnel (physician, nurse, or respiratory therapist) prior to transport
 - A. Or with home care provider if patient coming from home on mechanical ventilator
2. All ventilator settings, including respiratory rate, FiO₂, mode of ventilation, and tidal volumes, PEEP should be recorded prior to initiating transport
3. Specific orders regarding any anticipated changes to ventilator settings as well as causes for significant alarm should be reviewed with the referring medical personnel
4. Once in the transporting unit, confirm adequate oxygen delivery to the ventilator
 - A. Continuous pulse oximetry must be utilized throughout transport
 - B. Continuous waveform capnography must be utilized throughout transport
5. Frequently assess the patient's respiratory status, noting any decreases in oxygen saturation or changes in tidal volumes, peak pressures, etc.
 - A. Frequently assess breath sounds to assess for possible tube displacement during transfer
 - B. Note any changes in ventilator settings or patient condition in the PCR
6. NG or OG tube should be placed in any acutely intubated patient to clear stomach contents
7. For any significant change in patient condition, including vital signs or oxygen saturation or there is a concern regarding ventilator performance/alerts, remove the ventilator from the endotracheal tube and use a bag-valve mask with 100% O₂
 - A. Contact medical control immediately

Additional Considerations

- * Troubleshooting **DOPE** mnemonic
 - **D**isplaced ETT, tracheostomy
 - **O**bstruction
 - **P**neumothorax
 - **E**quipment failure
- * Typical alarms
 - Low pressure/apnea
 - Loose or disconnected circuit
 - Leak in circuit or at tracheostomy site
 - Low power
 - Internal battery depletion
 - High pressure
 - Plugged/obstructed airway or circuit

Childbirth (USP-1)

Procedure

1. Gently control the progress of the head
2. Support the head with one hand as it is delivered
3. Clear the infant's airway by suctioning with bulb syringe
4. Check to ensure that the umbilical cord is not wrapped around the head / neck (nuchal)
 - A. Gently slip the cord over the head
 - i. If unable to easily slip over the head, it may be possible to slip it back over the shoulders and deliver the body through the loop
 - B. If necessary – unable to slip cord over the head; double-clamp and cut the cord between clamps (must ensure cord is not potentially cord of a twin gestation)
5. Help direct the anterior shoulder under the symphysis pubis with downward pressure on the side of the neonate's head
6. Apply gentle upward pressure to deliver the posterior shoulder
7. Support the infant through the remainder of the delivery
8. Clamp the cord approximately two (2) inches from the infant's abdomen and cut
9. Stimulate the infant and clear the airway
10. Dry and wrap the infant for warmth
11. Assess infants APGAR score at one and five minutes:
 - A. Deliver the placenta (never pull on the umbilical cord to deliver the placenta)
12. Massage the fundus of the uterus
13. Monitor for post-partum hemorrhage
14. Notify MCO, Obstetric team, and Neonatal team of emergent delivery
15. For prolapsed cord
 - A. Encourage mother to refrain from pushing
 - B. Place in Trendelenburg position
 - C. Insert fingers into vagina to relieve pressure on cord
 - D. Keep cord moist with saline soaked gauze
16. For breech presentation
 - A. Encourage mother to refrain from pushing
 - B. Place in Trendelenburg position
 - C. Support presenting part(s); do NOT pull
17. For Shoulder Dystocia
 - A. Hyperflex the mother's hips and thighs towards her chest and apply anterior to posterior pressure with lateral to medial pressure supra-pubic in attempt to rotate the baby's shoulders off the pelvic rim

Sign	0	1	2
Heart Rate	Absent	< 100 BPM	> 100 BPM
Respirations	Absent	Slow, irregular	Good, crying
Muscle Tone	Limp	Some flexion	Active motion
Reflexes	None	Grimace	Cough, sneeze, cry
Color	Blue	Pink, blue extremities	Pink

Decontamination (USP-2)

Indications

- * Required for any patient who has been exposed to significant hazardous material, including chemical, biological, or radiological weapons

Procedure

1. Personnel must be aware of established hot, warm, and cold zones of operation
 - A. MEDIC personnel should NOT enter hot or warm zones unless directed to do so by on scene Incident Command
 - i. This should only occur if emergent life threat is present requiring MEDIC crew management prior to completing patient decontamination
 - B. Personnel must ensure appropriate PPE is in use prior to entry into hot or warm zones
2. Ensure patients from the hot zone undergo appropriate initial decontamination
 - A. High volume water irrigation for liquids
 - B. Carefully brush off any solids
 - C. Removal of clothing
 - D. Irrigation of eyes as indicated
3. Perform initial triage following decontamination procedures
4. Immediate life threats should be addressed prior to technical decontamination
 - A. Personnel must ensure appropriate PPE is in place prior to contact with the patient
5. Patients should remove all clothing and wash gently with soap and water ensuring all body areas are cleansed
6. Ensure potentially contaminated patients have been appropriately decontaminated prior to loading into any ground vehicle
7. Additional care per appropriate protocol

Gastric Tube Insertion (USP-3)

Indications

- * Gastric decompression of intubated patients or patients with BIAD placed
- * Gastric decompression of patients with recurrent vomiting
- * Significant upper GI bleeding

Contraindications

- * Nasogastric Tube – significant closed head injury
 - Orogastric tube is preferred in intubated patients with a significant closed head injury or significant facial injury

Procedure

1. Prep nare(s) with oxymetazoline (Afrin®) or neosynephrine nasal spray as patient condition allows for nasogastric tube insertion
2. Estimate tube length required by standard fashion
3. Lubricate the distal end of the tube with KY jelly
4. Flex head
 - A. Contraindicated in patients with potential cervical spine injury
5. Insert tube and advance to desired length
6. Confirm placement via injecting air (20 – 30 ml) into proximal end of tube while performing epigastric auscultation
7. Secure tube in standard fashion
8. Place tube to appropriate suction
9. Assess patient's response to tube placement

Procedure via BIAD - Permitted to be placed by EMT

1. Estimate tube length required by standard fashion
2. Lubricate distal 6 - 8" of NG tube and pass into the gastric access lumen of the BIAD
3. Confirm placement via injecting air (20 – 30 ml) into proximal end of tube while performing epigastric auscultation
4. Secure in standard fashion
5. Place tube to appropriate suction
6. Assess patient's response to tube placement

Complications

- * Epistaxis
- * Passage of tube into the airway

Injections: Subcutaneous and Intramuscular (USP-4)

Indications

- * Medication administration

Complications

- * Bleeding from injection site
- * Infection
- * Pain at injection site

Procedure

1. Prepare equipment and medication dose in standard fashion
 - A. Verify medication and dose to be administered
2. Cleanse skin site in standard fashion
 - A. Upper arm preferred for SQ injections
 - B. Arm, buttock, or thigh preferred for IM injections
3. Insert needle into appropriate site in standard fashion
 - A. SQ: 45° angle to pinched skin
 - B. IM: 90° angle to flattened skin
4. Aspirate for potential blood
5. Inject medication
 - A. SQ medication volume should not exceed 1 ml
 - B. IM medication volume should not exceed 3 ml
6. Withdrawal needle
7. Gently massage injection site
8. Assess patient for response to medication

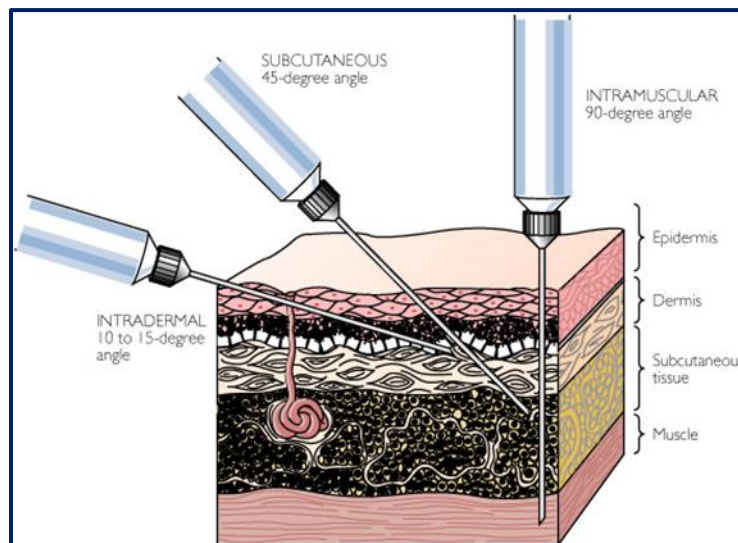

Injections: Intranasal

Indications

- * Administration of medication approved for intranasal administration

Complications

- * Bleeding
- * Sneezing
- * Rhinorrhea

Procedure

1. Prepare equipment and medication dose in standard fashion
 - A. Verify medication and dose to be administered
 - B. Prepare syringe with atomization device
2. Place patient in upright position
3. Insert atomization device into naris
 - A. Gently depress plunger of syringe in single motion to administer 50% of the dose
 - B. Repeat process in opposite naris for remaining dose
4. Assess patient for response to medication



Injections – Immunizations

Intranasal Procedure

1. Collect consent form and ensure that all patient information is complete
 - A. Ensure that all indications and contraindications to receiving the immunization are reviewed with and understood by the patient
2. Select medication per protocol and ensure that expiration date on sprayer has not been met or exceeded
3. Determine the appropriate dose that the sprayer or other delivery device contains
 - A. Most sprayers will contain a single complete dose of medication, half of which will be sprayed into each nostril
 - B. The syringe plunger will have a clip affixed to delineate where half the dose would be administered
4. Place the patient in an upright position
5. Gently insert the tip of the sprayer or delivery device into the external nares
6. Using a single motion, rapidly depress the plunger to administer the dose
 - A. Inject until the divider clip prevents further dosing
7. Remove the dose divider clip or similar device
8. Gently insert the tip of the sprayer or delivery device into the opposite external nares
9. Using a single motion, rapidly depress the plunger to administer the remaining dose
10. Monitor for allergic reaction
11. Dispose sprayer or other delivery device in appropriate biohazard or sharps container

Intramuscular Procedure

1. Collect consent form and ensure that all patient information is complete
2. Ensure that all indications and contraindications to receiving the immunization are reviewed with and understood by the patient
3. Select medication per protocol and ensure that expiration date on vial or container has not been met or exceeded
4. Determine the appropriate dose contained in the vial or container
5. Prepare all equipment:
 - A. Syringe and needle
 - B. Alcohol pad
6. Draw appropriate dose of medication in syringe and ensure that all air is removed
7. Select injection site and cleanse the area with aseptic technique
8. Perform intramuscular injection by standard technique
 - A. Aspirate to ensure absent blood return, and then inject medication
9. Massage injection site
10. Control bleeding
11. Apply dressing or bandage as necessary
12. Monitor for allergic reaction
13. Dispose equipment in appropriate biohazard or sharps container

Restraints: Physical (USP-5)

Objective

- * To provide guidelines relative to the use of patient restraints for patients at risk of harm to themselves or crewmembers

Guidelines

- * Crewmembers will perform a rapid assessment relating to the patient's mental and clinical status to adequately determine need for the use of restraints
- * The patient and crew safety are paramount while at the same time maintaining patient dignity and well being
- * Restraints may be used in an emergent situation, in response to dangerous behavior and to protect patients from harming themselves, any crewmember, or first responders
- * Chemical restraints may be combined with physical restraints to promote patient comfort
- * Physical restraints will not be used in a manner that causes undue physical discomfort, harm, or pain to the patient

Procedure

1. Attempt verbal de-escalation techniques
2. Assess the patients' mental and clinical status in determining the need for restraints
3. Request additional resources
 - A. Minimum of 5 medical providers are preferred to decrease injury potential
4. Patients should be restrained in supine or lateral positions only
5. Avoid applying restraints over clothing and shoes
6. Avoid constriction by placing two fingers between the restraining device and the patient
7. Document pulses and capillary refill distal to the restraining device every 15 minutes
8. Reassess patient throughout transport for need for continued restraints
9. Document clearly the reason(s) for which the patient requires chemical and/or physical restraints and any orders received from medical control

Additional Considerations

- * Patients must not be restrained in the prone position
- * If restraints are required for aggressive behavior, only authorized restraints are to be used
- * Modification of restraint devices or attempting to restrain patients using other devices or techniques (so called "homemade") is prohibited
- * As possible notify CMED of the intent to restrain the patient
 - o "Code 10-26 detaining", can be used to communicate the need to restrain a patient
- * CMED will notify the closest on-duty operations supervisor field for potential dispatch
 - o Do not delay patient treatment or restraints application awaiting a supervisor's arrival unless there is a safety concern necessitating need for OSF on site

Chest Decompression (WTP-1)

Objective

- * Improve hemodynamic function through relief of tension pneumothorax (pneumothorax with hemodynamic instability due to increased intrathoracic pressure)

Indications

- * Tension pneumothorax
- * Blunt traumatic cardiac arrest (bilateral)

Contraindications

- * Simple pneumothorax in hemodynamically stable patient

Clinical Presentation

- * History of blunt or penetrating trauma
- * Respiratory distress
- * Hypotension
- * Decreased or absent breath sounds
- * Jugular venous distension (late finding)
- * Tracheal deviation (late finding)
- * Positive pressure ventilations

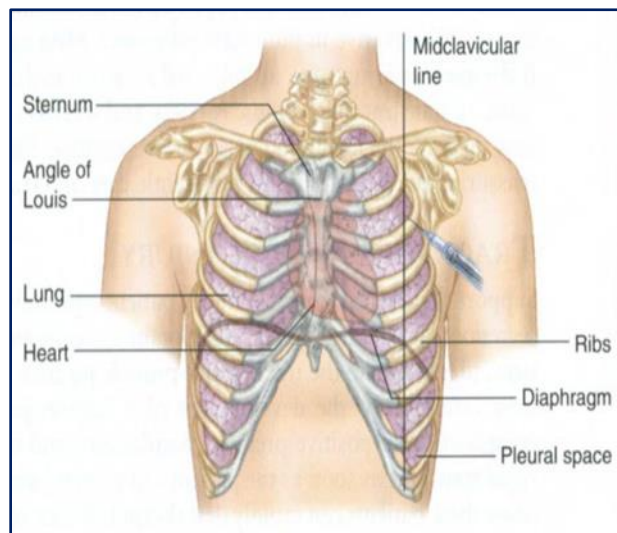

Procedure

1. Provide supplemental oxygen
2. Exposure chest
3. Identify landmarks
 - A. Affected side for tension pneumothorax
 - B. Bilaterally for blunt trauma arrest
4. Local prep with Betadine
5. Use **12 gauge 3 1/4" (8cm)** angiocath
6. Insert needle perpendicular to chest wall
 - A. Primary site = Mid-clavicular line just superior to 3rd rib (2nd intercostal space)
 - B. Alternate site = Mid-axillary line just superior to 5th rib (4th intercostal space)
7. Monitor for rush of air during insertion
8. Advance catheter fully
9. Remove needle leaving catheter in place
10. Secure catheter in place
11. Do not remove catheter prior to arrival once placed
12. If symptoms recur additional catheters may be required

Spinal Motion Restriction (WTP-2)

Indication

- * Traumatic injury with potential for spinal trauma
- * Patients should be placed in spinal motion restriction and transported in spinal motion restriction with a cervical collar in place if any of the following are present:
 - Abnormal mental status
 - Intoxicated or under the influence of mind-altering substance
 - Age < 5 years or > 65 years
 - Any posterior midline tenderness
 - Presence of distracting injury
 - Cervical pain with cervical range of motion
 - Patient unable to rotate neck 45 degrees to the left and to the right
 - Do NOT assess range of motion if the patient has any midline cervical spine tenderness to palpation
 - Any focal neurological deficit
 - High risk mechanism of injury
 - ATV crash
 - Ejection from vehicle
 - Fall > 3 feet (5 stairs)
 - High speed (>55 mph) or rollover MVC
 - Pedestrian or bicyclist struck by motor vehicle
 - Diving injury
- * Patient > 65-years of age & ground level fall should have spinal motion restriction with a cervical collar if any of the above criteria or if any evidence of trauma above the clavicles (this includes simple abrasions or minor contusions)

Additional Considerations

- * Patient with the above high risk mechanisms are to have SMR performed even there are not physical exam findings noted in the field
 - Example: MVC rollover at 60 MPH should have SMR performed even if no neck pain, tenderness, and normal neurologic exam
- * Always err on the side of performing SMR and placing a cervical collar if there is any doubt/concern

Procedure

1. Maintain manual spinal motion restriction until equipment gathered
2. Place appropriately sized cervical collar
3. Manual spinal motion restriction must be utilized during any patient movement
4. Remove appropriate clothing to fully inspect the spinal column
5. If the spine is not in a neutral position, gently realign
 - A. Immediately terminate the realignment procedure if the patient complains of increased pain, neurologic deficit or any symptom in any form, muscle spasm or resistance is encountered, airway compromise, it becomes physically difficult to realign, or the patient becomes apprehensive
6. For patient sitting in vehicle or similar position, carefully move by safest method to place supine on spine board maintaining in-line stability
 - A. Ensure that manual stabilization of the cervical spine is maintained throughout
7. Carefully transition patient to transporting EMS stretcher in supine position
 - A. Reassess for neurologic status
8. Carefully remove spine board to transport patient secured firmly on EMS stretcher
 - A. Ensure that manual stabilization of the cervical spine is maintained throughout
9. For a suspected spinal injury related to an athletic event where the patient has a helmet and shoulder pads in place, the following will be performed for motion restriction:
 - A. Helmet and shoulder pads should both be removed, or both remain in place
 - i. Do not remove one without removing the other
 - ii. May be removed if athletic trainer available to assist in removing and manual stabilization is maintained throughout the removal process
 - iii. If not removed apply in-line stabilization without traction to the cervical spine by holding both sides of the helmet
 - B. Gently remove the protective facemask
 - i. Athletic Trainer may provide tools and assistance to facilitate this process
 - C. Place patient on transport stretcher by standard technique, maintaining cervical spine control at all times
10. For suspected spinal injury related to an athletic event where the patient has a helmet, but no shoulder pads are in use, the follow will be performed for motion restriction:
 - A. Helmet may be removed if athletic trainer available to assist in removing and manual stabilization is maintained throughout the removal process
 - B. Apply in-line stabilization to the cervical spine by holding sides of the helmet
 - C. Gently remove the facemask (athletic trainer may be able to assist with this)
 - D. If helmet not removed, apply padding (blanket or sheets) on long spine board to ensure shoulders and back are raised to maintain neutral position of the spinal column
11. Carefully remove helmet, maintaining cervical spine stabilization if needed for airway compromise or indication for airway intervention occurs

Additional Considerations

- * Patient movement from position on ground onto long spine board for transition to EMS stretcher may be accomplished via several methods
 - Multi-person logroll maintaining cervical stabilization and spinal alignment during the maneuver process
 - Multi-person (6-8) lift utilizing 3-4 persons on each side of the patient and in unison lifting patient straight up and sliding long spine board in beneath patient from the feet of the patient
 - Coordinated decision as to the most appropriate method should be made amongst provider prior to patient movement
- * Spine boards or similar rigid devices, should NOT be used during transport or during inter-facility transfers
 - LSB should be utilized for extrication and / or patient transfers
 - Long or short spine board, scoop stretcher, soft-body splints, etc., should be considered extrication devices rather than transport-devices
- * Once the patient arrives at the stretcher, REMOVE the rigid spine board device while maintaining spinal alignment using log-roll or multi-rescuer lift techniques and transfer and secure to the stretcher for transport
- * Spinal Motion Restriction includes a rigid cervical collar, manual spine stabilization, maintaining spinal alignment with movement and transfers, and securing to the ambulance stretcher



Splinting (WTP-3)

Indications

- * Long bone fractures, severe sprains, or significant soft tissue injuries
- * Pelvic fracture

Procedure

1. [Pain Control Protocol](#)
2. Remove clothing as necessary to fully evaluate the extremity
3. Assess pulse, motor function, and sensation of extremity(ies)
 - A. For pulse diminished attempt reduction of fracture to anatomical position
4. Reassess pulse, motor function, and sensation after any fracture manipulation/splinting
5. Secure the splint proximal and distal to the fracture / injury site
6. Cover open fractures with sterile dressing

Additional Considerations

- * Pelvic splint
 - A. SAM Pelvic Sling®
 - Place white side of splint beneath patient at level of hips (femoral heads)
 - Close splint by placing black Velcro surface onto blue surface
 - Grab both orange handles and pull in opposite directions until “click” is heard and the free orange handle stops
 - Firmly press the orange handles against the blue surface

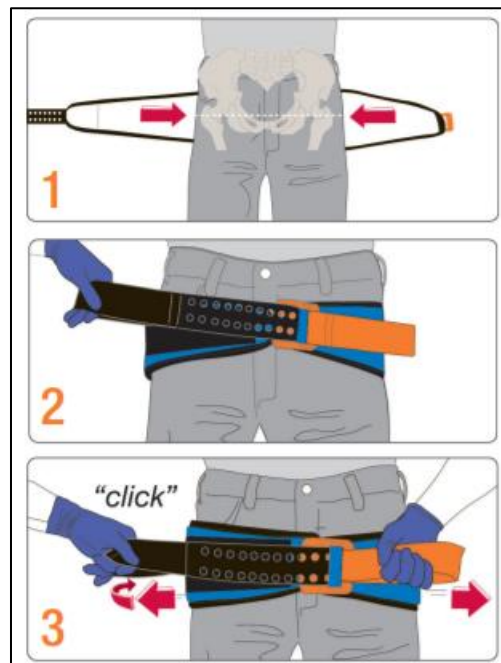

- Sheet splint
 - Place sheet folded lengthwise underneath patient at level of the hips
 - Pull opposite ends of sheet across the midline and tighten by twisting the opposite ends together
 - A small wooden rod or similar device may be used to help tighten the sheet
 - Secure in place
 - SAM splint is preferred over sheet binding
- * Femur splint
 - Place ankle device around ankle
 - Place the proximal end of splint posterior and as proximal to the pelvis as possible (avoid injury to the groin)
 - Secure groin strap
 - Extend the distal end of the splint approximately six (6) inches distal to foot
 - Utilize uninjured extremity to estimate length needed for splint
 - Attach the ankle device to the splint traction crank
 - Pull the femur out to length and secure the splint
 - Reassess pulse, motor function, and sensation
 - Hare traction contraindications
 - Pelvic fracture
 - Open femur fracture with gross contamination
 - Ankle fracture, distal amputation/partial amputation

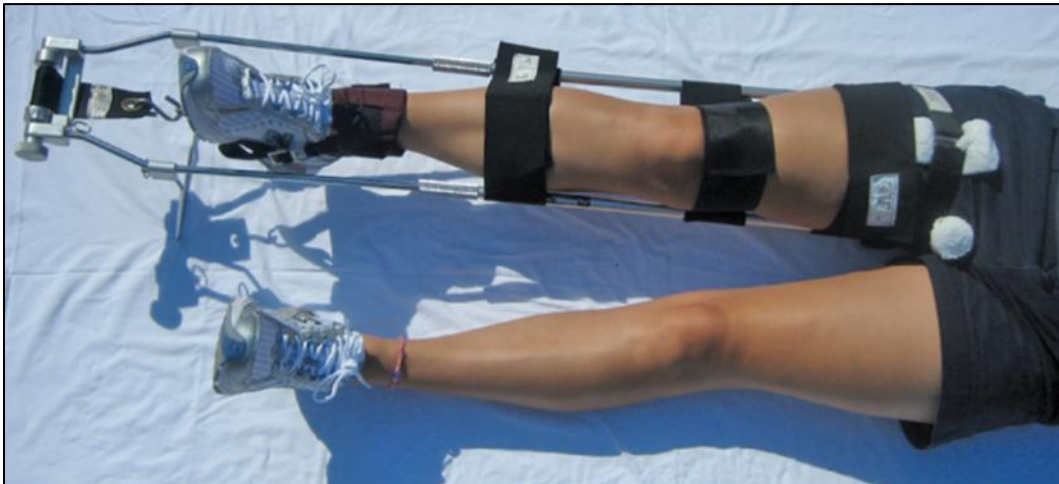

Tintinalli, JE, Stapczynski JD, Ma OD, Cline DM, Meckler GD; Tintinalli's Emergency Medicine : A Comprehensive Study Guide, 8th Edition

Wound Care – General (WTP-4)

Indications

- * Control of hemorrhage
- * Protection of open wounds

Procedure

1. Remove appropriate clothing to fully inspect the body for any significant wounds
2. Apply direct pressure to wounds to control bleeding
3. Irrigate contaminated wounds with saline as appropriate
4. Cover wounds with sterile gauze dressings
 - A. It may be appropriate to soak some wound dressings in sterile saline to keep underlying tissue moist
 - B. Burns should be dressed only with dry dressings
5. Assess distal motor, sensory, and vascular function before and after dressings are applied to extremity wounds
6. Reassess dressings throughout transport for evidence of re-bleeding

Wound Care – Hemostatic Agent (WTP-5)

Indications

- * Hemorrhage that cannot be controlled by direct pressure
- * Hemorrhage control not amendable to application of Mecklenburg EMS tourniquet or utilized in association with application of Mecklenburg EMS tourniquet
- * Mecklenburg EMS utilizes QuikClot® Combat Gauze

Contraindications

- * QuikClot® Combat Gauze cannot be utilized for open intra-abdominal wounds, open intra-thoracic wounds, or open skull wounds

Procedure

1. [Trauma Initial Assessment Protocol](#)
2. Apply QuikClot® Combat Gauze to wound
 - A. Examine wound and attempt to identify source of bleeding
 - i. May need to attempt to clear away any pooled blood over the bleeding source
 - B. Pack Combat Gauze directly over the source of bleeding in layering-type fashion
 - i. Gauze roll must be NOT be placed as a single rolled unit
 - ii. Gauze rolled must be placed in layered fashion, unrolling the gauze as it is placed in the wound
 - C. Utilize the entire gauze roll
 - D. Apply 3 minutes of direct pressure to the placed gauze
 - i. Do not lift dressing to re-assess the base of the wound
 - ii. For active bleeding and gauze is soaked through, completely remove the used gauze dressing and replace with a new roll utilizing same placement technique
3. Apply appropriate dressing to wound to secure gauze in place
4. Apply direct pressure to wound



Wound Care – Conducted Electrical Weapon (WTP-6)

Indications

- * Patient status post Conducted Electrical Weapon (CEW) deployment with embedded probe(s)

Contraindications

- * Probe embedded in neck, female breasts, or male/female genitalia
- * Patient uncooperative with field removal of embedded probe

Procedure

1. Assess for evidence of hyperactive delirium with severe agitation
 - A. Delusion, psychosis, altered mental status
 - B. Agitation, extreme excitement, violent behavior
 - C. Hyperthermia
 - D. Tachycardia
 - E. If present transport to Emergency Department for further evaluation
2. Provide necessary stabilizing patient care
3. Ensure probe wires disconnected from weapon
4. Removal will depend on the probe deployed
5. For Taser X26 or X2 probe
 - A. Stabilize skin with non-dominant hand
 - B. Firmly grasp probe with dominant hand and pull in single quick motion
6. For Taser 7 probe
 - A. Utilize probe installation cartridge from removal
 - B. Slide cartridge under probe and lift directly up

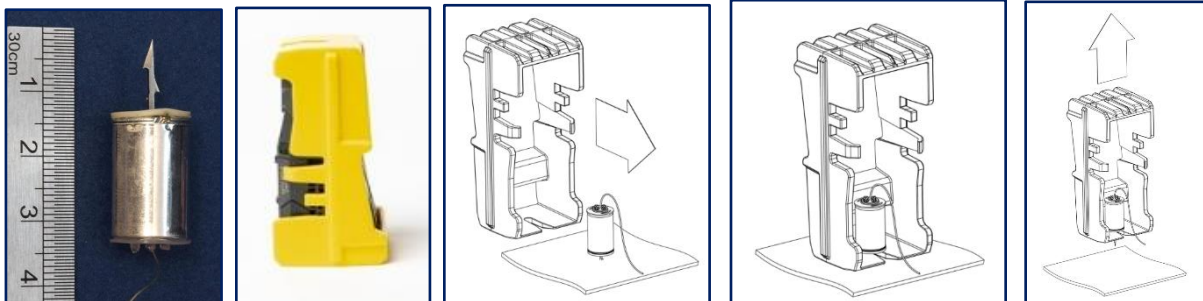
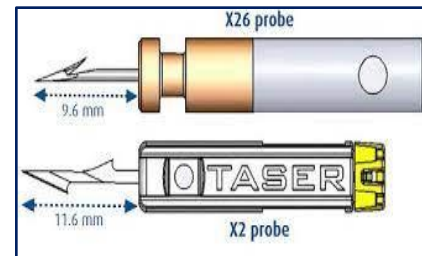

7. Confirm entire probe has been removed
 - A. If unable to remove, transport to emergency department for removal
8. Apply appropriate dressing to wound

Additional Considerations

- * Inform patient to update tetanus immunization within 7-days (if not up to date)
- * Injuries, e.g. extremity fractures, soft tissue contusions, and closed head injuries can occur after falls associated with the sudden loss of muscle control from a CEW
- * It is important to remember that the patient received a CEW deployment for reasons that were concerning to law enforcement personnel
 - Patient may have been uncooperative or combative, or under the influence of mind-altering substances
 - Etiological factors associated with such behavior may include alcohol intoxication, drug ingestion, overdose, psychosis, hypoxia, or hypoglycemia
- * Deaths associated with CEW utilization have been associated with *hyperactive delirium with severe agitation*
 - Hyperdopaminergic state characterized by extreme aggression, shouting, delusions, paranoia, strength, and hyperthermia
 - Often associated in cocaine users and requires aggressive treatment with benzodiazepines and IVF
- * CEW's devices do not affect pacemakers

Wound Care – Tourniquet (WTP-7)

Indications

- * Life threatening extremity hemorrhage that cannot be controlled by any other means
- * Uncontrollable extremity hemorrhage in patient with need for additional procedures/care (e.g. airway management)
- * Uncontrollable extremity hemorrhage in a patient involved of a mass casualty event with other patients requiring urgent/emergent medical attention

Contraindications

- * Hemorrhage to site where tourniquet application is not practical or would not provide necessary hemostasis
- * Non-extremity hemorrhage
- * Extremity hemorrhage able to be controlled with direct pressure

Procedure

1. Place tourniquet on upper arm or thigh proximal to the extremity wound
 - A. For upper extremity, loop may be advanced up the arm proximal to the wound
 - B. For lower extremity, unloop the tourniquet, wrap around the leg proximal to the wound and form loop through the friction buckle
 - C. Must ensure tourniquet is proximal to the most proximal wound
2. Pull the band tight until all slack removed
3. Twist the windlass rod until hemorrhage (bright red bleeding) stops
4. Secure the windlass rod within the windlass rod tri-ring
5. Note time tourniquet is placed (record time on tourniquet and in PCR)
6. Ensure radio report to destination facility includes use of a tourniquet



Additional Considerations

- * Tourniquet should optimally be place on portion of extremity with a singly bone, therefore upper arm or thigh



Section 5

Medication Formulary

Medication Formulary Advisory

EMT Personnel

- * The following medications contained within this list and contained within MEDIC's patient care protocols may be utilized by EMT Personnel
 - Acetaminophen (Tylenol®)
 - Aspirin
 - Albuterol (Proventil®)
 - Atropine via auto-injector in mass casualty exposure to nerve agents
 - Diphenhydramine (Benadryl®) PO
 - Epinephrine (1:1,000)
 - Nitroglycerin sublingual – only for patients currently prescribed nitroglycerin
 - Naloxone (Narcan®) intranasal route only
 - Oxygen

Paramedic Personnel

- * All medications contained within this list and contained within MEDIC's patient care protocols may be utilized by Paramedic Personnel

Additional Considerations

- * Personnel may not utilize medications that are NOT on the North Carolina Medical Board Approved Medications for Credentialed EMS Personnel List
- * The formulary concentrations included here are subject to change due to manufacturing supply – providers MUST assure the current stock concentration prior to administration
- * Patient RIGHTS for each medication administration
 - Right patient
 - Right medication
 - Right dose
 - Right route
 - Right time

Acetaminophen (Tylenol®)

Indications

- Pain control

Contraindications

- Known hypersensitivity reaction
- Significant liver disease

Mechanism of action

- inhibits the cyclooxygenase (COX) pathways

Dose adult

- 650 mg – 975 mg orally

Dose pediatric (> 3 months of age)

- 15 mg/kg orally (maximum 650 mg)

Adverse effects

- Angioedema
- Hepatotoxicity
- Rash

Protocols utilizing

- Fever
- Special Operations
- Additional protocols with need for analgesic management

How supplied

- 160 mg chewable tablet
- 325 mg/10.15 ml (32 mg/ml)

Administration

- Adult
 - chewable tablets: 3 – 5 PO
 - liquid: 20.25 ml PO
- Pediatric (> 3 months of age)
 - 15 mg/kg PO

Weight (kg)	10	15	20	25	30	35	40	45	50
Liquid (32 mg/ml)	4 ml	7 ml	9 ml	11 ml	14 ml	16 ml	18 ml	20 ml	20 ml
Chewable 160mg				2 tabs	2 tabs	3 tabs	3 tabs	4 tabs	4 tabs



Adenosine (Adenocard®)

Indications

- Supraventricular Tachycardia (SVT)

Contraindications

- Known hypersensitivity reaction
- 2nd or 3rd degree heart block
- Post heart transplant
- Wide complex irregular rhythm SVT (e.g. WPW with atrial fibrillation)
- Caution in patients with significant reactive airway disease history

Mechanism of action

- Slows/blocks conduction through the AV-Node

Dose adult

- 6 mg IV rapid push initial dose
- 12 mg IV rapid push subsequent dose(s)

Pediatric dose

- 0.1 mg/kg IV rapid push initial dose (maximum = 6 mg)
- 0.2 mg/kg IV rapid push subsequent dose(s) (maximum = 12 mg)

Adverse effects

- Bronchospasm
- Chest pain
- Dysrhythmia (asystole, v. fibrillation/tachycardia, bradycardia, a. fibrillation, Torsades)

Protocols utilizing

- Heart Problems – Supraventricular tachycardia
- Pediatric supraventricular tachycardia

How supplied

- Vial: 12 mg in 4 ml = (3 mg per ml)

Administration

- Initial dose: 2 ml (6 mg) rapid IV push & flushed with NS
- Subsequent: 4ml (12 mg) rapid IV push & flushed with NS
- Pediatric: 0.1 mg/kg rapid IV push

Pediatric Dosages (0.1 mg/kg)			(0.2 mg/kg)	
Weight (kg)	1 st Dose	Amount	2 nd Dose	Amount
10	1 mg	0.3 ml	2 mg	0.7 ml
15	1.5 mg	0.5 ml	3 mg	1 ml
20	2 mg	0.7 ml	4 mg	1.5 ml
25	2.5 mg	0.9 ml	5 mg	1.8 ml
30	3 mg	1 ml	6 mg	2 ml

Caveats

- 1/2 life < 10 seconds
- MUST have ECG rhythm strip printing (initiate prior administration)
- Will only CONVERT AV-Nodal Reentrant Tachycardia
- Will assist with diagnosis of other undefined SVT's

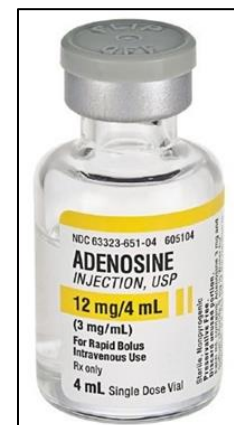

Albuterol (Proventil®)

Indications

- Reactive airway disease exacerbation (asthma / COPD)

Contraindications

- Known hypersensitivity reaction

Mechanism of action

- β -2 agonist
- Bronchodilation

Dose adult

- 5 mg nebulized solution

Dose pediatric

- 2.5 – 5 mg nebulized solution

Adverse effects

- Hypokalemia
- Nausea/vomiting
- Tachycardia
- Tremor/nervousness

Protocols utilizing

- Allergic Reaction
- Breathing Problems – asthma/COPD
- Heart Problems – hyperkalemia
- Drowning
- Smoke Inhalation

How supplied

- 2.5 mg in 3 ml (0.083% solution) nebule

Administration

- Nebulize via HHN
- Nebulize in-line via CPAP, BIAD, ETT
- Adults: 2 nebules
- Pediatrics: 1 – 2 nebules



Aspirin

Indications

- Chest pain consistent with cardiac etiology

Contraindications

- Known hypersensitivity reaction
- Known GI bleeding
- Pediatric age

Mechanism of action

- Anti-platelet aggregation via blocking formation of thromboxane A2

Dose adult

- 324 mg orally

Adverse effects

- Angioedema
- Bleeding
- Bronchospasm
- Nausea/vomiting
- Rash

Protocols utilizing

- Heart Problems – Chest Pain, Myocardial Ischemia
- Chest Pain Myocardial Infarction

How supplied

- 81mg chewable tablet

Administration

- 4 chewable tablets PO

Caveats

- Hold (must document) if patient has already taken aspirin prior to arrival
- Clinical performance measure:
 - Aspirin administration in STEMI
- Aspirin products
 - Anacin[®]
 - Bayer[®]
 - BC Powder[®]
 - Bufferin[®]
 - Ecotrin[®]
 - Excedrin[®]
 - Goody's[®]



Atropine

Indications

- Symptomatic bradycardia
- Organophosphate overdose
- Nerve agent exposure

Contraindications

- None

Mechanism of action

- Anticholinergic; blocks the parasympathetic nervous system

Dose adult

- 0.5 – 1 mg IV for symptomatic bradycardia
- 2 – 6 mg IV for organophosphate poisoning & repeated prn

Dose pediatric

- 0.02 mg/kg IV (minimum 0.1 mg; maximum 0.5 mg age < 8 years; 1 mg age > 8 years)

Adverse effects

- Tachycardia

Protocols utilizing

- Medical Monitoring – Hazardous Materials
- Carbon Monoxide Exposure
- Heart Problems – Bradycardia; Heart Block 2° type 1
- Pregnancy/Childbirth – Newly Born

How supplied

- 1 mg in 10 ml = (0.1 mg per ml) prefilled syringe

Administration

- IV push

Pediatric Dosages (0.02 mg/kg)		
Weight (kg)	Dose	Amount
5	0.1 mg	1 ml
10	0.2 mg	2 ml
15	0.3 mg	3 ml
20	0.4 mg	4 ml
25	0.5 mg	5 ml
30	0.6 mg	6 ml
35	0.7 mg	7 ml
40	0.8 mg	8 ml
45	0.9 mg	9 ml
50	1 mg	10 ml

Caveats

- Cardiac effects occur at the SA-Node
 - No effect for 2° type 2 or 3° heart block



Calcium Gluconate

Indications

- Hyperkalemia with ECG changes
- Calcium channel blocker overdose
- PEA arrest
- Refractory ventricular fibrillation
- Hypotension or respiratory depression due to magnesium toxicity

Contraindications

- Known hypersensitivity reaction
- Digoxin (Lanoxin®) toxicity

Mechanism of action

- Hyperkalemia: increases the myocardial threshold potential, restoring normal gradient

Dose adult

- 2 grams (20 ml of 10% solution) IV

Dose pediatric

- 20 mg/kg IV = 0.2 ml/kg (maximum 2 grams of 10% solution; 20ml)

Adverse Effects

- Bradycardia
- Hypotension

Protocols utilizing

- Cardiac Arrest
- Heart Problems
- Overdose
- Crush Injury

How Supplied

- 1,000 mg in 10 ml = (100 mg per ml); 10% solution

Administration

- IV slow push over 2 minutes

Pediatric Dosages (20 mg/kg)		
Weight (kg)	Dose	Amount
5	100 mg	1 ml
10	200 mg	2 ml
15	300 mg	3 ml
20	400 mg	4 ml
25	500 mg	5 ml
30	600 mg	6 ml
35	700 mg	7 ml
40	800 mg	8 ml
45	900 mg	9 ml
50	1000 mg	10 ml

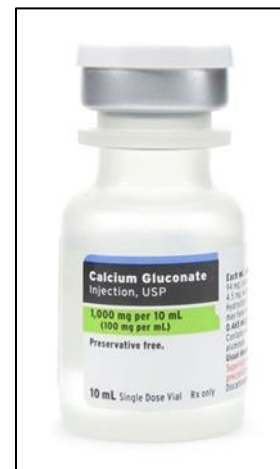

Cefazolin (Ancef®)

Indications

- Open skeletal fracture

Contraindications

- Known hypersensitivity reaction to cephalosporin (e.g. cefazolin, cefadroxil, cephalixin, ceftriaxone)
- Known anaphylaxis reaction to penicillin (e.g. amoxicillin, ampicillin)

Mechanism of action

- Cephalosporin antibiotic

Dose adult

- Weight \geq 120 kg: 3 grams IV over 10 minutes
- Weight 40 – 120 kg: 2 grams IV over 10 minutes

Dose pediatric

- N/A

Protocols utilizing

- Assault
- Falls
- Gunshot wound
- Industrial accident
- Stab wound
- Traffic accident
- Traumatic injury

How supplied

- 1 gram per vial

Administration

- Reconstitute with 10 ml saline
- SLOWLY push IV over 3 – 5 minutes
- Observe for adverse reaction



Dexamethasone

Indications

- Allergic reaction
- Reactive airway disease

Contraindications

- None

Mechanism of action

- Corticosteroid
- Anti-inflammatory

Dose adult

- 16 mg IV, IM, PO

Dose pediatric

- 0.6 mg/kg IV, IM, PO (maximum 16 mg)

Protocols utilizing

- Allergic Reaction
- Breathing Problem

How supplied

- 20 mg in 5 ml vial (4 mg/ml)

Administration

- Slow IV push
- Oral

Caveat

- Same medication can be utilized for IV/IM or PO dosing
- Medication does have a poor taste PO but can be utilized when IV access is unavailable

Pediatric Dosages (0.6 mg/kg)		
Weight (kg)	Dose	Amount
5	3 mg	0.75 ml
10	6 mg	1.5 ml
15	9 mg	2.25 ml
20	12 mg	3 ml
25	15 mg	3.75 ml
30	16 mg	4 ml
35	16 mg	4 ml
40	16 mg	4 ml
45	16 mg	4 ml
50	16 mg	4 ml

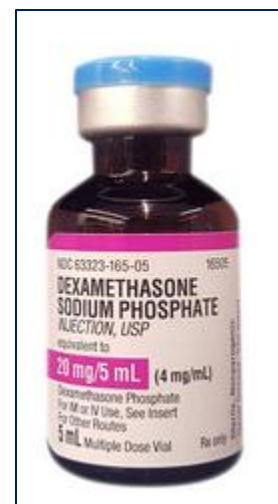

Diltiazem (Cardizem®)

Indications

- Supraventricular tachycardia (SVT)

Contraindications

- Known hypersensitivity reaction
- Hypotension
- Pediatric age

Mechanism of action

- Calcium channel blocker – prevents calcium flow through slow calcium channels
 - Negative chronotrope

Dose adult

- 15 mg IV over 2 minutes
- 20 mg IV over 2 minutes if no response to initial dose

Adverse Effects

- Bradycardia
- Hypotension

Protocols utilizing

- Heart Problems – SVT: Atrial Fibrillation; Atrial Flutter

How supplied

- 25 mg in 5 ml = (5 mg per ml)

Administration

- Initial dose: 3 ml (15 mg) IV push over 2 minutes
- Subsequent dose: 4 ml (20 mg) IV push over 2 minutes

Caveats

- Must be kept refrigerated prior to usage



Diphenhydramine (Benadryl®)

Indications

- Allergic reaction
- Dystonic reaction

Contraindications

- Known hypersensitivity reaction
- Age < 9 months

Mechanism of action

- Antihistamine (blocks H1 receptor)

Dose adult

- 25 mg – 50 mg IV, IM, PO

Dose pediatric

- 1 mg/kg IV, IM, PO (maximum dose = 50 mg)

Adverse effects

- Sedation
- Confusion

Protocols utilizing

- Allergic Reaction
- Psychiatric

How supplied

- Oral: 25 mg in 10 ml = (2.5 mg per ml)
- IV: 50 mg in 1 ml = (50 mg per ml)

Administration

- PO, slow IV push, or IM

Pediatric Dosages (1 mg/kg)			
Weight (kg)	Dose	Amount PO	Amount IV/IM
5	N/A	N/A	
10	10 mg	4 ml	0.2 ml
15	15 mg	6 ml	0.3 ml
20	20 mg	8 ml	0.4 ml
25	25 mg	10 ml	0.5 ml
30	30 mg	12 ml	0.6 ml
35	35 mg	14 ml	0.7 ml
40	40 mg	16 ml	0.8 ml
45	45 mg	18 ml	0.9 ml
50	50 mg	20 ml	1 ml

Caveats

- Pediatric patients > 9-months of age



Dopamine

Indications

- Hypotension despite adequate volume resuscitation

Contraindications

- Known hypersensitivity reaction
- Hypotension due to hypovolemia

Adverse Effects

- Chest pain/palpitations
- Tachycardia

Mechanism of action

- Dopamine receptor agonist
- With elevating doses stimulates α -receptors and β_1 -receptors

Dose adults

- 10 – 20 mcg/kg/min IV

Dose pediatrics

- 10 – 20 mcg/kg/min IV

Adverse effects

- Tachycardia
- Dysrhythmia
- Hypertension

Protocols utilizing

- Allergic reaction
- Cardiac Arrest
- Heart Problems
- Sick Person – Sepsis, Shock

How Supplied

- 400 mg in 250 ml pre-mixed bag – (1,600 mcg per ml)
- Alternate packaging:
 - 200 – 400 mg vial(s) to be mixed with D5W
 - IVF may be 250 ml – 1000 ml bag
 - Mixed all vials in accompanying IVF for end concentration of 1,600 mcg per ml (400 mg in 250 ml; 800 mg in 500 ml; 1,600 mg in 1000 ml)



Administration

- Continuous infusion @ 10 – 20 mcg/kg/min
- Rate = $\frac{\text{dose} * \text{kg} * 60}{\text{concentration}} = \frac{10\text{mcg}/\text{min} * 70\text{kg} * 60\text{min}}{1600\text{mcg}/\text{ml}} = 26.25 \text{ ml}/\text{hour} = 26.25\text{-gtts}/\text{min}$ (w/ 60-gtt set)

Wt (kg)	10 mcg/kg/min		15 mcg/kg/min		20 mcg/kg/min	
	mcg/min	ml/hour	mcg/min	ml/hour	mcg/min	ml/hour
60	600	22	900	34	1200	45
70	700	26	1050	39	1400	53
80	800	30	1200	45	1600	60
90	900	34	1350	51	1800	68
100	1000	38	1500	56	2000	75

Epinephrine

Indications

- Anaphylaxis
- Cardiac arrest: Asystole; PEA; Ventricular fibrillation
- Severe reactive airway disease

Contraindications

- None

Mechanism of action

- Stimulates α -receptors and β -receptors

Dose adults

- Cardiac arrest: 1 mg (1:10,000) IV, IO
- Anaphylaxis: 0.3 – 0.5 mg (1:1,000) IM

Dose pediatric

- Cardiac arrest: 0.01 mg/kg (1:10,000) IV, IO (max 1 mg)
- Anaphylaxis: BLS: 0.15 mg (1:1,000) IM (0.15 ml)
- ALS: 0.01 mg/kg (max 0.3 mg)
- Croup: Racemic
 - <5 kg: 0.25 ml (1/2 ampule) of 2.25% solution
 - \geq 5 kg: 0.5 ml (1 ampule) of 2.25% solution

Adverse Effects

- Hypertension
- Tachycardia

Protocols utilizing

- Allergic Reaction
- Breathing Problems – Asthma/COPD
- Breathing Problems – Croup
- Cardiac Arrest
- Heat Problems – Pediatric Bradycardia

How supplied

- Inhalation solution 2.25% for croup
- 1 mg in 1 ml vial = (1 mg per ml)

Administration

- Nebulized for croup
- IM for anaphylaxis, severe bronchospasm
 - Adult: 0.3 – 0.5 mg (0.3-0.5 ml)
 - Pediatric: BLS: 0.15 mg (0.15 ml)
 - ALS: 0.01 ml/kg; maximum 0.3 ml
- IV for cardiac arrest
 - Using the NS flush syringe, withdrawal the full contents of the vial into the 10ml syringe
 - Administer epinephrine IV from the flush syringe
 - Adults: 10 ml
 - Pediatrics: 0.01 ml/kg (max 10 ml)

Epi 1 mg/ml
for IM usage

Racemic
for croup



Epi kit for cardiac arrest



Fentanyl

Indications

- Opioid analgesic

Contraindications

- Known hypersensitivity reaction
- Hypotension
- Hypoventilation

Mechanism of action

- Synthetic opioid analgesic

Dose adult

- 0.5 – 1 mcg/kg IV, IM, IO (maximum 100 mcg)
- 1 – 2 mcg/kg IN (maximum 200 mcg)
- Repeat dose 1 mcg/kg (maximum 100 mcg any route)

Dose pediatric

- 0.5 – 1 mcg/kg IV, IM, IO (maximum 100 mcg)

Adverse Effects

- Respiratory depression
- Altered mental status
- Hypotension
- Chest wall rigidity (with rapid infusion)

Protocols utilizing

- Abdominal Pain
- Animal Bite
- Back Pain
- Chest Pain
- Electrocution
- Eye Problems
- Falls/Back Injury
- Headache
- Heart Problems
- Industrial Accident
- Stab Wound
- Traumatic Injury
- Traffic Accident
- Gunshot Wound

How supplied

- 100 mcg per 2 ml = (50 mcg per ml)

Administration

- Slow IV push

Caveats

- Decrease dose in older patients



Glucagon (GlucaGen®)

Indications

- Hypoglycemia in patients without IV access
- Altered mental status and unknown glucose level
- Hypotension secondary to beta-blocker or calcium channel blocker overdose

Contraindications

- Known hypersensitivity

Mechanism of action

- Promotes hepatic conversion of glycogen to glucose (glycogenolysis)
- Stimulates glucose synthesis (gluconeogenesis)
- Inhibits glucose breakdown (glycolysis)

Dose adult

- 1 mg IM

Dose pediatric

- ≤ 20 kg: 0.5 mg IM
- > 20 kg: 1 mg IM

Adverse Effects

- Hypotension

Protocols utilizing

- Allergic Reaction
- Altered Mental Status
- Diabetic Problem: Hypoglycemia
- Overdose (higher dosage)
- Sick Person
- Unknown Problem

How supplied

- 1 mg powder vial with 1 ml sterile water vial

Administration

- Utilizing the vial of sterile water, reconstitute glucagon powder
 - 1 mg in 1 ml
- Withdrawal reconstituted glucagon and administer IM

Caveats

- Limited utility in patients with poor glycogen stores
 - Severe liver disease
 - Severely malnourished
 - Newborns



Glucose

Indications

- Hypoglycemia
- Altered mental status and unknown glucose level

Contraindications

- None

Dose adult

- InstaGlucose®: one tube orally
- D10: 100-250ml IV

Dose pediatric

- > 8 years: D10 @ 5 ml/kg (maximum 100ml)
- 31 days – 8 years: D10 @ 2 ml/kg (maximum 100 ml)
- 0 – 30 days: D10 @ 2 ml/kg
- Repeat as indicated

Adverse Effects

- Hyperglycemia

Protocols utilizing

- Altered Mental Status
- Diabetic Problems: Hypoglycemia
- Newly Born
- Psychiatric
- Sick Person
- Unknown Problem

How supplied

- 31-grams dextrose gel in tube
- 10% dextrose in 250 ml NS
 - 250 ml = 25 grams dextrose

Administration

- PO gel
 - Patient must be alert with an intact gag reflect to take oral administration
- IV, IO push



Ibuprofen (Motrin®)

Indications

- Pain control
- Anti-inflammatory

Contraindications

- Known hypersensitivity reaction
- Significant renal insufficiency

Mechanism of Action

- Inhibits prostaglandin production by decreasing activity of the cyclooxygenase

Dose adult

- 600 mg – 800 mg orally

Dose pediatric

- 15 mg/kg orally (maximum 400 mg)

Adverse Effects

- GI distress
- Nephrotoxicity
- Rash

Protocols utilizing

- Special Operations

How supplied

- 200 mg tablet

Administration

- 3 – 4 tablets PO



Ketamine (Ketalar®)

Indications

- Sedation of combative/violent patient for patient &/or provider safety
- Attempt verbal de-escalation prior to administration

Contraindications

- Known hypersensitivity

Mechanism of Action

- Dissociative anesthetic
 - N-methyl-D-aspartate (NMDA) and glutamate receptor antagonist
- Partial opiate mu-receptors agonist

Dose adult

- 3 mg/kg IM; maximum 300 mg
- Single repeat dose: 1.5 mg/kg IM (maximum 150mg)

Dose pediatric

- Requires consultation with Medical Director or EMS Fellow

Adverse Effects

- Emergence reaction (possible hallucinations) – midazolam per medical control
- Hypertension
- Increased airway secretions – airway suctioning
- Laryngospasm – BVM ventilation
- Nausea, vomiting – ondansetron per protocol
- Nystagmus

Protocols utilizing

- Psychiatric
 - Significant agitation associated with BARS score = 7 or severe agitation with potential risk to patient and/or providers

How Supplied

- 500 mg in 5 ml (100 mg per ml)

Caveats

- For clinical care use only
 - Not to be administered for law enforcement purposes or request
- ETCO₂ monitor via nasal cannula must be utilized
- SpO₂ monitoring must be utilized
- With any utilization, documentation must include clear indications for administration
- Any utilization must be reported to the medical director



Labetalol (Normodyne®)

Indications

- Hypertensive emergency associated with acute cerebrovascular accident with Medical Control order
- Hypertensive emergency associated with pre-eclampsia / eclampsia

Contraindications

- Known hypersensitivity reaction

Mechanism of action

- Blocks α -1 and β -1 & 2 receptors

Dose adult

- Hypertensive emergency: 20 mg IV

Adverse Effects

- Hypotension
- Nausea

Protocols utilizing

- Pregnancy & Childbirth
- Sick Person
- Stroke
- Unknown Problem

How supplied

- 100 mg in 20 ml (5 mg per ml)

Caveats

- Can be given via standing protocol for pre-eclampsia and eclampsia
- Contact medical control prior to administration in other hypertensive states
- Contact medical control prior to administration in patients who have recently or are suspected of having recently ingested cocaine
 - B-blockade may lead to some additional α action and further increase blood pressure



Lidocaine

Indications

- Ventricular ectopy
- Cardiac arrest – ventricular fibrillation; ventricular tachycardia
- Analgesia related to IO line insertion

Contraindications

- Known hypersensitivity reaction
- 2nd degree type 2 & 3rd degree heart block

Mechanism of action

- Class 1B anti-arrhythmic
 - Blocks sodium channels
 - Decreases myocardial automaticity
- Local anesthetic
 - Blocks sodium channels

Dose adult

- Cardiac
 - 0.75 – 1.5 mg/kg IV bolus initial dose
 - 0.5 – 0.75 mg/kg IV bolus repeat dose
- IO analgesia
 - 20 – 40 mg (1 – 2 ml) IO

Dose pediatric

- Cardiac
 - 1 mg/kg IV bolus for ventricular ectopy, cardiac arrest
 - 0.5 mg/kg IV bolus repeat dose for ventricular ectopy or cardiac arrest
- IO analgesia
 - 0.5 mg/kg IO

Adverse Effects

- Seizure (with toxicity)

Protocols utilizing

- Cardiac arrest: VFib, VTach; Post-Resuscitation
- Venous Access: Intraosseous

How supplied

- 100 mg in 5 ml = (20 mg per ml) prefilled syringe

Administration

- Cardiac arrest
 - IV push
- IO analgesia
 - Slow IO push



Magnesium sulfate

Indications

- Obstetric: Pre-eclampsia / Eclampsia; Pre-term labor
- Cardiac: Refractory ventricular fibrillation / ventricular tachycardia; Torsades des points
- Pulmonary: Refractory bronchospasm

Contraindications

- Renal Failure

Adverse Effects

- Hypotension
- Respiratory depression

Mechanism of action

- Bronchospasm: bronchial smooth muscle relaxation
- Torsades: decreases influx of calcium suppressing early afterdepolarizations
- Eclampsia: depresses the CNS producing anticonvulsant effects

Dose adult

- Obstetric indications: 4 grams IV
- Cardiac indications: 1 – 2 grams IV
- Pulmonary indications: 1 – 2 grams IV

Dose pediatric

- 25 – 50 mg/kg IV (maximum = 1 gram)

Protocols utilizing

- Cardiac Arrest
- Breathing Problem
- Heart Problem
- Pregnancy & Childbirth

How supplied

- 1 gram per 2 ml vial = (500 mg per ml) 50%

Administration

- IV usage must be diluted with NS
- Bronchospasm
 - Adult: 1 – 2 grams over 5 – 10 minutes
 - Pediatric: 25 – 50 mg/kg over 5 – 10 minutes
- Eclampsia
 - Dilute 4 grams in 150 ml NS
 - Infuse over 15 minutes



Midazolam (Versed®)

Indications

- Sedation
- Seizure

Contraindications

- Hypotension

Mechanism of action

- Benzodiazepine: enhances CNS activity of gamma-amino-butyric-acid (GABA)

Dose adult

- 5 mg IV (do NOT use IV for seizure)
- 10 mg IM, IN
- May repeat at 10 – 15-minute intervals as needed following reassessment

Dose pediatric

- 0.15 mg/kg IV (max 5 mg) (do NOT use IV for seizure)
- 0.2 mg/kg IM, IN (max 10 mg)
- May repeat at 10 – 15-minute intervals as needed following reassessment

Adverse Effects

- Confusion
- Hypotension
- Respiratory depression

Protocols utilizing

- Seizure
- Psychiatric
- Cardiac: Cardioversion
- Cardiac: Transcutaneous pacing

How supplied

- 5 mg in 1 ml

Administration

- IV, IM or IN

Caveats

- ETCO₂ monitoring via nasal cannula to be utilized
- Only administer IM or IN for seizure control



Naloxone (Narcan®)

Indications

- Suspected narcotic overdose

Contraindications

- None

Mechanism of action

- Opioid antagonist

Dose adult

- 1 – 2 mg IV, IN, IO, IM

Dose pediatric

- 0.01 – 0.1 mg/kg IV, IN, IO, IM (maximum 2 mg)

Adverse effects

- Nausea/vomiting
- Precipitation of opioid withdrawal symptoms

Protocols utilizing

- Altered Mental Status
- Overdose / Toxic Ingestion

How supplied

- 2 mg in 2 ml (1 mg per ml)

Administration

- IV Push
- IN Via atomizer
 - ½ dose in each nostril
- Repeat Q 5" as indicated
 - Maximum total dosage = 10 mg

Caveats

- May precipitate narcotic withdrawal in patients on long-term narcotic medication
 - Concern for potential opioid withdrawal is secondary to reversing of respiratory depression
- IM is the least preferred route of administration and should only be utilized if other routes are unavailable
- PD and some first responders may have formations that provide a 4 mg dose

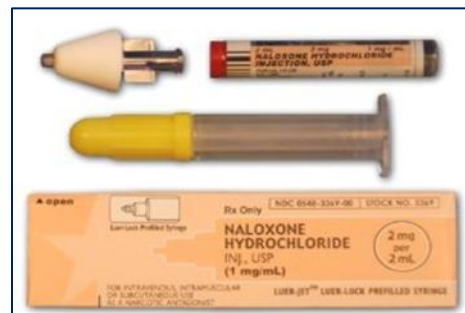

Nitroglycerin (Nitrostat[®], Nitro-BID[®])

Indications

- Chest pain consistent with inadequate coronary perfusion
- Hypertensive emergency
- Pulmonary edema

Contraindication

- Hypotension
- sildenafil (Viagra[®]), tadalafil (Cialis[®]), vardenafil (Levitra[®]) or similar drug in past 24 hours

Mechanism of action

- Vasodilator

Dose adult

- 0.4 mg SL
- Repeat every 5 minutes as required by patient condition
- 1" – 2" paste to upper chest wall

Adverse Effects

- Headache
- Hypotension

Protocols utilizing

- Hypertension
- Pulmonary Edema
- Cardiogenic Shock
- Heart Problems

How supplied

- Sublingual tablets
 - 0.4 mg per tablet
- Paste
 - 15 mg per 1"

Administration

- Tablets
 - 1 tablet sublingual Q 5' as indicated
- Paste
 - 1"– 2" topical per measured BP (1 packet = 1")

Caveats

- Caution in patients with a right ventricular STEMI (inferior wall)
 - May adversely affect preload



Nitrous Oxide

Indications

- Acute pain management

Contraindications

- Bowel obstruction
- Hypotension
- Pneumothorax
- Pregnancy (patient or provider)
- Significant respiratory compromise

Mechanism of action

- Stimulation of Mu receptor in CNS = analgesia
- Stimulation of GABA receptor in CNS = anxiolysis

Dose adult

- 50:50 mixture via self-administered device

Dose pediatric

- 50:50 mixture via self-administered device

Protocols utilizing

- Multiple

How supplied

- Preset 50:50 mixture N₂O:O₂

Administration

- Via patient-controlled inhalation device



Ondansetron (Zofran®)

Indications

- Recurrent nausea or vomiting

Contraindications

- Known hypersensitivity reaction

Mechanism of action

- Serotonin 5-HT₃ receptor antagonist

Dose adult

- 4 – 8 mg IV, IM, PO

Dose pediatric

- 0.15 mg/kg IV, IM, PO (for > 6 months of age; maximum = 4 mg)

Protocols utilizing

- Sick Person
- Headache
- Overdose
- Carbon Monoxide/Hazardous Materials Exposure

How supplied

- Oral
 - 4mg disintegrating table
- IV
 - 4 mg in 2 ml = (2 mg per ml)

Administration

- Oral
 - Adult: 1 – 2 ODT on tongue
 - Pediatric: (0.14 mg/kg) 1 ODT on tongue
- IV
 - Adult: 4 – 8 mg slow IV push
 - Pediatric: 4 mg slow IV push



Oxygen

Indications

- Chest pain
- Hypoxia
- Preoxygenation for intubation, BIAD insertion, suctioning
- Respiratory distress

Contraindications

- None

Dose adult

- Dependent on patient condition to maintain $SpO_2 = 94 - 97\%$
 - 1 L – 6 L/min nasal cannula
 - 10 L – 15 L/min non-rebreather mask
 - 15 L/min BVM

Dose pediatric

- Dependent on patient condition to maintain $SpO_2 = 94 - 97\%$
 - 1 L – 6 L/min nasal cannula
 - 10 L – 15 L/min non-rebreather mask
 - 15 L/min BVM

Protocols utilizing

- Any

Sodium bicarbonate

Indications

- Cardiac arrest with prolonged resuscitation time
- Severe acidosis (pH < 7.0)
- Significant hyperkalemia
- Tricyclic antidepressant overdose with ECG changes
- Significant crush injury

Contraindications

- Known hypersensitivity

Mechanism of action

- Plasma buffer (HCO_3^-)
- Sodium electrolyte (Na^+)

Dose adult

- 1 amp – 1 mEq/kg IV, IO

Dose pediatric

- 1 mEq/kg IV, IO

Protocols utilizing

- Cardiac Arrest
- Traumatic Injury – crush injury
- Heart Problems – dysrhythmia consistent with hyperkalemia
- Overdose

How supplied

- 50 mEq in 50 ml = (1 mEq per ml)

Administration

- Adult: 50 ml IV, IO
- Pediatric: 1 ml/kg IV, IO

Caveats

- For TCA overdose with ECG changes, it is the amount of sodium that is most beneficial
- For severe crush injury/syndrome administer immediately prior to extrication or during entrapment if prolonged entrapment is anticipated



Sodium thiosulfate

Indications

- Potential cyanide poisoning

Contraindications

- Known hypersensitivity reaction

Mechanism of action

- Sulfur donor facilitating the conversion of cyanide to thiocyanate

Dose adult

- 12.5 grams IV

Dose pediatric

- 250 mg/kg IV (maximum = 12.5 grams)

Adverse Effects

- Hypotension
- Nausea/vomiting

Protocols utilizing

- Burns
- Carbon monoxide / toxic inhalation

How supplied

- 12.5 gm in 50 ml = (250 mg per ml)

Administration

- Slow IV push
 - Adults 50 ml IV (12.5 grams)
 - Pediatric: 1 ml/kg (maximum = 50 ml; 12.5 grams)

Caveats

- Administered for altered mental status or severe acidemia
- Medication is stored in drawer 3 of patient compartment





Section 6

Appendix

START Triage (UP-2)

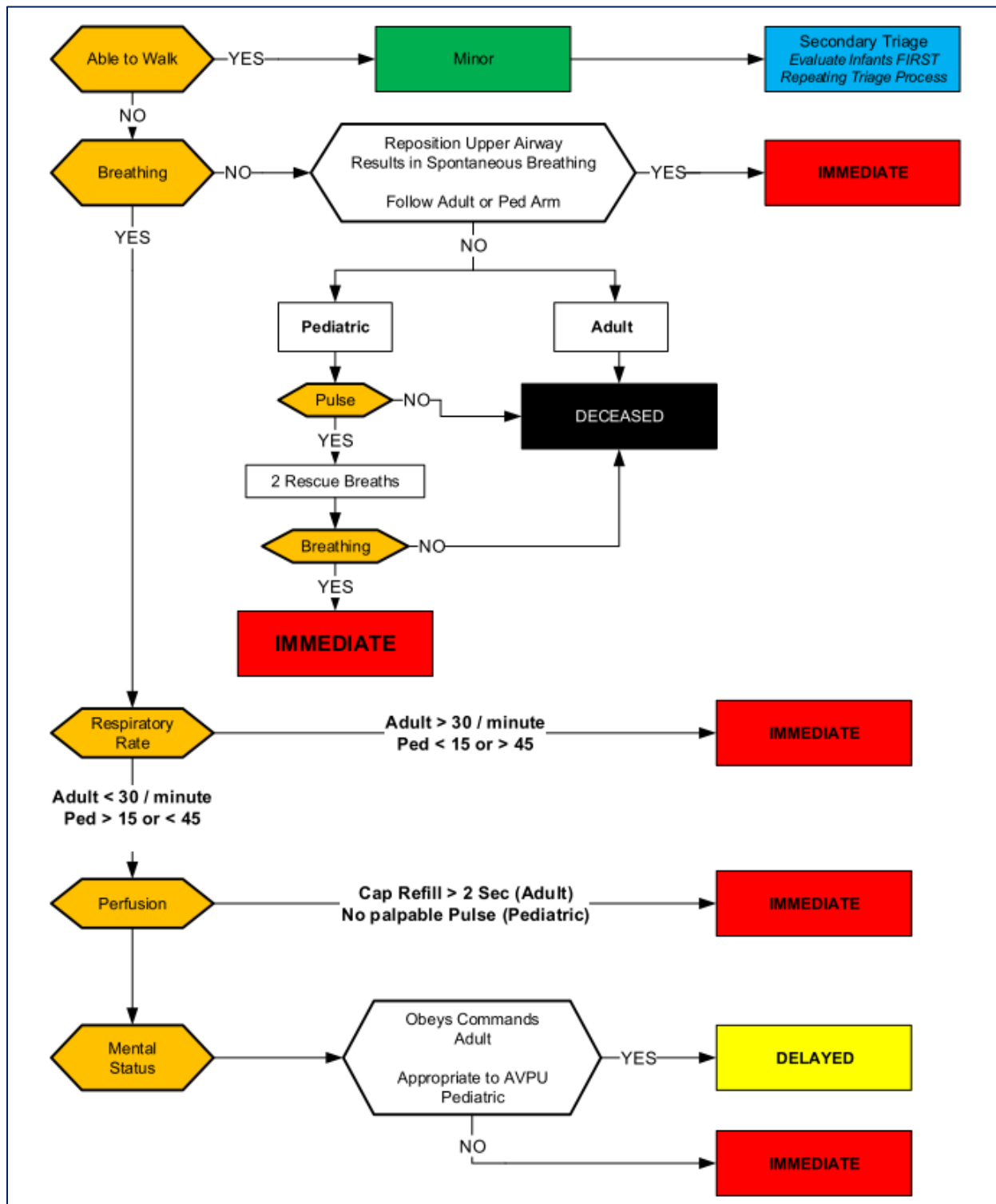

Patient Instructions

UNIVERSAL INSTRUCTIONS:

- YOU HAVE NOT RECEIVED A COMPLETE MEDICAL EVALUATION. SEE A PHYSICIAN AS SOON AS POSSIBLE.
- IF AT ANY TIME AFTER YOU HAVE TAKEN ANY MEDICATION, YOU HAVE TROUBLE BREATHING, START WHEEZING, GET HIVES OR A RASH, OR HAVE ANY UNEXPECTED REACTION, CALL 911 IMMEDIATELY.
- IF YOUR SYMPTOMS WORSEN AT ANY TIME, YOU SHOULD SEE YOUR DOCTOR, GO TO THE EMERGENCY DEPARTMENT OR CALL 911.

ABDOMINAL PAIN:

- Abdominal pain is also called belly pain. Many illnesses can cause abdominal pain and it is very difficult for EMS to identify the cause.
- Take your temperature every 4 hours.

Call or see a physician, go to the emergency department, or call 911 immediately if:

- Your pain gets worse or is now only in 1 area
- You vomit (throw up) blood or find blood in your bowel movement
- You become dizzy or faint
- Your abdomen becomes distended or swollen
- You have a temperature over 100° F
- You have trouble passing urine
- You have trouble breathing

BACK PAIN:

- Apply heat to the painful area to help relieve pain. You may use a warm heating pad, whirlpool bath, or warm, moist towels for 10 to 20 minutes every hour.
- Stay in bed as much as possible the first 24 hours.
- Begin normal activities when you can do them without causing pain.
- When picking things up, bend at the hips and knees. Never bend from the waist only.

Call or see a physician, go to the emergency department, or call 911 immediately if:

- You have shooting pains into your buttocks, groin, legs, or arms or the pain increases.
- You have trouble urinating or lose control of your stools or urine.
- You have numbness or weakness in your legs, feet, arms, or hands.

FEVER:

- Always take medications as directed. Tylenol and Ibuprofen can be taken at the same time.
- If you are taking antibiotics, take them until they are gone, not until you are feeling better.
- Drink extra liquids (1 glass of water, soft drink or gatorade per hour of fever for an adult)
- If the temperature is above 103° F, it can be brought down by a sponge bath with room temperature water. Do not use cold water, a fan, or an alcohol bath.
- Temperature should be taken every 4 hours.

Call or see a physician, go to the emergency department, or call 911 immediately if:

- Temperature is greater than 101° F for 24 hours
- A child becomes less active or alert.
- The Temperature does not come down with Acetaminophen (Tylenol) or Ibuprofen with the appropriate dose.

HEAD INJURY:

- Immediately after a blow to the head, nausea, and vomiting may occur.
- Individuals who have sustained a head injury must be checked, and if necessary awakened, every 2 hours for the first 24 hours.
- Ice may be placed on the injured area to decrease pain and swelling.
- Only drink clear liquids such as juices, soft drinks, or water the first 12 hours after injury..
- Acetaminophen (Tylenol) or Ibuprofen only may be used for pain.

Call or see a physician, go to the emergency department, or call 911 immediately if:

- The injured person has persistent vomiting, is not able to be awakened, has trouble walking or using an arm or leg, has a seizure, develops unequal pupils, has a clear or bloody fluid coming from the ears or nose, or has strange behavior.

INSECT BITE/STING:

- A bite or sting typically is a red lump which may have a hole in the center. You may have pain, swelling and a rash. Severe stings may cause a headache and an upset stomach (vomiting).
- Some individuals will have an allergic reaction to a bite or sting. Difficulty breathing or chest pain is an emergency requiring medical care.
- Elevation of the injured area and ice (applied to the area 10 to 20 minutes each hour) will decrease pain and swelling.
- Diphenhydramine (Benadryl) may be used as directed to control itching and hives.

Call or see a physician, go to the emergency department, or call 911 immediately if:

- You develop any chest pain or difficulty breathing.
- The area becomes red, warm, tender, and swollen beyond the area of the bite or sting.
- You develop a temperature above 101° F.

RESPIRATORY DISTRESS:

- Respiratory Distress is also known as shortness of breath or difficulty breathing.
- Causes of Respiratory Distress include reactions to pollen, dust, animals, molds, foods, drugs, infections, smoke, and respiratory conditions such as Asthma and COPD. If possible avoid any causes which produce respiratory distress.
- If you have seen a physician for this problem, take all medication's as directed.

Call or see a physician, go to the emergency department, or call 911 immediately if:

- Temperature is greater than 101° F.
- The cough, wheezing, or breathing difficulty becomes worse or does not improve even when taking medications.
- You have Chest Pain.
- Sputum (spit) changes from clear to yellow, green, grey, or becomes bloody.
- You are not able to perform normal activities.

EXTREMITY INJURY:

- Extremity Injuries may consist of cuts, scrapes, bruises, sprains, or broken bones (fractures).
- Apply ice on the injury for 15 to 20 minutes each hour for the first 1 to 2 days.
- Elevate the extremity above the heart as possible for the first 48 hours to decrease pain and swelling.
- Use the extremity as pain allows.

Call or see a physician, go to the emergency department, or call 911 immediately if:

- Temperature is greater than 101° F.
- The bruising, swelling, or pain gets worse despite the treatment listed above.
- Any problems listed on the Wound Care instructions are noted.
- You are unable to move the extremity or if numbness or tingling is noted.
- You are not improved in 24 to 48 hours or you are not normal in 7 to 10 days.

VOMITING/DIARRHEA:

- Vomiting (throwing up) can be caused by many things. It is common in children, but should be watched closely.
- Diarrhea is most often caused by either a food reaction or infection.
- Dehydration is the most serious problem associated with vomiting or diarrhea.
- Drink clear liquids such as water, apple juice, soft drinks, or gatorade for the first 12 hours or until things improve. Adults should drink 8 to 12 glasses of fluids per day with diarrhea. Children should drink 1 cup of fluid for each loose bowel movement.

Call or see a physician, go to the emergency department, or call 911 immediately if:

- Temperature is greater than 101° F.
- Vomiting or Diarrhea lasts longer than 24 hours, gets worse, or blood is noted.
- You cannot keep fluids down or no urination is noted in 8 hours.

WOUND CARE:

- Wounds include cuts, scrapes, bites, abrasions, or puncture wounds.
- If the wound begins to bleed, apply pressure over the wound with a clean bandage and elevate the wound above the heart for 5 to 10 minutes.
- Unless instructed otherwise, clean the wound twice daily with soapy water, and keep the wound dry. It is safe to take a shower but do not place the wound in bath or dish water.
- See a physician for a tetanus shot if it has been 10 years or more since your last one.

Call or see a physician, go to the emergency department, or call 911 immediately if:

- See the Extremity Injury instructions.
- Temperature is greater than 101° F.
- Bruising, swelling, or pain gets worse or bleeding is not controlled as directed above.
- Any signs of infection, such as redness, drainage of yellow fluid or pus, red streaks extending from the wound, or a bad smell is noted.

Abbreviations

A&O x3	alert and oriented to person, place, time
A&O x4	alter and oriented to person, place, time, current event
AB	abortion
AED	automated external defibrillator
AEMT	advanced EMT
AFib	atrial fibrillation
AAA	abdominal aortic aneurysm
ABC	airway, breathing, circulation
abd	abdominal
ACLS	advanced cardiac life support
AICD	automatic implanted cardioverter/defibrillator
AKA	above knee amputation
ALS	advanced life support
AMA	against medical advice
AMS	altered mental status
amt	amount
apap	acetaminophen
APGAR	appearance, pulse, grimace, activity, respirations
ARF	acute renal failure
asa	aspirin
assoc	associated
AVPU	alert, verbal, pain, unresponsive
BGL	blood glucose level
bl	bilateral
BKA	below knee amputation
BM	bowel movement
BLS	basic life support
BTLS	basic trauma life support
BP	blood pressure
BS	breath sounds
BSI	body substance isolation
BVM	bag-valve-mask
c	with
ca	cancer
CABG	coronary artery bypass graft
CAD	coronary artery disease
cath	catheter, catheterization
CC	chief complaint
CF	cystic fibrosis
CHF	congestive heart failure
cm	centimeters

CNS	central nervous system
C/O	complains of
CO	carbon monoxide
CO ₂	carbon dioxide
COPD	chronic obstructive pulmonary disease
CP	chest pain, cerebral palsy
CPAP	continuous positive airway pressure
CPR	cardiopulmonary resuscitation
CRI	chronic renal insufficiency
C/S	caesarean section
C-spine	cervical spine
CTA	clear to auscultation
CVA	cerebrovascular accident
D10	dextrose 10%
D/C	discontinue, discharge
DDx	differential diagnosis
defib	defibrillation
DJD	degenerative joint disease
DKA	diabetic ketoacidosis
DM	diabetes mellitus
DNR	do not resuscitate
DOA	dead on arrival
DOE	dyspnea on exertion
d/t	due to
DT	delirium tremens
DTR	deep tendon reflex
DVT	deep venous thrombosis
Dx	diagnosis
ECG	electrocardiogram
ED	emergency department
EDC	estimated date of confinement (due date)
EEG	electroencephalogram
EGA	estimated gestational age
EJ	external jugular
EKG	electrocardiogram
EMD	emergency medical dispatcher
EMS	emergency medical services
EMT	emergency medical technician
EOC	emergency operations center
EOMI	extra-ocular movements intact
ESLD	end stage liver disease
ESRD	end stage renal disease

ETA	estimated time of arrival
ETT	endotracheal tube
etOH	ethanol (alcohol)
ext	extremity, extension
FB	foreign body
FD	fire department
Fe	iron
Flex	flexion
Fx	fracture
G	Gravida
g	grams
GCS	Glasgow coma score
GERD	gastro-esophageal reflux disease
GI	gastrointestinal
GSW	gunshot wound
gtts	drops, drips
GU	genitourinary
GYN	gynecology, gynecological
H ₂ O	water
HA	headache
HazMat	hazardous materials
HCO ₃	bicarbonate
HEENT	head, eyes, ears, nose, throat
Hg	mercury
hosp	hospital
HPI	history of present illness
HR	heart rate
ht	height
HTN	hypertension
Hx	history
ICP	intracranial pressure
ICS	incident command system
ICU	intensive care unit
IDDM	insulin dependent diabetes mellitus
IM	intramuscular
IN	intranasal
IO	intraosseous
IV	intravenous
IVP	intravenous push
IVPB	intravenous piggyback

J	joule
JVD	jugular venous distension
K+	potassium
KED	Kendrick extrication device
kg	kilograms
KVO	keep vein open
L	left
L&D	labor and delivery
lat	lateral
LAD	left axis deviation
LAE	left atrial enlargement
lb	pound
LBBB	left bundle branch block
LLQ	left lower quadrant
LMP	last menstrual period
LOC	loss of consciousness, level of consciousness
LPN	licensed practical nurse
L-spine	lumbar spine
L/S-spine	lumbosacral spine
LUQ	left upper quadrant
LVH	left ventricular hypertrophy
MAE	moves all extremities
MAL	mid axillary line
MAP	mean arterial pressure
MCC	motor cycle crash
MCI	mass casualty incident
MCL	midclavicular line
MD	medical doctor, muscular dystrophy
MDI	metered dose inhaler
mcg	micrograms
mEq	milli-equivalents
MgSO ₄	magnesium sulfate
mg	milligrams
MI	myocardial infarction
min	minutes
ml	milliliters
mm	millimeters
MOI	mechanism of injury
MRSA	methicillin resistant staph aureus
MS	multiple sclerosis
MVC	motor vehicle crash

N ₂ O	nitrous oxide
Na ⁺	sodium
N/A	not applicable, not available
NAD	no apparent distress
neb	nebulizer
NG	nasogastric
NKDA	no known drug allergies
nl	normal
N/V/D	nausea/vomiting/diarrhea
NC	nasal cannula
NP	nurse practitioner
NPA	nasopharyngeal airway
NPO	nothing by mouth
NRB	non-rebreather mask
NS	normal saline
NSAID	non-steroidal anti-inflammatory drug
NSR	normal sinus rhythm
NT/ND	nontender/nondistended
ntg	nitroglycerin
NVID	neurovascularly intact distally
O ₂	oxygen
OB	obstetric, obstetrical
OCP	oral contraceptive pill
OD	overdose
OPA	oropharyngeal airway
OR	operating room
OTC	over-the-counter
P	pulse, parity
p	after
PA	physician's assistant
PAC	premature atrial contraction
palp	palpation
PALS	pediatric advanced life support
PCN	penicillin
PCR	patient care report
PD	police department
PE	pulmonary embolus; physical exam
PEA	pulseless electrical activity
PEARL	pupils equal and reactive to light
PMH	past medical history
PND	paroxysmal nocturnal dyspnea
PO	orally, by mouth
POV	privately owned vehicle

ppd	packs per day
PPE	personal protective equipment
PPM	parts per million
PRN	as needed
PROM	pre-mature rupture of membranes
PSVT	paroxysmal supraventricular tachycardia
Pt	patient
PTA	prior to arrival
PTL	pre-term labor
PUD	peptic ulcer disease
PVC	premature ventricular contraction
PVD	peripheral vascular disease
Q	every
RAD	right axis deviation
RBBB	right bundle branch block
RLQ	right lower quadrant
RN	registered nurse
r/o	rule out
RR	respiratory rate
RUQ	right upper quadrant
Rx	prescription, medication
rxn	reaction
s	without
SA	sino-atrial
SB	sinus bradycardia
SBP	systolic blood pressure
SL	sublingual
SNF	skilled nursing facility
Sn/Sx	signs/symptoms
SOB	shortness of breath
S/P	status post
SpO ₂	pulse oxygen saturation
SQ	subcutaneous
SROM	spontaneous rupture of membranes
SSS	sick sinus syndrome
ST	sinus tachycardia
S/T	sore throat
STD	sexually transmitted disease
STEMI	ST-segment elevation myocardial infarction
SVD	spontaneous vaginal delivery
SVT	supraventricular tachycardia
Sz	seizure

T	temperature
tab	tablet
Tb	tuberculosis
TBSA	total body surface area
TCP	transcutaneous pacing
TM	tympanic membrane
T-spine	thoracic spine
TIA	transient ischemic attack
TKO	to keep open
Tx	treatment, transport, traction
UA	unstable angina
UOA	upon our arrival
URI	upper respiratory infection
UTI	urinary tract infection
VF	ventricular fibrillation
V/S	vital signs
VT	ventricular tachycardia
WCT	wide complex tachycardia
WD/WN	well developed/well nourished
WNL	within normal limits
WPW	Wolf-Parkinson-White
wt	weight
yo	years old
~	approximately
Δ	change
=	equal to
≠	not equal to
>	greater than
<	less than
∅	no, not, negative
⊖	negative
+	positive
?	questionable
1°	primary
2°	secondary
3°	tertiary
ψ	psychiatric

Local Credentialing Requirements

Initial Local Credentialing Requirements:

- * EMT-Basic
 - Successfully obtain North Carolina state credentials prior to beginning FTO ride time requirements
 - Successfully complete all Field Training Officer (FTO) requirements
 - Successfully complete basic written examination
 - Successfully complete basic psychomotor skill stations
 - Successfully complete the Agency's local credentialing examination (Scope of Practice simulation scenarios)
- * EMT-Paramedic
 - Successfully obtain North Carolina state credentials prior to beginning FTO ride time requirements
 - Successfully complete all Field Training Officer (FTO) requirements
 - Successfully complete advanced written examination
 - Successfully complete advanced psychomotor skill stations
 - Successfully complete the Agency's local credentialing examination (Scope of Practice simulation scenarios)
 - Successfully complete the oral board examination as administered by the medical director or EMS fellow

Renewal of Local Credentials (Every 4 years):

- * EMT-Basic
 - Complete all required/mandatory continuing education
 - Successfully complete basic written examination
 - Successfully complete basic psychomotor skill stations
 - Successfully complete the Agency's local credentialing examination (Scope of Practice simulation scenarios)
- * EMT-Paramedic
 - Complete all required/mandatory continuing education
 - Successfully complete advanced written examination
 - Successfully complete advanced psychomotor skill stations
 - Successfully complete the Agency's local credentialing examination (Scope of Practice simulation scenarios)
- * Completing the continuing education requirements will allow the employee to recertify their NC State credentials
 - Scope of Practice examinations will allow the employee to recertify their local credentials and provide care in Mecklenburg County
 - Failure to successfully pass the local credentialing examinations prior to the expiration date printed on the employee's NC certification card will result in the inability to practice in Mecklenburg County, even if their certification has been renewed at the state level

Internal Upgrade Requirements

EMT to Paramedic upgrade

- * Obtain North Carolina Paramedic certification
 - Employee must have graduated from an accredited Paramedic program
 - If the employee did not graduate from an accredited program, they will be required to complete a state approved refresher course prior to moving forward with the upgrade process
- * The request to upgrade must be received within 6-months (180-days) of Paramedic credential being issued by the North Carolina Office of EMS
 - All requirements for internal upgrade must be completed within 12-months (365-days) of Paramedic credential being issued by NCOEMS
 - If unsuccessful at completing all requirements for internal upgrade within 12-months (365-days), the provider must complete an approved refresher course prior to moving forward with the upgrade process
 - If requesting upgrade outside of 6-months (180-days) from Paramedic credential being issued by NCOEMS, the provider must complete an approved refresher course prior to moving forward with the upgrade process

Mechanism of upgrade

- * EMT will make the formal request to upgrade to their assigned Operations Supervisor
- * EMT must be current on all required/mandatory continuing education
- * Successfully complete all Field Training Officer (FTO) requirements
 - Must be completed in ≤ 4 weeks
- * Successfully complete advanced written examination
- * Successfully complete advanced psychomotor skill stations
- * Successfully complete the Agency's local credentialing examination (Scope of Practice simulation scenarios)
- * Successfully complete the oral board examination as administered by the medical director or EMS fellow

Note:

- * *Each provider will be afforded two (2) opportunities to successfully complete each testing requirement (written, psychomotor, simulation, and oral board)*
- * *Failure to successfully complete any portion of the testing within two attempts will require completion of an approved paramedic refresher course prior to any additional testing*
- * *Time can be scheduled to meet with Clinical Improvement Analysts and/or Education Specialists for provider review/education prior any testing attempts*

Continuing Education Requirements

All Provider Levels

- * The Agency will provide continuing education classes which meet the yearly requirements set by the North Carolina Office of Emergency Medical Services (NCOEMS)
 - Classes may include but are not limited to: classroom learning, simulation, distance learning or on-line requirements
- * It is the responsibility of each individual to attend continuing education to satisfy Agency and NCOEMS requirements
- * All continuing education provided by the Agency is a requirement for each employee
 - Certain required continuing education offerings will be designated as mandatory for all credentialed employees
 - Examples of mandatory training may include: Introduction of new equipment/medications, protocol changes or changes to the provider's scope of practice
- * If unable to attend a required or mandatory continuing education session you must contact a member of Medical Services and your direct supervisor
- * Employees completing make-up sessions will be paid their hourly rate (or time and a half) for class hours
- * Sessions that consisted of a hands-on or skills demonstration component may not be available for make-up
 - Subsequently, the employee will not be able to obtain the missed continuing education hours

Designated Mandatory Sessions

- * An employee must attend a make-up session for any missed mandatory continuing education session within 30 days of the final scheduled offering
- * An employee who is non-compliant after 30 days *will be removed from the schedule* in a LWOP status until the mandatory session has been completed
- * If the employee was on approved leave and/or excused from in-service, then the mandatory content must be completed prior to returning to duty
- * For those employees who are unable to attend a required session or excused for extended periods (e.g. due to illness, injury, vacation), Medical Services will offer and schedule make-up sessions
 - Employees out for extended periods should refer to the extended leave policy below for a list of requirements

Return to Field Requirements

Introduction

- * Under certain circumstances employees may be excused from field duty for extended periods (e.g. illness or injury, vacation)
- * Depending upon the length of absence, requirements must be completed to return to duty
- * These are outlined below for all provider levels (EMT, Advanced EMT, Paramedic)

≤ 3 Months

- * All deficient continuing education sessions/administrative/operations items must be completed PRIOR to returning to duty
- * The employee may request to ride in a 3rd person status to re-acclimate to the field
 - This will be at the discretion of operations

3 Months to 6 Months

- * All deficient continuing education sessions/administrative/operations items must be completed PRIOR to returning to duty
- * Successfully complete the Agency's local credentialing examination (Scope of Practice)
 - Basic/Advanced written examination portion only
- * The employee may request to ride in a 3rd person status to re-acclimate to the field
 - This will be at the discretion of operations.

6 Months to 1 year

- * All deficient continuing education sessions/administrative/operation items must be completed PRIOR to returning to duty
- * Successfully complete the Agency's local credentialing examination (Scope of Practice)
 - Basic/Advanced written examination
 - Basic/Advanced psychomotor skill stations
- * Successfully complete the oral board examination as administered by the medical director or EMS fellow (Paramedics Only)
- * The employee may request to ride in a 3rd person status to re-acclimate to the field
 - This will be at the discretion of operations

1 Year or Greater

- * Successfully complete an initial NC EMT course or state approved Paramedic Refresher Course depending on level of certification
- * Successfully complete all Field Training Officer (FTO) requirements
 - Maximum of 4 weeks
- * Successfully complete the Agency's local credentialing examination (Scope of Practice)
 - Basic/Advanced written examination
 - Basic/Advanced psychomotor skill stations
 - Successfully complete the oral board examination as administered by the medical director or EMS fellow (Paramedics Only)

Clinical Performance Measures

Introduction

- * The department of Medical Services is responsible for providing clinical continuing education and training for all certified medical providers (EMT, AEMT, and Paramedic)
- * The department is also responsible for the identification of didactic and/or skill competency concerns, formulate a corrective plan of action, and provide remediation of providers as needed
- * Medical Services monitors clinical quality performance through retrospective review of patient care reports and data analysis of clinical measures - supporting the Agency's quality improvement functions and clinical research efforts

Medical Services Clinical Performance and Proficiency Evaluation Mechanisms

- * Assesses EMT, AEMT, and Paramedic core knowledge and skill competency through the use of validated scenarios, which interact with advanced technology human patient simulators, against a realistic setting/environment
- * Evaluation of field personnel performance through ride along observations
- * Retrospective quality review of electronic patient care report data for selected priorities and categories
- * Evaluation of new employee candidates through the Assessment Center process by assessing medical knowledge, psychomotor skill sets, and affect and makes recommendation for hiring based on clinical and educational expertise
- * Medical incidents reviews
 - Represents Medical Services in the medical incident review processes
 - Provides resultant remediation
 - Track, document and report remedial training progress to the Medical Director

Medical Services Performance and Proficiency Tools

- * Development and implementation of assessment tools used in the evaluation of current employees for clinically related promotional processes
- * Development and implementation of various assessment models which evaluate the clinical competency of patient care providers to maintain local credentialing
- * Remedial training, verbal and written coaching for those medics who are identified as in need through simulation, testing and/or quality improvement processes

Interval Clinical Performance Measures

- * Clinical Quality Data Sets-
 - Seizures
 - Dispatch complaint and Primary Impression = Seizure
 - Appropriate treatment = midazolam (Versed®) administration
 - Dispatch complaint and Primary Impression = Seizure
 - Appropriate treatment = blood glucose level
 - STEMI
 - Patient appears in STEMI database
 - Appropriate treatment = aspirin, aspirin allergy, or aspirin PTA
 - Appropriate treatment = ECG acquired
 - Bronchospasm
 - Respiratory distress with history of Asthma or symptom of wheezing
 - Appropriate treatment = albuterol or albuterol PTA
 - Pulmonary Edema
 - Patient with pulmonary edema specified in "symptoms"
 - Appropriate treatment = nitroglycerin or contraindication of 1st SBP <90 or Medications: sildenafil, tadalafil, or vardenafil
 - Appropriate treatment = NIPPV (CPAP)
 - Priority-1 trauma scene times
 - STEMI
 - True STEMI vs. false activation
 - 911 to PCI time
 - Radio notification to PCI time
 - Depart scene to catheterization lab table time
 - Cardiac arrest
 - Utstein ROSC rates
 - Non- Utstein ROSC rates
 - Post-ROSC 12-lead ECG acquired
 - Elapsed time 911-call to first defibrillation
 - Elapsed time ROSC to depart scene
 - Priority 1, 2, 3, 4 response times

COVID-19 Specific High Consequence Pathogen Supplement

Introduction

- * Differential diagnosis
 - Influenza
 - Bacteremia/septicemia
- * Transmission occurs via contact with respiratory droplets of infected individuals:
 - Between people who are in close contact with one another
 - ~ 3 – 6 feet for ≥ 10 minutes
 - COVID-19
 - It may be possible that a person can get COVID-19 by touching contaminated surface or object that has the virus on it and then touching their own mouth, nose, or eyes
 - This is not believed to be the main way the virus spreads
- * Symptoms:
 - Fever ($>100.4^{\circ}\text{F}$)
 - Cough/upper respiratory illness symptoms
 - Difficulty breathing or shortness of breath
 - New loss of sense of taste &/or smell
 - Chills/myalgias
 - Nausea/vomiting/diarrhea
 - New onset headache
 - Rhinorrhea
 - Sore throat
- * Persons that should be considered high risk
 - Influenza-like illness = temp > 100.4 (or have taken an antipyretic in past 4-6 hours)
 - Plus, one of the following:
 - Cough
 - Shortness of breath
 - Known exposure to person with COVID-19 or person under investigation (PUI) within past 14 days

Basic / Advanced Medical Care

1. Screening on scene should take place for ALL patients (medical and trauma)
2. Surgical mask should be placed on all patients regardless of screening results
3. EMS personnel should don personal protective equipment (PPE) with any patient with a positive field screen as soon as identified utilizing standard donning procedures for airborne/droplet precautions
 - A. Eye protection (goggles / face shield)
 - B. Fluid impervious gown
 - C. Gloves
 - D. N-95 mask (surgical mask may be utilized if N-95 mask is not available)
4. For CMED EIDS screen positive – one provider should don a surgical mask with face shield
 - A. Ensure the patient dons the surgical mask
 - B. Perform a Field Screen within 5 minutes to verify EIDS status
 - C. For field screen positive ALL care providers who will be within 6 feet of patient don full PPE
 - D. For field screen negative follow standard PPE guidelines
5. Temperature must be assessed on ALL patients
6. Only essential personnel should have any contact with the patient
7. First responder personnel should **NOT** have patient contact unless critical intervention / assistance required
8. Contact operations supervisor as soon as a patient with a positive screen is identified
9. [Medical Initial Assessment Protocol](#) or [Pediatric Initial Assessment Protocol](#)
10. Care as per appropriate protocol
11. Avoid the aerosolizing procedures if not distinctly indicated
 - A. Nebulizer treatments, suctioning, high flow nasal cannula, CPAP, SGD, BVM, ETT
 - B. **If any aerosolizing procedure is required, PPE as above with an N-95 mask must be utilized**
 - C. Avoid attempts at endotracheal intubation
12. If supplemental oxygen is required a non-rebreather mask should be utilized
 - A. Surgical mask should be placed over the NRB mask
13. Limit utilized equipment to only essential equipment required for needed patient care
14. With negative screen provide care as per appropriate protocol and transport per patient destination general triage protocol
15. During encode notify receiving emergency department of "EIDS positive patient"
16. If nebulizer is being utilized, this should be halted and held upon arrival to the emergency department until the patient has been placed in their treatment room
17. Use of CPAP must be discussed with the receiving facility prior to arrival and plan for patient transition from ambulance to treatment room clarified prior to arrival
 - A. This may include momentary halting of CPAP during patient movement

Additional Considerations

- * Driver of transporting ambulance should wear PPE as described above when participating in patient care activities (including patient transport & loading)
 - Remove PPE except for N-95 (or surgical mask) and perform hand hygiene prior to entering vehicle cab to prevent contamination of driver's compartment
- * CMED will screen at call-taking (CMED will advise "Positive EIDS patient" if positive screen)
 - It is imperative that field providers also ask screening questions on scene
- * Transport of patient with suspected high consequence pathogen must be reported to Operations Supervisor
 - Must be reported to local public health authorities
 - Ensure Supervisor and Public health notified of any patient who refuses transport or is pronounced dead on scene (if positive screen for a high consequence pathogen)
- * Extreme care should be utilized in doffing PPE post transport per standard procedure to ensure no contamination from exposure to used PPE
 - Do not touch outer surface of PPE
 - Do not remove N-95 mask or eye protection prior to gown/coverall removal
- * No family members or bystanders should be transported in the ambulance
- * Appropriate PPE is required during cleaning / disinfecting of any EMS equipment
 - Utilize appropriate approved disinfectant cleansing solution
 - Equipment includes ambulance interior and surfaces exposed to patient contact
- * Following patient care activity utilize standard hand hygiene utilizing soap and water for 30 seconds or alcohol-based hand sanitizer
- * If any personnel exposure occurs Supervisor will perform a risk assessment and notify employee health as soon as indicated following decontamination / cleansing / irrigation of exposure
- * Recommended to wear surgical mask and consider eye protection for any patient with fever; even outside this protocol
- * Negative Pressure in care compartment:
 - For door or window available to separate driver's and care compartment space:
 - Close door/window between driver's and care compartment
 - Operate rear exhaust fan on full
 - For no door or window available to separate driver's and care compartment space:
 - Open outside air vent in driver's compartment and set rear exhaust fan to full
 - Set vehicle ventilation system to non-recirculating to bring in maximum outside air

COVID-19 Focused Cardiac Arrest Supplement

Introduction

- * This supplement is to be utilized in conjunction with the primary Focused Cardiac Arrest and COVID-19 protocols
- * Goal will be to minimize provider exposure to a possible patient with undiagnosed COVID-19 while acknowledging the challenge of identifying these patients given their critical status
- * The primary route of exposure to COVID-19 is the inhalation of infected respiratory droplets
- * Resuscitative efforts involve several Aerosol-Generating Procedures; including:
 - o Intubation, extubation and related procedures
 - o Manual Ventilation
 - o Open Suctioning
- * Presently the CDC and the AHA recommend that providers utilize the following PPE when involved in resuscitation:
 - o Respirator (N95) or facemask if respirator is not available
 - o Eye protection
 - o Gloves
 - o Gowns
- * All patients in cardiac arrest must be assumed to potentially be COVID-19 positive

Basic / Advanced Medical Care

1. All personnel participating in providing CPR MUST wear full PPE when performing resuscitative efforts to include:
 - A. N95 mask
 - B. Face shield
 - C. Gloves
 - D. Fluid impervious gown
2. For patients with reported witnessed arrest PPE should be in place as to not delay resuscitative efforts
3. For patients believed to be an obvious death (unwitnessed with likely prolonged downtime) and no resuscitative measures are going to be initiated full protective measures do not need to be worn to assess for rigor mortis, dependent lividity, cold temperature (standard PPE should be utilized)
 - A. If subsequently determined patient does not meet obvious death criteria, compression only CPR should be initiated while full PPE as above is donned by other providers
 - i. Covering in the form of cloth or surgical mask should be placed over the patient's mouth & nose during compression only CPR
 - B. Providers assessing for obvious death on a pulseless and apneic patient, should, at minimum, wear standard PPE
4. For patients with EMS witnessed cardiac arrest perform compression only CPR utilizing standard PPE until full PPE is donned then proceed with focused cardiac arrest care
 - A. Covering in the form of cloth or surgical mask should be placed over the patient's mouth & nose during compression only CPR
5. Only personnel required to perform resuscitative efforts should be in the room with the patient
 - A. FD Captain should also be in full PPE in order to provide appropriate feedback coaching related to compressions and ventilations during the resuscitation
6. All others on choosing to remain on scene should remain > 6 feet from patient/providers
 - A. e.g. family, police, others
7. Performance of cardiac arrest care:
 - A. Insert BIAD airway via standard method
 - B. Avoid any BVM attempts prior to BIAD placement
 - C. Place defibrillator pads and QCPR device
8. A cloth or towel may be utilized to assist with managing excess secretions
9. Establish IO and administer fluids/medications as indicated

Post Resuscitation Care

- * ROSC is achieved:
 - Continue with post ROSC standard procedures
 - Obtain a temporal temperature measurement
- * Immediately notify the receiving hospital that you are enroute with a ROSC patient
- * NO ROSC achieved and patient pronounced on scene
 - Ensure supervisor notified
 - Ensure public health notified as indicated

Additional Considerations

- * Following termination of resuscitative efforts or delivery of the patient to the ED doff PPE utilizing standard precautions
- * Resources:
 - <https://www.medpagetoday.com/infectiousdisease/covid19/85568>
 - <https://www.medscape.com/viewarticle/927389>
 - https://www.cdc.gov/coronavirus/2019-ncov/infection-control/control-recommendations.html?CDC_AA_refVal=https%3A%2F%2Fwww.cdc.gov%2Fcoronavirus%2F2019-ncov%2Fhcp%2Finfection-control.html#take_precautions
 - Cardiac Arrest COVID-19 Protocol Carolinas Medical Center Department of Emergency Medicine, COVID-19 EM Clinical Care Task Force

Monkeypox

Introduction

- * Viral disease caused by infection with the monkeypox virus
 - Virus is part of the same family of viruses as variola virus (virus causing smallpox)
- * Symptoms are similar to smallpox symptoms, but milder and rarely fatal
- * Monkeypox is not related to chickenpox
- * Incubation period: 7 – 14 days
- * Illness duration: 2 – 4 weeks
 - Can be spread from the time symptoms start until the rash has fully healed and a fresh layer of skin has formed
- * Spread
 - Large respiratory droplets
 - Typically during prolonged, face-to-face contact, or during intimate physical contact (kissing, cuddling, or sex)
 - Direct contact with lesions
 - Direct contact with bodily fluids or contaminated clothing/bedding
 - Direct contact with infected animals / animal products

Signs and Symptoms

- * Fever/chills
 - Typically occurs 1 – 2 days prior to rash development
- * Rash
 - Well circumscribed vesicles/pustules
 - May be fluid or pus filled
 - Typically same size and same stage on a single site
 - Typically more lesions on extremities and face vs. torso
 - Lesions may occur on palms and soles
 - Lesions scab over & resolve
- * Enlarged lymph nodes
- * Fatigue
- * Headache
- * Myalgias

Screening for Presumptive Impression

- * Reported contact with person with a similar rash or diagnosed with monkeypox
- * Seeking care for rash associated with possible sexually transmitted infection (STI)
 - Genital lesions
- * Close contact with individuals in a social network experiencing a monkey pox outbreak
 - Men who have sex with men
 - Partners meeting through online websites, digital apps, or party/bar
- * Travel outside U.S. to country with confirmed cases of monkeypox

Personal Protection Equipment

- * N95 or equivalent
- * Gloves
- * Gown
- * Eye protection

Management

1. EMS personnel should don standard personal protective equipment (PPE)
2. Screening questions should be noted for any patient with a chief complaint of fever and/or rash (see above)
3. EMS personnel should don appropriate additional personal protective equipment (PPE) with any patient with a positive field screen (symptoms or known exposure) as soon as identified utilizing standard donning procedures for airborne/droplet precautions
4. Surgical mask should be placed on all patients
5. Contact operations supervisor as soon as a patient with a positive screen is identified
6. **Medical Initial Assessment Protocol** or **Pediatric Initial Assessment Protocol**
7. Maintain airway; suction as needed
8. Assess vital signs
9. Provide supplemental oxygen per patient condition to maintain SpO₂ = 94 – 97%
10. Provide assisted ventilations with bag-valve mask and 100% oxygen if breathing or ventilatory compromise is apparent
11. Assess blood glucose level
 - A. Oral glucose for hypoglycemia and patient alert with intact gag reflex
12. Acetaminophen for fever
 - A. Adults: 650 mg – 975 mg orally
 - B. Pediatrics: 15 mg/kg orally (> 3-months of age; maximum 975mg)

Additional Considerations

- * Ensure encode to the receiving emergency department includes presumptive suspicion of monkeypox
- * Do not shake any potentially contaminated bedding
- * Disinfect all surfaces utilizing standard disinfection practices
- * Clinical care for monkeypox involves supportive care and isolation practices
 - There is no recommendation for antiviral therapy
 - There is no recommendation for immunoglobulin therapy
 - Vaccine is available for post exposure in high risk individuals
 - Immunocompromised
 - Pediatric patients younger than 8 years of age
 - Atopic dermatitis or other active exfoliative skin conditions
 - Pregnant or breastfeeding women
 - Secondary bacterial skin infection
 - Other significant comorbidities

Rash



*This
Page
Blank*



Provider Notes

Notes

Notes



Medical Excellence. Compassionate Care.